

FANUC Series 16*i*/160*i*/160*is*-MODEL B

FANUC Series 18*i*/180*i*/180*is*-MODEL B

FANUC Series 21*i*/210*i*/210*is*-MODEL B

FANUC Series 20*i*-MODEL B

DESCRIPTIONS

- No part of this manual may be reproduced in any form.
- All specifications and designs are subject to change without notice.

The export of this product is subject to the authorization of the government of the country from where the product is exported.

In this manual we have tried as much as possible to describe all the various matters. However, we cannot describe all the matters which must not be done, or which cannot be done, because there are so many possibilities. Therefore, matters which are not especially described as possible in this manual should be regarded as "impossible".

This manual contains the program names or device names of other companies, some of which are registered trademarks of respective owners. However, these names are not followed by ® or ™ in the main body.

SAFETY PRECAUTIONS

This section describes the safety precautions related to the use of CNC units. It is essential that these precautions be observed by users to ensure the safe operation of machines equipped with a CNC unit (all descriptions in this section assume this configuration). Note that some precautions are related only to specific functions, and thus may not be applicable to certain CNC units.

Users must also observe the safety precautions related to the machine, as described in the relevant manual supplied by the machine tool builder. Before attempting to operate the machine or create a program to control the operation of the machine, the operator must become fully familiar with the contents of this manual and relevant manual supplied by the machine tool builder.

Contents

1. DEFINITION OF WARNING, CAUTION, AND NOTE	s-2
2. GENERAL WARNINGS AND CAUTIONS	s-3
3. WARNINGS AND CAUTIONS RELATED TO PROGRAMMING	s-5
4. WARNINGS AND CAUTIONS RELATED TO HANDLING	s-7
5. WARNINGS RELATED TO DAILY MAINTENANCE	s-9

1

DEFINITION OF WARNING, CAUTION, AND NOTE

This manual includes safety precautions for protecting the user and preventing damage to the machine. Precautions are classified into Warning and Caution according to their bearing on safety. Also, supplementary information is described as a Note. Read the Warning, Caution, and Note thoroughly before attempting to use the machine.

WARNING

Applied when there is a danger of the user being injured or when there is a danger of both the user being injured and the equipment being damaged if the approved procedure is not observed.

CAUTION

Applied when there is a danger of the equipment being damaged, if the approved procedure is not observed.

NOTE

The Note is used to indicate supplementary information other than Warning and Caution.

- **Read this manual carefully, and store it in a safe place.**

2 GENERAL WARNINGS AND CAUTIONS

WARNING

1. Never attempt to machine a workpiece without first checking the operation of the machine. Before starting a production run, ensure that the machine is operating correctly by performing a trial run using, for example, the single block, feedrate override, or machine lock function or by operating the machine with neither a tool nor workpiece mounted. Failure to confirm the correct operation of the machine may result in the machine behaving unexpectedly, possibly causing damage to the workpiece and/or machine itself, or injury to the user.
2. Before operating the machine, thoroughly check the entered data. Operating the machine with incorrectly specified data may result in the machine behaving unexpectedly, possibly causing damage to the workpiece and/or machine itself, or injury to the user.
3. Ensure that the specified feedrate is appropriate for the intended operation. Generally, for each machine, there is a maximum allowable feedrate. The appropriate feedrate varies with the intended operation. Refer to the manual provided with the machine to determine the maximum allowable feedrate. If a machine is run at other than the correct speed, it may behave unexpectedly, possibly causing damage to the workpiece and/or machine itself, or injury to the user.
4. When using a tool compensation function, thoroughly check the direction and amount of compensation. Operating the machine with incorrectly specified data may result in the machine behaving unexpectedly, possibly causing damage to the workpiece and/or machine itself, or injury to the user.
5. The parameters for the CNC and PMC are factory-set. Usually, there is not need to change them. When, however, there is not alternative other than to change a parameter, ensure that you fully understand the function of the parameter before making any change. Failure to set a parameter correctly may result in the machine behaving unexpectedly, possibly causing damage to the workpiece and/or machine itself, or injury to the user.
6. Immediately after switching on the power, do not touch any of the keys on the MDI panel until the position display or alarm screen appears on the CNC unit. Some of the keys on the MDI panel are dedicated to maintenance or other special operations. Pressing any of these keys may place the CNC unit in other than its normal state. Starting the machine in this state may cause it to behave unexpectedly.
7. The operator's manual and programming manual supplied with a CNC unit provide an overall description of the machine's functions, including any optional functions. Note that the optional functions will vary from one machine model to another. Therefore, some functions described in the manuals may not actually be available for a particular model. Check the specification of the machine if in doubt.

WARNING

8. Some functions may have been implemented at the request of the machine-tool builder. When using such functions, refer to the manual supplied by the machine-tool builder for details of their use and any related cautions.

CAUTION

1. Do not remove the internal parts, including the ATA card and compact flash card, from within the CNC.

NOTE

Programs, parameters, and macro variables are stored in nonvolatile memory in the CNC unit. Usually, they are retained even if the power is turned off. Such data may be deleted inadvertently, however, or it may prove necessary to delete all data from nonvolatile memory as part of error recovery.

To guard against the occurrence of the above, and assure quick restoration of deleted data, backup all vital data, and keep the backup copy in a safe place.

3

WARNINGS AND CAUTIONS RELATED TO PROGRAMMING

This section covers the major safety precautions related to programming. Before attempting to perform programming, read the supplied operator's manual and programming manual carefully such that you are fully familiar with their contents.

WARNING

1. Coordinate system setting

If a coordinate system is established incorrectly, the machine may behave unexpectedly as a result of the program issuing an otherwise valid move command.

Such an unexpected operation may damage the tool, the machine itself, the workpiece, or cause injury to the user.

2. Positioning by nonlinear interpolation

When performing positioning by nonlinear interpolation (positioning by nonlinear movement between the start and end points), the tool path must be carefully confirmed before performing programming.

Positioning involves rapid traverse. If the tool collides with the workpiece, it may damage the tool, the machine itself, the workpiece, or cause injury to the user.

3. Function involving a rotation axis

When programming polar coordinate interpolation or normal-direction (perpendicular) control, pay careful attention to the speed of the rotation axis. Incorrect programming may result in the rotation axis speed becoming excessively high, such that centrifugal force causes the chuck to lose its grip on the workpiece if the latter is not mounted securely.

Such mishap is likely to damage the tool, the machine itself, the workpiece, or cause injury to the user.

4. Inch/metric conversion

Switching between inch and metric inputs does not convert the measurement units of data such as the workpiece origin offset, parameter, and current position. Before starting the machine, therefore, determine which measurement units are being used. Attempting to perform an operation with invalid data specified may damage the tool, the machine itself, the workpiece, or cause injury to the user.

5. Constant surface speed control

When an axis subject to constant surface speed control approaches the origin of the workpiece coordinate system, the spindle speed may become excessively high. Therefore, it is necessary to specify a maximum allowable speed. Specifying the maximum allowable speed incorrectly may damage the tool, the machine itself, the workpiece, or cause injury to the user.

WARNING**6. Stroke check**

After switching on the power, perform a manual reference position return as required. Stroke check is not possible before manual reference position return is performed. Note that when stroke check is disabled, an alarm is not issued even if a stroke limit is exceeded, possibly damaging the tool, the machine itself, the workpiece, or causing injury to the user.

7. Tool post interference check

A tool post interference check is performed based on the tool data specified during automatic operation. If the tool specification does not match the tool actually being used, the interference check cannot be made correctly, possibly damaging the tool or the machine itself, or causing injury to the user.

After switching on the power, or after selecting a tool post manually, always start automatic operation and specify the tool number of the tool to be used.

8. Absolute/incremental mode

If a program created with absolute values is run in incremental mode, or vice versa, the machine may behave unexpectedly.

9. Plane selection

If an incorrect plane is specified for circular interpolation, helical interpolation, or a canned cycle, the machine may behave unexpectedly. Refer to the descriptions of the respective functions for details.

10. Torque limit skip

Before attempting a torque limit skip, apply the torque limit. If a torque limit skip is specified without the torque limit actually being applied, a move command will be executed without performing a skip.

11. Programmable mirror image

Note that programmed operations vary considerably when a programmable mirror image is enabled.

12. Compensation function

If a command based on the machine coordinate system or a reference position return command is issued in compensation function mode, compensation is temporarily canceled, resulting in the unexpected behavior of the machine.

Before issuing any of the above commands, therefore, always cancel compensation function mode.

4 WARNINGS AND CAUTIONS RELATED TO HANDLING

This section presents safety precautions related to the handling of machine tools. Before attempting to operate your machine, read the supplied operator's manual and programming manual carefully, such that you are fully familiar with their contents.

WARNING

1. Manual operation

When operating the machine manually, determine the current position of the tool and workpiece, and ensure that the movement axis, direction, and feedrate have been specified correctly. Incorrect operation of the machine may damage the tool, the machine itself, the workpiece, or cause injury to the operator.

2. Manual reference position return

After switching on the power, perform manual reference position return as required. If the machine is operated without first performing manual reference position return, it may behave unexpectedly. Stroke check is not possible before manual reference position return is performed. An unexpected operation of the machine may damage the tool, the machine itself, the workpiece, or cause injury to the user.

3. Manual numeric command

When issuing a manual numeric command, determine the current position of the tool and workpiece, and ensure that the movement axis, direction, and command have been specified correctly, and that the entered values are valid.

Attempting to operate the machine with an invalid command specified may damage the tool, the machine itself, the workpiece, or cause injury to the operator.

4. Manual handle feed

In manual handle feed, rotating the handle with a large scale factor, such as 100, applied causes the tool and table to move rapidly. Careless handling may damage the tool and/or machine, or cause injury to the user.

5. Disabled override

If override is disabled (according to the specification in a macro variable) during threading, rigid tapping, or other tapping, the speed cannot be predicted, possibly damaging the tool, the machine itself, the workpiece, or causing injury to the operator.

6. Origin/preset operation

Basically, never attempt an origin/preset operation when the machine is operating under the control of a program. Otherwise, the machine may behave unexpectedly, possibly damaging the tool, the machine itself, the tool, or causing injury to the user.

WARNING**7. Workpiece coordinate system shift**

Manual intervention, machine lock, or mirror imaging may shift the workpiece coordinate system. Before attempting to operate the machine under the control of a program, confirm the coordinate system carefully.

If the machine is operated under the control of a program without making allowances for any shift in the workpiece coordinate system, the machine may behave unexpectedly, possibly damaging the tool, the machine itself, the workpiece, or causing injury to the operator.

8. Software operator's panel and menu switches

Using the software operator's panel and menu switches, in combination with the MDI panel, it is possible to specify operations not supported by the machine operator's panel, such as mode change, override value change, and jog feed commands.

Note, however, that if the MDI panel keys are operated inadvertently, the machine may behave unexpectedly, possibly damaging the tool, the machine itself, the workpiece, or causing injury to the user.

9. Manual intervention

If manual intervention is performed during programmed operation of the machine, the tool path may vary when the machine is restarted. Before restarting the machine after manual intervention, therefore, confirm the settings of the manual absolute switches, parameters, and absolute/incremental command mode.

10. Feed hold, override, and single block

The feed hold, feedrate override, and single block functions can be disabled using custom macro system variable #3004. Be careful when operating the machine in this case.

11. Dry run

Usually, a dry run is used to confirm the operation of the machine. During a dry run, the machine operates at dry run speed, which differs from the corresponding programmed feedrate. Note that the dry run speed may sometimes be higher than the programmed feed rate.

12. Cutter and tool nose radius compensation in MDI mode

Pay careful attention to a tool path specified by a command in MDI mode, because cutter or tool nose radius compensation is not applied. When a command is entered from the MDI to interrupt in automatic operation in cutter or tool nose radius compensation mode, pay particular attention to the tool path when automatic operation is subsequently resumed. Refer to the descriptions of the corresponding functions for details.

13. Program editing

If the machine is stopped, after which the machining program is edited (modification, insertion, or deletion), the machine may behave unexpectedly if machining is resumed under the control of that program. Basically, do not modify, insert, or delete commands from a machining program while it is in use.

5

WARNINGS RELATED TO DAILY MAINTENANCE

WARNING

1. Memory backup battery replacement

When replacing the memory backup batteries, keep the power to the machine (CNC) turned on, and apply an emergency stop to the machine. Because this work is performed with the power on and the cabinet open, only those personnel who have received approved safety and maintenance training may perform this work.

When replacing the batteries, be careful not to touch the high-voltage circuits (marked  and fitted with an insulating cover).

Touching the uncovered high-voltage circuits presents an extremely dangerous electric shock hazard.

NOTE

The CNC uses batteries to preserve the contents of its memory, because it must retain data such as programs, offsets, and parameters even while external power is not applied.

If the battery voltage drops, a low battery voltage alarm is displayed on the machine operator's panel or screen.

When a low battery voltage alarm is displayed, replace the batteries within a week. Otherwise, the contents of the CNC's memory will be lost.

Refer to the maintenance section of the operator's manual or programming manual for details of the battery replacement procedure.

WARNING**2. Absolute pulse coder battery replacement**

When replacing the memory backup batteries, keep the power to the machine (CNC) turned on, and apply an emergency stop to the machine. Because this work is performed with the power on and the cabinet open, only those personnel who have received approved safety and maintenance training may perform this work.

When replacing the batteries, be careful not to touch the high-voltage circuits (marked  and fitted with an insulating cover).

Touching the uncovered high-voltage circuits presents an extremely dangerous electric shock hazard.

NOTE

The absolute pulse coder uses batteries to preserve its absolute position.

If the battery voltage drops, a low battery voltage alarm is displayed on the machine operator's panel or screen.

When a low battery voltage alarm is displayed, replace the batteries within a week. Otherwise, the absolute position data held by the pulse coder will be lost.

Refer to FANUC SERVO AMPLIFIER αi series MAINTENANCE MANUAL and FANUC SERVO AMPLIFIER βi series MAINTENANCE MANUAL for details of the battery replacement procedure.

WARNING**3. Fuse replacement**

For some units, the chapter covering daily maintenance in the operator's manual or programming manual describes the fuse replacement procedure.

Before replacing a blown fuse, however, it is necessary to locate and remove the cause of the blown fuse.

For this reason, only those personnel who have received approved safety and maintenance training may perform this work.

When replacing a fuse with the cabinet open, be careful not to touch the high-voltage circuits (marked  and fitted with an insulating cover).

Touching an uncovered high-voltage circuit presents an extremely dangerous electric shock hazard.

Table of Contents

SAFETY PRECAUTIONS	s-1
I. GENERAL	
1. GENERAL	3
2. LIST OF SPECIFICATIONS	8
II. NC FUNCTION	
PREFACE	33
1. CONTROLLED AXES	34
1.1 NUMBER OF THE ALL CONTROLLED AXES	35
1.2 MACHINE CONTROLLED AXES	36
1.2.1 Number of Controlled Paths	36
1.2.2 Number of Basic Controlled Axes	36
1.2.3 Number of Basic Simultaneously Controlled Axes	36
1.2.4 Number of Controlled Axes Expanded (All)	36
1.2.5 Number of Simultaneously Controlled Axes Expanded (All)	37
1.2.6 Axis Control by PMC	37
1.2.7 Cs Contour Control	37
1.3 LOADER CONTROLLED AXES	38
1.4 AXIS NAMES	38
1.5 INCREMENT SYSTEM	39
1.5.1 Input Unit (10 Times)	40
1.6 MAXIMUM STROKE	41
2. PREPARATORY FUNCTIONS	42
2.1 T SERIES	43
2.2 M SERIES	46
3. INTERPOLATION FUNCTIONS	50
3.1 POSITIONING (G00)	51
3.2 SINGLE DIRECTION POSITIONING (G60) (M series)	52
3.3 LINEAR INTERPOLATION (G01)	53
3.4 CIRCULAR INTERPOLATION (G02, G03)	54
3.5 HELICAL INTERPOLATION (G02, G03)	56
3.6 HELICAL INTERPOLATION B (G02, G03) (M series)	57
3.7 POLAR COORDINATE INTERPOLATION (G12.1, G13.1)	58
3.8 CYLINDRICAL INTERPOLATION (G07.1)	60
3.9 CYLINDRICAL INTERPOLATION CUTTING POINT COMPENSATION (G07.1) (M series) ..	62
3.10 INVOLUTE INTERPOLATION (G02.2, G03.2) (M series)	65
3.10.1 Involute Interpolation Automatic Feedrate Control Function (M series)	66
3.11 EXPONENTIAL FUNCTION INTERPOLATION (G02.3, G03.3) (M series)	67
3.12 SMOOTH INTERPOLATION (G05.1) (ONLY AT 1-PATH CONTROL) (M series)	69
3.13 HYPOTHETICAL AXIS INTERPOLATION (G07)	70

3.14	SPIRAL INTERPOLATION, CONICAL INTERPOLATION (M series)	71
3.15	NURBS INTERPOLATION (G06.2)	73
3.16	3-DIMENSIONAL CIRCULAR INTERPOLATION (G02.4 AND G03.4)	75
4.	THREAD CUTTING	76
4.1	EQUAL LEAD THREAD CUTTING (G33) (WITH G CODE SYSTEM A: G32)	77
4.2	MULTIPLE-THREAD CUTTING (G33) (T series)	78
4.3	VARIABLE LEAD THREAD CUTTING (G34) (T series)	78
4.4	CONTINUOUS THREAD CUTTING (T series)	79
4.5	CIRCULAR THREADING (G35, G36) (T series)	79
5.	FEED FUNCTIONS	80
5.1	RAPID TRAVERSE	81
5.2	CUTTING FEED RATE	82
5.2.1	Tangential Speed Constant Control	82
5.2.2	Cutting Feed Rate Clamp	82
5.2.3	Per Minute Feed (G94) (G98 for G-code System A)	82
5.2.4	Per Revolution Feed (G95) (G99 for G-code System A)	83
5.2.5	Inverse Time Feed (G93) (M series)	83
5.2.6	One-digit F Code Feed (M series)	83
5.3	OVERRIDE	84
5.3.1	Feed Rate Override	84
5.3.2	Second Feed Rate Override	84
5.3.3	Rapid Traverse Override	84
5.3.4	Override Cancel	84
5.3.5	Jog Override	84
5.4	AUTOMATIC ACCELERATION/DECELERATION	85
5.5	RAPID TRAVERSE BELL-SHAPED ACCELERATION/DECELERATION	86
5.6	LINEAR ACCELERATION/DECELERATION AFTER CUTTING FEED INTERPOLATION ..	87
5.7	BELL-SHAPED ACCELERATION/DECELERATION AFTER CUTTING FEED INTERPOLATION	88
5.8	LINEAR ACCELERATION/DECELERATION BEFORE CUTTING FEED INTERPOLATION	89
5.9	ERROR DETECTION (T series)	90
5.10	EXACT STOP (G09) (M series)	91
5.11	EXACT STOP MODE (G61) (M series)	91
5.12	CUTTING MODE (G64) (M series)	91
5.13	TAPPING MODE (G63) (M series)	91
5.14	AUTOMATIC CORNER OVERRIDE (G62) (M series)	91
5.15	DWELL (G04)	92
5.16	POSITIONING BY OPTIMUM ACCELERATION	92
5.17	RAPID TRAVERSE BLOCK OVERLAP	93
6.	REFERENCE POSITION	94
6.1	MANUAL REFERENCE POSITION RETURN	95
6.2	SETTING THE REFERENCE POSITION WITHOUT DOGS	95
6.3	AUTOMATIC REFERENCE POSITION RETURN (G28, G29) (M series)	96

6.4	REFERENCE POSITION RETURN CHECK (G27)	97
6.5	2ND, 3RD AND 4TH REFERENCE POSITION RETURN (G30)	97
6.6	FLOATING REFERENCE POSITION RETURN (G30.1)	98
6.7	REFERENCE POSITION SHIFT	99
6.8	BUTT-TYPE REFERENCE POSITION SETTING	99
6.9	LINEAR SCALE WITH ABSOLUTE ADDRESSING REFERENCE MARKS	100
6.10	LINEAR SCALE EXPANSION FUNCTION WITH ABSOLUTE ADDRESSING REFERENCE MARKS	100
6.11	LINEAR INTERPOLATION G28, G30, AND G53	100
7.	COORDINATE SYSTEMS	101
7.1	MACHINE COORDINATE SYSTEM (G53)	102
7.2	WORKPIECE COORDINATE SYSTEM	103
7.2.1	Setting a Workpiece Coordinate System (Using G92) (with G Code System A: G50)	103
7.2.2	Automatic Coordinate System Setting	105
7.2.3	Setting a Workpiece Coordinate System (Using G54 to G59)	106
7.2.4	Counter Input in a Workpiece Coordinate System	107
7.3	LOCAL COORDINATE SYSTEM (G52)	108
7.4	WORKPIECE ORIGIN OFFSET VALUE CHANGE (PROGRAMMABLE DATA INPUT) (G10)	109
7.5	ADDITIONAL WORKPIECE COORDINATE SYSTEMS (M series)	110
7.6	WORKPIECE COORDINATE SYSTEM PRESET (G92.1)	111
7.7	WORKPIECE COORDINATE SYSTEM SHIFT (T series)	112
7.8	PLANE SELECTION (G17, G18, G19)	113
8.	COORDINATE VALUE AND DIMENSION	114
8.1	ABSOLUTE AND INCREMENTAL PROGRAMMING (G90, G91)	115
8.2	POLAR COORDINATE COMMAND (G15, G16) (M series)	116
8.3	INCH/METRIC CONVERSION (G20, G21)	117
8.4	DECIMAL POINT INPUT/POCKET CALCULATOR TYPE DECIMAL POINT INPUT	117
8.5	DIAMETER AND RADIUS PROGRAMMING (T series)	117
8.6	LINEAR AXIS AND ROTATION AXIS	118
8.7	ROTATION AXIS ROLL-OVER FUNCTION	118
8.8	ROTARY AXIS CONTROL	118
9.	SPINDLE FUNCTIONS	119
9.1	S CODE OUTPUT	120
9.2	SPINDLE SPEED ANALOG OUTPUT (S ANALOG OUTPUT)	120
9.3	SPINDLE SPEED SERIAL OUTPUT (S SERIAL OUTPUT)	120
9.4	SPINDLE OUTPUT CONTROL BY THE PMC	120
9.5	CONSTANT SURFACE SPEED CONTROL	121
9.6	SPINDLE OVERRIDE	121
9.7	ACTUAL SPINDLE SPEED OUTPUT (T series)	121
9.8	SPINDLE POSITIONING (T series)	122
9.9	SPINDLE SPEED FLUCTUATION DETECTION (G25, G26)	123
9.10	Cs CONTOUR CONTROL	125

9.11	MULTI-SPINDLE CONTROL	126
9.12	SPINDLE SYNCHRONIZATION CONTROL	127
9.13	SPINDLE ORIENTATION	127
9.14	SPINDLE OUTPUT SWITCHING	127
9.15	THREE/FOUR -SPINDLE SERIAL OUTPUT	127
9.16	SIMPLE SPINDLE SYNCHRONOUS CONTROL	127
9.17	SERIAL SPINDLE ADVANCED CONTROL	128
9.18	SPINDLE POSITION DATA DISPLAY	128
10.	TOOL FUNCTIONS	129
10.1	T CODE OUTPUT	130
10.2	TOOL LIFE MANAGEMENT	131
10.2.1	Tool Life Management	131
10.2.2	Addition of Tool Pairs for Tool Life Management <512 Pairs (M series) / 128 Pairs (T series)>	132
10.2.3	Extended Tool Life Management (M series)	132
10.3	TOOL LIFE MANAGEMENT B (M series)	133
11.	MISCELLANEOUS FUNCTIONS	134
11.1	MISCELLANEOUS FUNCTIONS	135
11.2	1-BLOCK PLURAL M COMMAND	135
11.3	SECOND MISCELLANEOUS FUNCTIONS	135
11.4	HIGH-SPEED M/S/T/B INTERFACE	136
11.5	M CODE GROUP CHECK FUNCTION	137
12.	PROGRAM CONFIGURATION	138
12.1	PROGRAM NUMBER	139
12.2	PROGRAM NAME	139
12.3	MAIN PROGRAM	139
12.4	SUB PROGRAM	140
12.5	EXTERNAL MEMORY AND SUB PROGRAM CALLING FUNCTION	141
12.6	SEQUENCE NUMBER	141
12.7	TAPE CODES	141
12.8	BASIC ADDRESSES AND COMMAND VALUE RANGE	142
12.9	TAPE FORMAT	144
12.10	LABEL SKIP	144
12.11	CONTROL-IN/CONTROL-OUT	144
12.12	OPTIONAL BLOCK SKIP	144
12.13	ADDITIONAL OPTIONAL BLOCK SKIP	144
12.14	TAPE HORIZONTAL (TH) PARITY CHECK AND TAPE VERTICAL (TV) PARITY CHECK	144
13.	FUNCTIONS TO SIMPLIFY PROGRAMMING	145
13.1	CANNED CYCLES (G73, G74, G76, G80-G89, G98, G99) (M series)	146
13.2	RIGID TAPPING	152
13.2.1	Rigid Tapping	152
13.2.2	Rigid Tapping Bell-shaped Acceleration/Deceleration (M series)	156

13.2.3	Three-dimensional Rigid Tapping	157
13.2.4	Other Rigid Tapping Functions (M series)	157
13.3	EXTERNAL OPERATION FUNCTION (G81) (M series)	158
13.4	CANNED CYCLES FOR TURNING (T series)	159
13.4.1	Cutting Cycle A (G77) (with G Code System A: G90)	159
13.4.2	Thread Cutting Cycle (G78) (with G Code System A: G92)	160
13.4.3	Turning Cycle in Facing (G79) (with G Code System A: G94)	162
13.5	MULTIPLE REPETITIVE CYCLES FOR TURNING (G70 - G76) (T series)	163
13.5.1	Stock Removal in Turning (G71)	163
13.5.2	Stock Removal in Facing (G72)	167
13.5.3	Pattern Repeating (G73)	168
13.5.4	Finishing Cycle (G70)	169
13.5.5	Peck Drilling in Z-axis (G74)	170
13.5.6	Grooving in X-axis (G75)	171
13.5.7	Thread Cutting Cycle (G76)	172
13.6	CANNED CYCLES FOR DRILLING (G80 - G89) (T series)	174
13.7	CHAMFERING AND CORNER R (T series)	175
13.8	OPTIONAL ANGLE CHAMFERING/CORNER ROUNDING (M series)	177
13.9	DIRECT DRAWING DIMENSIONS PROGRAMMING (T series)	178
13.10	PROGRAMMABLE MIRROR IMAGE (G50.1, G51.1) (M series)	180
13.11	MIRROR IMAGE FOR DOUBLE TURRETS (G68, G69) (T series)	181
13.12	INDEX TABLE INDEXING (M series)	182
13.13	CANNED CYCLES FOR CYLINDRICAL GRINDING (T series)	183
13.13.1	Traverse Grinding Cycle (G71)	184
13.13.2	Traverse Direct Gauge Grinding Cycle (G72)	184
13.13.3	Oscillation Grinding Cycle (G73)	185
13.13.4	Oscillation Direct Gauge Grinding Cycle (G74)	185
13.14	SURFACE GRINDING CANNED CYCLE (M series)	186
13.14.1	Plunge Grinding Cycle (G75)	187
13.14.2	Plunge Direct Grinding Cycle (G77)	189
13.14.3	Continuous Feed Plane Grinding Cycle (G78)	190
13.14.4	Intermittent Feed Plane Grinding Cycle (G79)	192
13.15	INFEED CONTROL (M series)	194
13.16	FIGURE COPYING (G72.1, G72.2) (M series)	195
13.16.1	Rotation Copy (G72.1)	196
13.16.2	Linear Copy (G72.2)	197
14.	TOOL COMPENSATION FUNCTION	198
14.1	TOOL OFFSET (T series)	199
14.1.1	Tool Offset (T Code)	199
14.1.2	Tool Geometry Compensation and Tool Wear Compensation	200
14.1.3	Y Axis Offset	200
14.2	TOOL NOSE RADIUS COMPENSATION (G40, G41, G42) (T series)	201
14.3	CORNER CIRCULAR INTERPOLATION FUNCTION (G39) (T series)	203
14.4	TOOL LENGTH COMPENSATION (G43, G44, G49) (M series)	204
14.5	TOOL OFFSET (G45, G46, G47, G48) (M series)	205
14.6	CUTTER COMPENSATION (M series)	206
14.6.1	Cutter Compensation B (G40 - 42)	206
14.6.2	Cutter Compensation C (G40 - G42)	206
14.7	CORNER CIRCULAR INTERPOLATION FUNCTION (G39) (M series)	208

14.8	TOOL COMPENSATION MEMORY	209
14.8.1	Tool Compensation Memory (M series)	209
14.8.2	Tool Offset Amount Memory (T series)	210
14.9	NUMBER OF TOOL OFFSETS	212
14.9.1	Number of Tool Offsets (M series)	212
14.9.2	Number of Tool Offsets (T series)	212
14.10	CHANGING OF TOOL OFFSET AMOUNT (PROGRAMMABLE DATA INPUT) (G10)	213
14.11	GRINDING-WHEEL WEAR COMPENSATION BY CONTINUOUS DRESSING (M series) ...	215
14.12	THREE-DIMENSIONAL TOOL COMPENSATION (G40, G41) (M series)	216
14.13	GRINDING WHEEL WEAR COMPENSATION (G40, G41) (M series)	217
14.14	TOOL AXIS DIRECTION TOOL LENGTH COMPENSATION	218
14.15	THREE-DIMENSIONAL CUTTER COMPENSATION	221
14.15.1	Tool Side Compensation	221
14.15.2	Leading Edge Offset	222
14.16	TOOL CENTER POINT CONTROL	223
14.17	ROTARY TABLE DYNAMIC FIXTURE OFFSET	224
15.	ACCURACY COMPENSATION FUNCTION	225
15.1	STORED PITCH ERROR COMPENSATION	226
15.2	BI-DIRECTIONAL PITCH ERROR COMPENSATION	226
15.3	INTERPOLATION TYPE PITCH ERROR COMPENSATION	227
15.4	INCLINATION COMPENSATION	228
15.5	STRAIGHTNESS COMPENSATION	228
15.6	ADIFFERENCE AMONG PITCH ERROR COMPENSATION, INCLINATION COMPENSATION, AND STRAIGHTNESS COMPENSATION	231
15.7	BACKLASH COMPENSATION	233
15.8	BACKLASH COMPENSATION SPECIFIC TO RAPID TRAVERSE AND CUTTING FEED ...	233
15.9	PROGRAMMABLE PARAMETER ENTRY (G10, G11)	234
15.10	INTERPOLATED STRAIGHTNESS COMPENSATION	235
16.	COORDINATE SYSTEM CONVERSION	236
16.1	COORDINATE SYSTEM ROTATION (G68, G69) – (M SERIES) (G68.1, G69.1) – (T SERIES)	237
16.2	SCALING (G50, G51) (M series)	239
16.3	THREE-DIMENSIONAL COORDINATE CONVERSION (G68, G69) (M series)	241
17.	MEASUREMENT FUNCTIONS	242
17.1	SKIP FUNCTION (G31)	243
17.2	MULTI-STEP SKIP FUNCTION (G31 P1 - G31 P4)	244
17.3	HIGH-SPEED SKIP SIGNAL INPUT	244
17.4	TORQUE LIMIT SKIP (G31 P99, G31 P98)	244
17.5	CONTINUOUS HIGH-SPEED SKIP FUNCTION (G31, P90) (M series)	244
17.6	TOOL LENGTH AUTOMATIC MEASUREMENT (G37) (M series)	245
17.7	AUTOMATIC TOOL OFFSET (G37, G36) (T series)	246
17.8	TOOL LENGTH MEASUREMENT (M series)	247

17.9	DIRECT INPUT OF TOOL COMPENSATION MEASURED VALUE/DIRECT INPUT OF WORKPIECE COORDINATE SYSTEM SHIFT AMOUNT (T series)	248
17.10	TOOL COMPENSATION VALUE MEASURED VALUE DIRECT INPUT B (T series)	249
17.11	COUNT INPUT OF TOOL OFFSET VALUES (T series)	253
17.12	DIRECT INPUT OF WORKPIECE ZERO POINT OFFSET VALUE MEASURED	253
17.13	TOOL LENGTH/WORKPIECE ORIGIN MEASUREMENT B (M series)	253
18.	CUSTOM MACRO	254
18.1	CUSTOM MACRO	255
18.2	INCREASED CUSTOM MACRO COMMON VARIABLES	261
18.3	INTERRUPTION TYPE CUSTOM MACRO	261
18.4	PATTERN DATA INPUT	262
18.5	MACRO EXECUTER FUNCTION	263
18.6	C LANGUAGE EXECUTER FUNCTION	264
18.7	EMBEDDED MACROS	265
18.8	EMBEDDED MILLING MACRO (M series)	267
18.9	MEASUREMENT CYCLE (M series)	267
19.	SERIES 15 TAPE FORMAT/SERIES 10/11 TAPE FORMAT	268
19.1	SERIES 15 TAPE FORMAT	269
19.2	SERIES-10/11 TAPE FORMAT	269
20.	FUNCTIONS FOR HIGH SPEED CUTTIN	270
20.1	HIGH-SPEED CYCLE MACHINING (ONLY AT 1-PATH CONTROL)	271
20.1.1	High-speed Cycle Machining (only at one-path)	271
20.1.2	High-Speed Cycle Machining Skip Function	272
20.2	AUTOMATIC CORNER DECELERATION	273
20.3	FEEDRATE CLAMP BY CIRCULAR RADIUS (M SERIES)	274
20.4	ADVANCED PREVIEW CONTROL (G08)	275
20.5	REMOTE BUFFER	276
20.5.1	Remote Buffer (Only at 1-path Control)	276
20.5.2	High-speed Remote Buffer A (G05) (Only at 1-path Control)	278
20.5.3	High-speed Remote Buffer B (G05) (Only at 1-path Control) (M series)	279
20.6	HIGH-PRECISION CONTOUR CONTROL (ONLY AT ONE-PATH CONTROL) (M series)	280
20.6.1	Acceleration/DecelerationBefore Interpolation by Pre-reading Multiple Blocks	280
20.6.2	Automatic Velocity Control Function	281
20.7	AI CONTOUR CONTROL (G05.1) (M series)	282
20.8	HIGH-SPEED LINEAR INTERPOLATION (G05) (M series)	282
20.9	AI HIGH-PRECISION CONTOUR CONTROL/AI NANO HIGH-PRECISION CONTOUR CONTROL (M series)	283
20.10	AI NANO CONTOUR CONTROL (G05.1) (M series)	285
20.11	AI ADVANCED PREVIEW CONTROL (FOR THE 21i-M ONLY) (G05.1) (M series)	285
20.12	LOOK-AHEAD BELL-SHAPED ACCELERATION/DECELERATION BEFORE INTERPOLATION TIME CONSTANT CHANGE FUNCTION (M Series)	286
20.13	OPTIMUM TORQUE ACCELERATION/DECELERATION (M series)	288

21.AXES CONTROL	289
21.1 FOLLOW UP FUNCTION	290
21.2 MECHANICAL HANDLE FEED	290
21.3 SERVO OFF	290
21.4 MIRROR IMAGE	290
21.5 CONTROL AXIS DETACH	290
21.6 SIMPLE SYNCHRONOUS CONTROL	291
21.7 SYNCHRONIZATION CONTROL (ONLY AT 1-PATH CONTROL) (T series)	292
21.8 FEED STOP	293
21.9 NORMAL DIRECTION CONTROL (G40.1,G41.1,G42.1) (M series)	294
21.10 POLYGONAL TURNING (G50.2, G51.2) (T series)	296
21.11 POLYGONAL TURNING WITH TWO SPINDLES (T series)	298
21.12 AXIS CONTROL WITH PMC	298
21.13 ANGULAR AXIS CONTROL	299
21.14 ARBITRARY ANGULAR AXIS CONTROL	299
21.15 B-AXIS CONTROL (T series)	299
21.16 TANDEM CONTROL	300
21.17 CHOPPING FUNCTION (G80, G81.1) (M series)	301
21.18 HOB	302
21.18.1 Hobbing Machine Function (G80, G81) (M series)	302
21.18.2 Hobbing Function (G80.4, G81.4) (T series)	303
21.19 SIMPLE ELECTRIC GEAR BOX (G80, G81) (M series)	304
21.20 SKIP FUNCTION FOR EGB AXIS (M series)	305
21.21 ELECTRIC GEAR BOX TWO PAIR (M series)	306
21.22 ELECTRIC GEAR BOX AUTOMATIC PHASE SYNCHRONIZATION (M series)	308
21.22.1 Acceleration/DecelerationType	308
21.22.2 Acceleration/Deceleration and Automatic Phase Synchronization	309
21.23 SPINDLE ELECTRIC GEAR BOX (M series)	310
21.24 FLEXIBLE SYNCHRONIZATION CONTROL FUNCTION (M series)	312
21.25 TEMPORARY ABSOLUTE COORDINATE SETTING	313
21.26 GENERAL-PURPOSE RETRACTION	314
22.FUNCTIONS SPECIFIC TO 2-PATH CONTROL	315
22.1 WAITING FUNCTION	318
22.2 TOOL POST INTERFERENCE CHECK (T series)	319
22.3 BALANCE CUT (G68, G69) (T series)	320
22.4 MEMORY COMMON TO PATHS	320
22.5 AXIS RECOMPOSITION (T series)	321
22.6 COPYING A PROGRAM BETWEEN TWO PATHS	323
23.MANUAL OPERATION	324
23.1 JOG FEED	325
23.2 INCREMENTAL FEED	325
23.3 MANUAL HANDLE FEED (1ST)	325
23.4 MANUAL HANDLE FEED (2ND, 3RD) (T SERIES: 2ND)	325

23.5	HANDLE FEED IN THE SAME MODE AS FOR JOG FEED	326
23.6	MANUAL PER-ROTATION FEED (T series)	326
23.7	MANUAL ABSOLUTE ON/OFF	326
23.8	TOOL AXIS DIRECTION HANDLE FEED AND TOOL AXIS DIRECTION HANDLE FEED B (M series)	327
23.8.1	Tool Axis Direction Handle Feed	327
23.8.2	Tool Axis Normal Direction Handle Feed	327
23.9	MANUAL LINEAR/CIRCULAR INTERPOLATION (ONLY AT 1-PATH CONTROL)	328
23.10	RIGID TAPPING BY MANUAL HANDLE FEED (M series)	328
23.11	MANUAL NUMERIC COMMAND	329
23.12	THE STOP POSITION SETTING WITH THE MANUAL FEED (T series)	329
24.	AUTOMATIC OPERATION	330
24.1	OPERATION MODE	331
24.1.1	DNC Operation	331
24.1.2	Memory Operation	331
24.1.3	MDI Operation	331
24.2	SELECTION OF EXECUTION PROGRAMS	332
24.2.1	Program Number Search	332
24.2.2	Sequence Number Search	332
24.2.3	Rewind	332
24.2.4	External Workpiece Number Search	332
24.2.5	Expanded External Workpiece Number Search	332
24.3	ACTIVATION OF AUTOMATIC OPERATION	333
24.3.1	Cycle Start	333
24.4	EXECUTION OF AUTOMATIC OPERATION	333
24.4.1	Buffer Register	333
24.5	AUTOMATIC OPERATION STOP	334
24.5.1	Program Stop (M00, M01)	334
24.5.2	Program End (M02, M30)	334
24.5.3	Sequence Number Comparison and Stop	334
24.5.4	Feed Hold	334
24.5.5	Thread Cutting Cycle Retract (T series)	334
24.5.6	Reset	334
24.6	RESTART OF AUTOMATIC OPERATION	335
24.6.1	Program Restart	335
24.6.2	Tool Retract & Recover	335
24.6.3	Manual Intervention and Return	336
24.7	MANUAL INTERRUPTION DURING AUTOMATIC OPERATION	337
24.7.1	Manual Handle Interruption	337
24.8	SCHEDULING FUNCTION	338
24.9	SIMULTANEOUS INPUT AND OUTPUT OPERATIONS (ONLY AT 1-PATH CONTROL) (M series)	339
24.10	RETRACE FUNCTION (M series)	339
24.11	RIGID TAPPING RETURN (M series)	340
24.11.1	Rigid Tapping Return by Specifying G30	340
25.	PROGRAM TEST FUNCTIONS	341
25.1	ALL-AXES MACHINE LOCK	342
25.2	MACHINE LOCK ON EACH AXIS	342

25.3	AUXILIARY FUNCTION LOCK	342
25.4	DRY RUN	342
25.5	SINGLE BLOCK	342
25.6	MANUAL HANDLE RETRACE (T series)	343
26.	SETTING AND DISPLAY UNIT	344
26.1	SETTING AND DISPLAY UNIT	345
26.1.1	7.2"/8.4" LCD-mounted Type CNC Control Unit	345
26.1.2	9.5"/10.4" LCD-mounted Type CNC Control Unit	346
26.1.3	Stand-alone Type Small MDI Unit	347
26.1.4	Stand-alone Type Standard MDI Unit (Horizontal Type)	348
26.1.5	Stand-alone Type Standard MDI Unit (Vertical Type)	349
26.2	EXPLANATION OF THE KEYBOARD	350
26.2.1	Explanation of the Function Keys	351
26.2.2	Explanation of the Soft Keys	352
27.	DISPLAYING AND SETTING DATA	353
27.1	DISPLAY	354
27.2	LANGUAGE SELECTION	357
27.3	CLOCK FUNCTION	357
27.4	RUN TIME & PARTS NUMBER DISPLAY	357
27.5	SOFTWARE OPERATOR'S PANEL	358
27.6	DIRECTORY DISPLAY OF FLOPPY CASSETTE	360
27.7	GRAPHIC DISPLAY FUNCTION	361
27.7.1	Graphic Display Function	361
27.7.2	Dynamic Graphic Display	362
27.7.3	Background Drawing (M series)	367
27.8	SERVO WAVEFORM FUNCTION	368
27.9	SCREENS FOR SERVO DATA AND SPINDLE DATA	369
27.9.1	Servo Setting Screen	369
27.9.2	Servo Adjustment Screen	369
27.9.3	Spindle Setting Screen	370
27.9.4	Spindle Adjustment Screen	370
27.9.5	Spindle Monitor Screen	371
27.10	SYSTEM CONFIGURATION DISPLAY FUNCTION	372
27.11	HELP FUNCTION	374
27.12	DATA PROTECTION KEY	376
27.13	DISPLAYING OPERATION HISTORY	376
27.14	MACHINING TIME STAMP FUNCTION	376
27.15	REMOTE DIAGNOSIS	377
27.16	DIRECTORY DISPLAY AND PUNCH FOR A SPECIFIED GROUP	379
27.17	CLEARING THE SCREEN	379
27.18	PERIODIC MAINTENANCE SCREEN	380
27.19	TOUCH PANEL	380
27.20	EXTERNAL TOUCH PANEL INTERFACE	380
27.21	MAINTENANCE INFORMATION SCREEN	381
27.22	COLOR SETTING SCREEN	381

27.23	CONTRAST ADJUSTMENT SCREEN	382
27.24	SETTING THE EMBEDDED ETHERNET FUNCTION	383
27.24.1	FACTOLINK Parameter Setting Screen	383
27.24.2	FOCAS1/Ethernet Parameter Setting Screen	386
27.24.3	FTP File Transfer Parameter Setting Screen	390
27.25	ID INFORMATION SCREEN	394
27.25.1	<i>αi</i> Servo Information Screen	394
27.25.2	<i>αi</i> Spindle Information Screen	395
28.	PART PROGRAM STORAGE AND EDITING	396
28.1	BACKGROUND EDITING	397
28.2	BACKGROUND EDITING	397
28.3	EXPANDED PART PROGRAM EDITING	398
28.4	NUMBER OF REGISTERED PROGRAMS	398
28.5	PART PROGRAM STORAGE LENGTH	398
28.6	PLAY BACK	398
28.7	EXTERNAL CONTROL OF I/O DEVICE	398
28.8	CONVERSATIONAL PROGRAMMING OF FIGURES (ONLY AT 1-PATH CONTROL)	399
28.9	PASSWORD FUNCTION	399
29.	DIAGNOSIS FUNCTIONS	400
29.1	SELF DIAGNOSIS FUNCTIONS	401
30.	DATA INPUT/OUTPUT	402
30.1	READER/PUNCH INTERFACES	403
30.2	INPUT/OUTPUT DEVICES	404
30.2.1	FANUC Floppy Cassette	404
30.2.2	FANUC Program File Mate	404
30.2.3	FANUC Handy File	404
30.3	EXTERNAL PROGRAM INPUT	404
30.4	DATA INPUT/OUTPUT USING A MEMORY CARD	405
30.5	SCREEN HARD COPY	406
30.6	DNC1 CONTROL	407
30.7	DNC2 CONTROL (ONLY AT 1-PATH CONTROL)	408
30.8	ETHERNET FUNCTION (OPTION BOARD)	409
30.8.1	FOCAS1/Ethernet Function	410
30.8.2	DNC1/Ethernet Function	411
30.8.3	FACTOLINK Function	412
30.8.4	Data Server Function	413
30.9	EMBEDDED ETHERNET FUNCTION	415
30.9.1	Embedded Ethernet and PCMCIA Ethernet	415
30.9.2	List of Functions	416
30.9.2.1	FACTOLINK function	416
30.9.2.2	FOCAS1/Ethernet function	417
30.9.2.3	DNC1/Ethernet function	418
30.9.2.4	FTP file transfer function	420
30.9.2.5	Functional differences between the embedded Ethernet function and the Ethernet function based on the option board	420

30.10	DATA INPUT/OUTPUT FUNCTION BASED ON THE I/O LINK AND DATA INPUT/OUTPUT FUNCTION B BASED ON THE I/O LINK	422
30.11	POWER MATE CNC MANAGER	423
30.12	FIELD NETWORKS	424
31.	SAFETY FUNCTIONS	425
31.1	EMERGENCY STOP	426
31.2	OVERTRAVEL FUNCTIONS	428
31.2.1	Overtravel	428
31.2.2	Stored Stroke Check 1	428
31.2.3	Stored Stroke Check 2 (G22, G23) (M series)	429
31.2.4	Stored Stroke Checks 3 (M series)	429
31.2.5	Stored Stroke Checks 2 and 3 (G22, G23) (T series)	430
31.2.6	Stroke Limit Check Before Movement	431
31.2.7	Externally Setting the Stroke Limit	432
31.2.8	Chuck/Tail Stock Barrier (T series)	433
31.2.9	Rotation Area Interference Check	435
31.3	INTERLOCK	436
31.3.1	Interlock per Axis	436
31.3.2	All Axes Interlock	436
31.3.3	Interlock for Each Axis Direction	436
31.3.4	Start Lock	436
31.3.5	Block Start Interlock	436
31.3.6	Cutting Block Start Interlock	436
31.4	EXTERNAL DECELERATION	437
31.5	ABNORMAL LOAD DETECTION	437
31.6	FINE TORQUE SENSING	437
31.7	SERVO/SPINDLE MOTOR SPEED DETECTION	438
32.	STATUS OUTPUT	439
32.1	NC READY SIGNAL	440
32.2	SERVO READY SIGNAL	440
32.3	REWINDING SIGNAL	440
32.4	ALARM SIGNAL	440
32.5	DISTRIBUTION END SIGNAL	440
32.6	AUTOMATIC OPERATION SIGNAL	440
32.7	AUTOMATIC OPERATION START SIGNAL	440
32.8	FEED HOLD SIGNAL	440
32.9	RESET SIGNAL	440
32.10	IN-POSITION SIGNAL	440
32.11	MOVE SIGNAL	440
32.12	AXIS MOVE DIRECTION SIGNAL	441
32.13	RAPID TRAVERSING SIGNAL	441
32.14	TAPPING SIGNAL	441
32.15	THREAD CUTTING SIGNAL	441
32.16	CONSTANT SURFACE SPEED CONTROL SIGNAL	441
32.17	INCH INPUT SIGNAL	441
32.18	DI STATUS OUTPUT SIGNAL	441

32.19	POSITION SWITCH FUNCTION	441
32.20	HIGH-SPEED POSITION SWITCH	442
32.21	DIRECTION DECISION TYPE HIGH-SPEED POSITION SWITCH	442
33.	EXTERNAL DATA INPUT	443
33.1	EXTERNAL TOOL COMPENSATION	444
33.2	EXTERNAL PROGRAM NUMBER SEARCH	444
33.3	ONE-TOUCH MACRO CALL	444
33.4	EXTERNAL WORKPIECE COORDINATE SYSTEM SHIFT	444
33.5	EXTERNAL MACHINE ZERO POINT SHIFT	444
33.6	EXTERNAL ALARM MESSAGE	445
33.7	EXTERNAL OPERATOR'S MESSAGE	445
33.8	SUBSTITUTION OF THE NUMBER OF REQUIRED PARTS AND NUMBER OF MACHINED PARTS	445
34.	KEY INPUT FROM PMC (EXTERNAL KEY INPUT)	446
35.	PERSONAL COMPUTER FUNCTION	447
35.1	160i/180i/210i	448
35.2	160iS/180iS/210iS	450
35.3	HIGH-SPEED SERIAL BUS (HSSB)	453
35.4	SYSTEM IN WHICH A COMMERCIALY AVAILABLE PERSONAL COMPUTER AND THE CNC ARE CONNECTED VIA THE HIGH-SPEED SERIAL BUS	454
36.	INTERFACE WITH THE POWER MATE CNC	455
36.1	FANUC SERVO MOTOR β SERIES I/O LINK OPTION MANUAL HANDLE INTERFACE (PERIPHERAL EQUIPMENT CONTROL)	456
III. AUTOMATIC PROGRAMMING FUNCTION		
1.	OUTLINE OF CONVERSATIONAL AUTOMATIC PROGRAMMING	459
2.	CONVERSATIONAL AUTOMATIC PROGRAMMING FUNCTION FOR LATHES	460
2.1	SYMBOL CAPI T	461
2.1.1	Features	461
2.1.2	Applicable Machines	461
2.1.3	Outline of the Conversational Automatic Programming Function	462
2.2	SUPER CAPI T	468
2.2.1	Features	468
2.2.2	Applicable Machines	468
2.2.3	Outline of the Conversational Automatic Programming Function	469
2.3	MANUAL GUIDE	475
2.3.1	Features	475
2.3.2	Supported Machine Tools	477
2.3.3	Operation	478
2.3.4	Display Screen	479

3. CONVERSATIONAL AUTOMATIC PROGRAMMING FUNCTION FOR MACHINING CENTERS	482
3.1 SUPER CAPi M	483
3.1.1 Features	483
3.1.2 Outline of the Macro Library	483
3.1.3 Outline of the Conversational Automatic Programming Function	485
3.1.4 Other Optional Functions	488
3.2 MANUAL GUIDE	491
3.2.1 Features	491
3.2.2 Operation	492
3.2.3 Display Screen	493

IV. HAND CNC (Series 20i)

1. OUTLINE OF HAND CNC (SERIES 20i)	499
2. LIST OF SPECIFICATIONS	500
3. MACHINING GUIDANCE FUNCTION	512
4. GUIDANCE PROGRAMMING FUNCTION	516
5. NC FUNCTIONS OF 20i	519
5.1 MANUAL HANDLE FEED	520
5.2 FUNCTION KEYS AND SOFT KEYS	521
5.3 SPECIAL KEY OPERATIONS	523
5.3.1 Clearing All Memory Data	523
5.3.2 Canceling Alarm 101	523

APPENDIX

A. RANGE OF COMMAND VALUE	527
A.1 T SERIES	528
A.2 M SERIES	531
B. FUNCTIONS AND TAPE FORMAT LIST	534
B.1 T SERIES	535
B.2 M SERIES	540
C. LIST OF TAPE CODE	546
D. EXTERNAL DIMENSIONS OF EACH UNIT	549

I. GENERAL

1 GENERAL

The FANUC Series 16*i*, 160*i*, 18*i*, 180*i*, 21*i*, and 210*i* are super-compact ultra-thin CNC models with built-in liquid crystal displays. Each CNC unit is a mere 60 mm deep and features, immediately behind the liquid crystal display, a small CNC printed circuit board developed by utilizing state-of-the-art LSI and surface-mount technologies.

Super-compact ultra-thin open CNC models are also available. Super-compact, ultra-thin open CNCs (the *is* series) employing Windows CE as a GUI function, and other Windows-2000-based open CNCs with high functionality are available.

The amount of cabling in the electrical unit of the machine can be significantly reduced by using a high-speed serial servo bus, which connects the CNC control unit and multiple servo amplifiers by a single optical fiber cable. Another innovation which simplifies the electrical unit of the machine tool is the use of compact distributed I/O modules, which can be separately mounted on the machine operator's panel and control panel.

The FS16*i* and 18*i* include the Ethernet function as a standard function. (With the 21*i*/20*i*, the Ethernet function is available as an optional function.) This function enables easy networking if applications to run on the personal computer are prepared.

* GUI : Graphical user interface

This manual describes the following models and may use the following abbreviations.

Model name	Abbreviation	
FANUC Series 16 <i>i</i> -TB	16 <i>i</i> -TB	T series or T series (2-path control) *1
FANUC Series 160 <i>i</i> -TB	160 <i>i</i> -TB	
FANUC Series 160 <i>is</i> -TB	160 <i>is</i> -TB	
FANUC Series 16 <i>i</i> -MB	16 <i>i</i> -MB	M series or M series (2-path control) *1
FANUC Series 160 <i>i</i> -MB	160 <i>i</i> -MB	
FANUC Series 160 <i>is</i> -MB	160 <i>is</i> -MB	
FANUC Series 18 <i>i</i> -TB	18 <i>i</i> -TB	T series or T series (2-path control) *1
FANUC Series 180 <i>i</i> -TB	180 <i>i</i> -TB	
FANUC Series 180 <i>is</i> -TB	180 <i>is</i> -TB	
FANUC Series 18 <i>i</i> -MB5	18 <i>i</i> -MB5	M series
FANUC Series 180 <i>i</i> -MB5	180 <i>i</i> -MB5	
FANUC Series 180 <i>is</i> -MB5	180 <i>is</i> -MB5	

Model name	Abbreviation	
FANUC Series 18i-MB	18i-MB	M series
FANUC Series 180i-MB	180i-MB	
FANUC Series 180is-MB	180is-MB	
FANUC Series 21i-TB	21i-TB	T series
FANUC Series 210i-TB	210i-TB	
FANUC Series 210is-TB	210is-TB	
FANUC Series 21i-MB	21i-MB	M series
FANUC Series 210i-MB	210i-MB	
FANUC Series 210is-MB	210is-MB	
FANUC Series 20i-TB	20i-TB	T series
FANUC Series 20i-FB	20i-FB	F series (See an explanation of the M series.)

*1) With two-path control function.

Special symbols

- IP

: Indicates a combination of axes such as X__ Y__ Z (used in PROGRAMMING.).

- ;

: Indicates the end of a block. It actually corresponds to the ISO code LF or EIA code CR.

Related manuals of Series 16i/18i/21i/20i/160i/180i/210i/160is/180is/210is-MODEL B

The following table lists the manuals related to Series 16i, Series 18i, Series 21i, Series 20i, Series 160i, Series 180i, Series 210i, Series 160is, Series 180is, Series 210is-MODEL B. This manual is indicated by an asterisk(*).

Related manuals of Series 16i/18i/21i/160i/180i/210i/160is/180is/210is MODEL B

Manual name	Specification number	
DESCRIPTIONS	B-63522EN	*
CONNECTION MANUAL (HARDWARE)	B-63523EN	
CONNECTION MANUAL (FUNCTION)	B-63523EN-1	
Series 16i/18i/160i/180i/160is/180is-TB OPERATOR'S MANUAL	B-63524EN	
Series 16i/160i/160is-MB, Series 18i/180i/180is-MB5, Series 18i/180i/180is-MB OPERATOR'S MANUAL	B-63534EN	
Series 21i/210i/210is-TB OPERATOR'S MANUAL	B-63604EN	
Series 21i/210i/210is-MB OPERATOR'S MANUAL	B-63614EN	
MAINTENANCE MANUAL	B-63525EN	
Series 16i/18i/160i/180i/160is/180is-MODEL B PARAMETER MANUAL	B-63530EN	
Series 21i/210i/210is-MODEL B PARAMETER MANUAL	B-63610EN	

Manual name	Specification number	
PROGRAMMING MANUAL		
Macro Compiler/Macro Executor PROGRAMMING MANUAL	B-61803E-1	
C Language Executor PROGRAMMING MANUAL	B-62443EN-3	
FANUC MACRO COMPILER (For Personal Computer) PROGRAMMING MANUAL	B-66102E	
CAP (T series)		
FANUC Super CAP <i>i</i> T OPERATOR'S MANUAL	B-63284EN	
FANUC Symbol CAP <i>i</i> T OPERATOR'S MANUAL	B-63304EN	
MANUAL GUIDE For Lathe PROGRAMMING MANUAL	B-63343EN	
MANUAL GUIDE For Lathe OPERATOR'S MANUAL	B-63344EN	
CAP (M series)		
FANUC Super CAP <i>i</i> M OPERATOR'S MANUAL	B-63294EN	
MANUAL GUIDE For Milling PROGRAMMING MANUAL	B-63423EN	
MANUAL GUIDE For Milling OPERATOR'S MANUAL	B-63424EN	
PMC		
PMC Ladder Language PROGRAMMING MANUAL	B-61863E	
PMC C Language PROGRAMMING MANUAL	B-61863E-1	
Network		
I/O Link-II OPERATOR'S MANUAL	B-62924EN	
Profibus-DP Board OPERATOR'S MANUAL	B-62924EN	
FAST Ethernet Board/FAST DATA SERVER OPERATOR'S MANUAL	B-63644EN	
Ethernet Board/DATA SERVER Board OPERATOR'S MANUAL	B-63354EN	
DeviceNet Board OPERATOR'S MANUAL	B-63404EN	
PC function		
Screen Display Function OPERATOR'S MANUAL	B-63164EN	

Related manuals of Series 20i-MODEL B

Manual name	Specification number	
DESCRIPTIONS	B-63522EN	*
CONNECTION MANUAL (HARDWARE)	B-64193EN	
CONNECTION MANUAL (FUNCTION)	B-63523EN-1	
Series 20i-TB OPERATOR'S MANUAL (For Manual Lathes)	B-64194EN	
Series 20i-FB OPERATOR'S MANUAL (For Manual Milling Machine)	B-64204EN	
OPERATOR'S MANUAL (For Manual Lathes)	B-62204E-1	
OPERATOR'S MANUAL (For Manual Milling Machine)	B-62174E-1	
MAINTENANCE MANUAL	B-64195EN	
PARAMETER MANUAL	B-64200EN	
PROGRAMMING MANUAL		
Macro Compiler/Macro Executor PROGRAMMING MANUAL	B-61803E-1	
FANUC MACRO COMPILER (For Personal Computer) PROGRAMMING MANUAL	B-66102E	
PMC		
PMC Ladder Language PROGRAMMING MANUAL	B-61863E	
Network		
FAST Ethernet Board/FAST DATA SERVER OPERATOR'S MANUAL	B-63644EN	

Related manuals of SERVO MOTOR α is/ α i/ β is series

The following table lists the manuals related to SERVO MOTOR α is/ α i/ β is series

Manual name	Specification number
FANUC AC SERVO MOTOR α is/ α i series DESCRIPTIONS	B-65262EN
FANUC AC SERVO MOTOR β is series DESCRIPTIONS	B-65302EN
FANUC AC SERVO MOTOR α is/ α i/ β is series PARAMETER MANUAL	B-65270EN
FANUC AC SPINDLE MOTOR α i series DESCRIPTIONS	B-65272EN
FANUC AC SPINDLE MOTOR β i series DESCRIPTIONS	B-65312EN
FANUC AC SPINDLE MOTOR α i/ β is series PARAMETER MANUAL	B-65280EN
FANUC SERVO AMPLIFIER α i series DESCRIPTIONS	B-65282EN
FANUC SERVO AMPLIFIER β i series DESCRIPTIONS	B-65322EN
FANUC AC SERVO MOTOR α is/ α i series, FANUC AC SPINDLE MOTOR α i series, FANUC SERVO AMPLIFIER α i series MAINTENANCE MANUAL	B-65285EN
FANUC AC SERVO MOTOR β is series, FANUC AC SPINDLE MOTOR β i series, FANUC SERVO AMPLIFIER β i series MAINTENANCE MANUAL	B-65325EN

Related manuals of SERVO MOTOR α series

The following table lists the manuals related to SERVO MOTOR α series

Manual name	Specification number
FANUC AC SERVO MOTOR α series DESCRIPTIONS	B-65142
FANUC AC SERVO MOTOR α series PARAMETER MANUAL	B-65150
FANUC AC SPINDLE MOTOR α series DESCRIPTIONS	B-65152
FANUC AC SPINDLE MOTOR α series PARAMETER MANUAL	B-65160
FANUC SERVO AMPLIFIER α series DESCRIPTIONS	B-65162
FANUC SERVO MOTOR α series MAINTENANCE MANUAL	B-65165

Either of the following servo motors and the corresponding spindle can be connected to the CNC covered in this manual.

- FANUC SERVO MOTOR α is/ α i/ β i series
- FANUC SERVO MOTOR α series

This manual mainly assumes that the FANUC SERVO MOTOR α i series of servo motor is used. For servo motor and spindle information, refer to the manuals for the servo motor and spindle that are actually connected.

2 LIST OF SPECIFICATIONS

NOTE

For details on Series 20i specifications, see Part IV.

○ : Standard ● : Standard option ☆ : Option
 ※ : Function included in another option
 — : Not available

Note) The use of some combinations of options is restricted.
 For the Series 160i/180i/210i/160is/180is/210is, the CNC screen display function is assumed to be used.

Item	Specifications	Series 16i Series 160i Series 160is		Series 18i Series 180i Series 180is			Series 21i Series 210i Series 210is	
		MB	TB	MB5	MB	TB	MB	TB

Controlled axis

Max. controlled axes (Machine controlled axes + Loader controlled axes) (Machine controlled axes are including Cs axes)	12 axes (Machine 8 axes × 1 path + Loader 4 axes)	☆	☆	☆	☆	☆	—	—
	20 axes (2 CPU 2 path) (Machine 8 axes × 2 path + Loader 4 axes)	☆	☆	—	—	☆	—	—
	12 axes (1 CPU 2 path) (Machine 4 axes × 2 path + Loader 4 axes)	—	☆	—	—	☆	—	—
	16 axes (2 CPU 3 path) (Machine 8 axes × 1 path + 4 axes × 2 path)	—	☆	—	—	—	—	—
	5 axes (Machine 5 axes)	—	—	—	—	—	☆	☆
	9 axes (Machine 5 axes × 1 path + Loader 4 axes)	—	—	—	—	—	—	☆

Note) The items marked with *1 to *16 (including such as *1-1, *1-2, and *2-1) have notes added. These notes are provided at the end of this table.

Item		Specifications	Series 16i Series 160i Series 160is		Series 18i Series 180i Series 180is			Series 21i Series 210i Series 210is	
			MB	TB	MB5	MB	TB	MB	TB
Machine controlled axes	Controlled path	1-path	○	○	○	○	○	○	○
		2-path (2 CPU 2 path)	☆	☆	—	—	☆	—	—
		2-path (1 CPU 2 path)	—	☆	—	—	☆	—	—
		3-path (2 CPU 3 path)	—	☆	—	—	—	—	—
	Controlled axis (each path)	2 axes	—	○	—	—	○	—	○
		3 axes	○	—	○	○	—	○	—
	Simultaneously controlled axes (each path)	Simultaneous 2 axes	○	○	○	○	○	○	○
	Controlled axes expansion (total) (including Cs axes)	Max. 8 axes (1 path)	☆	☆	☆	☆	☆	—	—
		Max. 8 axes (2 CPU 2 path)	☆	☆	—	—	☆	—	—
		Max. 5 axes (1 path)	—	—	—	—	—	☆	☆
		Max. 4 axes (1 CPU 2 path)	—	☆	—	—	☆	—	—
		Max. 8 axes (2 CPU 3 path)	—	☆	—	—	—	—	—
	Simultaneously controlled axes expansion (total)	Max. 6 axes	☆	☆	—	—	—	—	—
		Max. 5 axes	—	—	☆	—	—	—	—
		Max. 4 axes	—	—	—	☆	☆	☆	☆
	Axis control by PMC	Max. simultaneous 4 axes per path (Not available on Cs axis)	☆	☆	☆	☆	☆	☆	☆
	PMC axis control expansion	Axis control by PMC is required.	☆	☆	☆	☆	☆	☆	—
	Function of CNC axis waiting during PMC axis control	PMC axis control expansion is required.	*	*	*	*	*	*	*
	Cs contouring control	Max. 4 axes (1 path)	☆	☆	—	—	—	—	—
		Max. 3 axes (1 path)	—	—	☆	☆	☆	—	—
Max. 2 axes (1 path)		—	—	—	—	—	☆	☆	
4 axes for each path (2 CPU 2 path)		☆	☆	—	—	—	—	—	
3 axes for each path (2 CPU 2 path)		—	—	—	—	☆	—	—	
2 axes for each path (1 CPU 2 path) *3		—	☆	—	—	☆	—	—	
2 axes for each path (2 CPU 3 path)		—	☆	—	—	—	—	—	
Loader controlled axes	Controlled path	1 path	☆	☆	☆	☆	☆	—	☆
	Controlled axes	Max. 4 axes	☆	☆	☆	☆	☆	—	☆
	Simultaneously controlled axes	Max. 4 axes	☆	☆	☆	☆	☆	—	☆
	Axis control by PMC	Max. 4 axes	☆	☆	☆	☆	☆	—	☆
Compound machining function	Only for 1 path	—	☆	—	—	☆	—	—	
Axis name	Basic three axes are X, Y and Z, additional axes are optional from U, V, W, A, B and C.	○	—	○	○	—	○	—	
	In case of G code system A, basic 2 axes are X and Z, additional axes are optional from Y, A, B and C.	—	○	—	—	○	—	○	
Axis name	In case of G code system B/C, basic 2 axes are X and Z, additional axes are optional from Y, U, V, W, A, B and C.	—	*	—	—	*	—	*	

Note) The items marked with *1 to *16 (including such as *1-1, *1-2, and *2-1) have notes added. These notes are provided at the end of this table.

Item	Specifications	Series 16i Series 160i Series 160is		Series 18i Series 180i Series 180is			Series 21i Series 210i Series 210is	
		MB	TB	MB5	MB	TB	MB	TB
Servo motor connection number expansion at torque tandem control		☆	—	☆	☆	—	—	—
Axis recomposition	Only for 2 path	—	☆	—	—	☆	—	—
Synchronous operation control	Only for 1 path	—	☆	—	—	☆	—	—
Simple synchronous control	1 pair	—	☆	—	—	☆	☆	☆
	4 pairs	☆	—	☆	☆	—	—	—
Twin table control		☆	—	☆	☆	—	☆	—
Bar feeder control		—	☆	—	—	☆	—	☆
Angular axis control		☆	☆	☆	☆	☆	☆	☆
Arbitrary angular axis control		☆	☆	☆	☆	☆	—	☆
B-axis control		—	☆	—	—	☆	—	☆
Tandem control		☆	☆	☆	☆	☆	☆	☆
Tandem Disturbance Elimination control	Simple synchronous control is required.	☆	☆	☆	☆	☆	—	—
Oscillation command by PMC axis	PMC axis control is required.	☆	☆	☆	☆	☆	☆	☆
Torque control	Included in PMC axis control	*	*	*	*	*	—	—
Control axis detach		☆	☆	☆	☆	☆	☆	☆
Chopping		☆	—	☆	☆	—	—	—
Least input increment	0.001mm, 0.001deg, 0.0001inch	○	○	○	○	○	○	○
Increment system 1/10	0.0001mm, 0.0001deg, 0.00001inch	☆	☆	☆	☆	☆	☆	☆
Increment system 1/100	0.00001mm, 0.00001deg, 0.000001inch	—	☆	—	—	☆	—	—
Flexible feed gear	Optional DMR	○	○	○	○	○	○	○
Learning control		☆	☆	☆	☆	☆	—	—
Preview repetitive control		☆	☆	☆	☆	☆	—	—
Dual position feedback		☆	☆	☆	☆	☆	☆	☆
Learning memory expansion		☆	☆	☆	☆	☆	—	—
Fine Acc & Dec control		○	○	○	○	○	○	○
HRV control		○	○	○	○	○	○	○
High speed HRV control		○	○	○	○	○	○	—
Inch/metric conversion		☆	☆	☆	☆	☆	☆	☆
Interlock	All axes/each axis/each direction/block start/cutting block start	○	○	○	○	○	○	○
Machine lock	All axes/each axis	○	○	○	○	○	○	○
Emergency stop		○	○	○	○	○	○	○
Overtravel		○	○	○	○	○	○	○
Stored stroke check 1		○	○	○	○	○	○	○
Stroke limit external setting		☆	—	☆	☆	—	☆	—
Stored stroke check 2		☆	—	☆	☆	—	☆	—
Stored stroke check 3		☆	—	☆	☆	—	—	—
Stored stroke check 2, 3		—	☆	—	—	☆	—	☆
Stroke limit check before move		☆	☆	☆	☆	☆	☆	—
Chuck and tail stock barrier		—	☆	—	—	☆	—	☆

Note) The items marked with *1 to *16 (including such as *1-1, *1-2, and *2-1) have notes added. These notes are provided at the end of this table.

Item	Specifications	Series 16i Series 160i Series 160is		Series 18i Series 180i Series 180is			Series 21i Series 210i Series 210is	
		MB	TB	MB5	MB	TB	MB	TB
Mirror image	Each axis	○	○	○	○	○	○	○
Follow-up		○	○	○	○	○	○	○
Servo off/mechanical handle feed		○	○	○	○	○	○	○
Chamfering on/off		—	○	—	—	○	—	○
Interference check between 2-path	<ul style="list-style-type: none"> • Only for 2 path • Tool offset number is available to max.64 in this function 	☆	☆	—	—	☆	—	—
Interference check for rotary area		☆	☆	☆	☆	☆	—	—
Unexpected disturbance torque detection function		☆	☆	☆	☆	☆	☆	☆
Fine torque sensing		☆	☆	☆	☆	☆	—	—
Rotary axis control		☆	☆	☆	☆	☆	—	—
Position switch		☆	☆	☆	☆	☆	☆	☆
High-speed position switch		☆	☆	☆	☆	☆	—	—
Direction-dependent type high-speed position switch		☆	☆	☆	☆	☆	—	—
Linear scale I/F with absolute address reference mark		☆	☆	☆	☆	☆	☆	☆
Linear scale with absolute address reference mark expansion		☆	☆	☆	☆	☆	☆	☆
Temporary absolute coordinate setting		☆	☆	☆	☆	☆	—	☆
Dual check safety		☆	☆	☆	☆	☆	☆	☆
Inclined rotary axis control	RISC board is required. *15	☆	—	☆	—	—	—	—

Operation

Automatic operation (memory)		○	○	○	○	○	○	○
MDI operation		○	○	○	○	○	○	○
DNC operation	Reader/puncher interface is required.	*	*	*	*	*	*	*
DNC operation with Memory Card	PCMCIA Card Attachment is required. *1-3	*	*	*	*	*	*	*
Schedule function	Only for 1 path	*	*	*	*	*	*	*
Program number search		○	○	○	○	○	○	○
Sequence number search		○	○	○	○	○	○	○
Sequence number comparison and stop		☆	☆	☆	☆	☆	☆	☆
Program restart		☆	☆	☆	☆	☆	☆	☆
Tool retract and recover		☆	☆	☆	☆	☆	—	—
Manual intervention and return		○	○	○	○	○	○	○
Retraction for rigid tapping		☆	—	☆	☆	—	☆	—
Buffer register		○	○	○	○	○	○	○
Dry run		○	○	○	○	○	○	○
Single block		○	○	○	○	○	○	○
Jog feed		○	○	○	○	○	○	○

Note) The items marked with *1 to *16 (including such as *1-1, *1-2, and *2-1) have notes added. These notes are provided at the end of this table.

Item	Specifications	Series 16i Series 160i Series 160is		Series 18i Series 180i Series 180is			Series 21i Series 210i Series 210is	
		MB	TB	MB5	MB	TB	MB	TB
Manual reference position return		○	○	○	○	○	○	○
Reference position setting without DOG		○	○	○	○	○	○	○
Reference position setting with mechanical stopper		☆	☆	☆	☆	☆	☆	☆
Reference position shift		☆	☆	☆	☆	☆	—	—
Manual handle feed	1 unit/each path	☆	☆	☆	☆	☆	☆	☆
	2 units	—	☆	—	—	☆	—	☆
	2 units/3 units	☆	—	☆	☆	—	☆	—
Manual handle feed rate	× 1, × 10, × m, × n m: 0 to 127, n: 0 to 1000	*	*	*	*	*	*	*
Tool direction handle feed		☆	—	☆	☆	—	—	—
Tool direction handle feed B	Tool direction + normal direction	☆	—	☆	☆	—	—	—
Manual feed for 5-axis machining		☆	☆	☆	—	—	—	—
Manual handle interruption		☆	☆	☆	☆	☆	☆	☆
Incremental feed	× 1, × 10, × 100, × 1000	○	○	○	○	○	○	○
Jog and handle simultaneous mode		*	*	*	*	*	*	*
Manual numerical command		☆	☆	☆	☆	☆	—	—
Manual liner/circular interpolation	Only for 1 path	☆	☆	☆	☆	☆	☆	—
Retrace		☆	—	☆	☆	—	☆	—
Manual handle retrace	Manual handle feed is required.	—	☆	—	—	☆	—	☆
Reference position signal output		—	☆	—	—	☆	—	☆

Interpolation functions

Positioning	G00 (Linear interpolation type positioning is possible)	○	○	○	○	○	○	○
Single direction positioning	G60	☆	☆	☆	☆	☆	☆	—
Exact stop mode	G61	○	—	○	○	—	○	—
Tapping mode	G63	○	—	○	○	—	○	—
Cutting mode	G64	○	—	○	○	—	○	—
Exact stop	G09	○	—	○	○	—	○	—
Linear interpolation		○	○	○	○	○	○	○
Circular interpolation	Multi-quadrant is possible	○	○	○	○	○	○	○
Exponential interpolation		☆	—	☆	☆	—	—	—
Dwell	Dwell in seconds and dwell in revolution (In case of dwell in revolution for M system, threading, synchronous cutting option is required.)	○	○	○	○	○	○	○
Polar coordinate interpolation		☆	☆	☆	☆	☆	—	☆
Cylindrical interpolation		☆	☆	☆	☆	☆	☆	☆
Helical interpolation	Circular interpolation plus max. 2 axes linear interpolation	☆	☆	☆	☆	☆	☆	—
Helical interpolation B	Circular interpolation plus max. 4 axes linear interpolation *13 *14	☆	☆	—	—	—	—	—
Involute interpolation		☆	—	☆	☆	—	—	—

(Note) The items marked with *1 to *16 (including such as *1-1, *1-2, and *2-1) have notes added. These notes are provided at the end of this table.

Item	Specifications	Series 16i Series 160i Series 160is		Series 18i Series 180i Series 180is			Series 21i Series 210i Series 210is	
		MB	TB	MB5	MB	TB	MB	TB
Hypothetical axis interpolation		☆	☆	☆	☆	☆	—	—
Conical/spiral interpolation	*13 *14	☆	☆	☆	☆	☆	—	—
Smooth interpolation	*15 *16	☆	☆	☆	☆	☆	—	—
Nano Smoothing		☆	—	☆	☆	—	—	—
Threading, synchronous cutting		☆	○	☆	☆	○	☆	○
Multiple threading		—	○	—	—	○	—	○
Threading retract		—	☆	—	—	☆	—	☆
Continuous threading		—	☆	—	—	☆	—	☆
Variable lead threading		—	☆	—	—	☆	—	☆
Circular threading		—	☆	—	—	☆	—	—
Polygon turning		—	☆	—	—	☆	—	☆
Polygon machining with two spindles		—	☆	—	—	☆	—	☆
Skip	G31	○	○	○	○	○	○	○
Multi-step skip		☆	☆	☆	☆	☆	☆	☆
High-speed skip	Input signal is 8 points, but 21i/210i/210is are only 1 point.	☆	☆	☆	☆	☆	☆	☆
Continuous high-speed skip		☆	—	☆	☆	—	—	—
Torque limit skip		○	○	○	○	○	—	○
Reference position return	G28	○	○	○	○	○	○	○
Reference position return check	G27	○	○	○	○	○	○	○
2nd reference position return		○	○	○	○	○	○	○
3rd/4th reference position return		☆	☆	☆	☆	☆	☆	☆
Floating reference position return		☆	☆	☆	☆	☆	—	—
Normal direction control		☆	—	☆	☆	—	☆	—
Gentle normal direction control		☆	—	☆	☆	—	—	—
NURBS interpolation	*15 *16	☆	☆	☆	☆	☆	—	—
Three-dimensional circular interpolation	RISC board is required. *14 *15	☆	☆	☆	—	—	—	—
Continuous dressing	For grinding machine	☆	—	☆	☆	—	☆	—
Infeed control	For grinding machine	☆	—	☆	☆	—	☆	—
Balance cutting	Only for 2 path	—	☆	—	—	☆	—	—
Index table indexing		☆	—	☆	☆	—	☆	—
High-speed cycle cutting	Only for 1 path	☆	☆	☆	☆	☆	—	—
Retract of high-speed cycle cutting		☆	☆	☆	☆	☆	—	—
High-speed linear interpolation		☆	—	☆	☆	—	—	—
General purpose retract		☆	☆	☆	☆	☆	☆	☆

Note) The items marked with *1 to *16 (including such as *1-1, *1-2, and *2-1) have notes added. These notes are provided at the end of this table.

Item	Specifications	Series 16i Series 160i Series 160is		Series 18i Series 180i Series 180is			Series 21i Series 210i Series 210is	
		MB	TB	MB5	MB	TB	MB	TB

Feed function

Rapid traverse rate	Max. 240m/min (1 μ m)	○	○	○	○	○	○	○
	Max. 100m/min (0.1 μ m)	*	*	*	*	*	*	*
	Max. 10m/min (0.01 μ m)	—	*	—	—	*	—	—
Rapid traverse override	Fo, 25, 50, 100% or 0 to 100% (1% Step)	○	○	○	○	○	○	○
Feed per minute		○	○	○	○	○	○	○
Feed per revolution	For M system, threading, synchronous cutting option is required.	*	○	*	*	○	*	○
Without position coder feed per revolution	Included in Without position coder constant surface speed control.	—	*	—	—	*	—	*
Without position coder constant surface speed control		—	☆	—	—	☆	—	☆
Tangential speed constant control		○	○	○	○	○	○	○
Cutting feedrate clamp		○	○	○	○	○	○	○
Automatic acceleration/decel- eration	Rapid traverse: linear Cutting feed: exponential	○	○	○	○	○	○	○
Rapid traverse bell-shaped acceleration/deceleration		☆	☆	☆	☆	☆	☆	☆
Positioning by optimal acceleration		☆	☆	☆	☆	☆	☆	—
Optimum torque acceleration/deceleration	AI high-precision contour con- trol or AI nano high-precision contour control is required. *15	☆	☆	☆	☆	☆	—	—
Linear acceleration/deceleration after cutting feed interpolation		☆	☆	☆	☆	☆	☆	☆
Bell-shaped acceleration/ deceleration after cutting feed interpolation		☆	☆	☆	☆	☆	☆	☆
Linear acceleration/deceleration before cutting feed interpolation	For M system, feed per minute only	☆	☆	☆	☆	☆	—	—
Feedrate override	0 to 254%	○	○	○	○	○	○	○
2nd feedrate override	0 to 254%	☆	☆	☆	☆	☆	—	—
One-digit F code feed		☆	—	☆	☆	—	☆	—
Inverse time feed		☆	—	☆	☆	—	☆	—
Jog override	0 to 655.34%	○	○	○	○	○	○	○
Override cancel		○	○	○	○	○	○	○
Manual per revolution feed		—	○	—	—	○	—	○
The stop position setting with the manual feed		—	☆	—	—	☆	—	☆
External deceleration		☆	☆	☆	☆	☆	☆	☆
Feed stop		☆	☆	☆	☆	☆	—	—
Advanced preview control		☆	☆	☆	☆	☆	☆	—
AI advanced preview control		—	—	—	—	—	☆	—
AI contour control		☆	—	☆	☆	—	☆	—
AI nano contour control		☆	☆	☆	☆	☆	☆	—

Note) The items marked with *1 to *16 (including such as *1-1, *1-2, and *2-1) have notes added. These notes are provided at the end of this table.

Item	Specifications	Series 16i Series 160i Series 160is		Series 18i Series 180i Series 180is			Series 21i Series 210i Series 210is	
		MB	TB	MB5	MB	TB	MB	TB
Bell-shaped acceleration/ deceleration before look ahead interpolation	AI contour control or AI nano contour control is required.	☆	—	☆	☆	—	☆	—
High-precision contour control	RISC board is required. *15	☆	☆	☆	☆	☆	—	—
AI high-precision contour control	Look-ahead block no. is Max. 600. RISC board is required. *15	☆	☆	☆	☆	☆	—	—
AI nano high-precision contour control	Look-ahead block no. is Max. 600. RISC board is required. *15	☆	☆	☆	☆	☆	—	—
Jerk control	Any of following functions is required. • Bell-type acceleration/ deceleration before look ahead interpolation • AI high-precision contour control (*15) • AI nano high-precision contour control (*15) *13	☆	☆	☆	☆	☆	☆	—
Rigid tapping bell-shaped acceleration/deceleration	Rigid tapping is required.	☆	—	☆	☆	—	☆	—

Program input

Tape code	EIA RS244/ISO840	○	○	○	○	○	○	○
Label skip		○	○	○	○	○	○	○
Parity check	Horizontal and vertical parity	○	○	○	○	○	○	○
Control in/out		○	○	○	○	○	○	○
Optional block skip	1	○	○	○	○	○	○	○
	9	☆	☆	☆	☆	☆	☆	☆
Max. programmable dimension	±8-digit	○	○	○	○	○	○	○
Program number	O4-digit	○	○	○	○	○	○	○
	O8-digit	☆	☆	☆	☆	☆	—	—
Sequence number	N5-digit	○	○	○	○	○	○	○
Absolute/incremental programming	Combined use in the same block	○	○	○	○	○	○	○
Decimal point programming/ pocket calculator type decimal point programming		○	○	○	○	○	○	○
Input unit 10 time multiply		○	○	○	○	○	○	○
Diameter/Radius programming (X axis)		—	○	—	—	○	—	○
Diameter/Radius Dynamic Switching		—	☆	—	—	☆	—	—
Plane selection	G17, G18, G19	○	○	○	○	○	○	○
Rotary axis designation		○	○	○	○	○	○	○
Rotary axis roll-over		○	○	○	○	○	○	○
Polar coordinate command		☆	—	☆	☆	—	☆	—
Coordinate system setting		○	○	○	○	○	○	○
Automatic coordinate system setting		○	○	○	○	○	○	○

Note) The items marked with *1 to *16 (including such as *1-1, *1-2, and *2-1) have notes added. These notes are provided at the end of this table.

Item	Specifications	Series 16i Series 160i Series 160is		Series 18i Series 180i Series 180is			Series 21i Series 210i Series 210is	
		MB	TB	MB5	MB	TB	MB	TB
Coordinate system shift		—	○	—	—	○	—	○
Direct input of coordinate system shift		—	○	—	—	○	—	○
Workpiece coordinate system	G52 to G59	☆	☆	☆	☆	☆	☆	☆
Workpiece coordinate system preset		☆	☆	☆	☆	☆	☆	☆
Addition of workpiece coordinate system pair	48 pairs	☆	☆	☆	☆	☆	☆	—
	300 pairs	☆	—	☆	☆	—	—	—
Direct input of workpiece origin offset value measured		*	*	*	*	*	*	*
Manual absolute on and off		○	○	○	○	○	○	○
Direct drawing dimension programming		—	☆	—	—	☆	—	☆
G code system	A	—	○	—	—	○	—	○
	B/C	—	☆	—	—	☆	—	☆
Chamfering/corner R		—	☆	—	—	☆	—	☆
Optional chamfering/corner R		☆	—	☆	☆	—	☆	—
Programmable data input	G10	☆	☆	☆	☆	☆	☆	☆
Programmable parameter input	Included in Programmable data input.	*	*	*	*	*	*	*
Sub program call	4 folds nested	○	○	○	○	○	○	○
Custom macro B		☆	☆	☆	☆	☆	☆	☆
Addition of custom macro common variables	#100 to #199, #500 to #999	☆	☆	☆	☆	☆	☆	☆
Macro variables common with both 2 path	For 2 path	*	*	—	—	*	—	—
Pattern data input		☆	☆	☆	☆	☆	☆	☆
Interruption type custom macro		☆	☆	☆	☆	☆	☆	☆
Embedded macro		☆	☆	☆	☆	☆	☆	☆
Embedded macro for milling	Embedded macro is required.	☆	—	☆	☆	—	☆	—
Canned cycles		—	○	—	—	○	—	○
Mmultiple repetitive cycle		—	☆	—	—	☆	—	☆
Mmultiple repetitive cycle II	Pocket profile	—	☆	—	—	☆	—	☆
Canned cycles for drilling		☆	☆	☆	☆	☆	☆	☆
Small-hole peck drilling cycle		☆	—	☆	☆	—	☆	—
Canned cycles for grinding	For grinding machine	☆	☆	☆	☆	☆	☆	—
Circular interpolation by R programming		○	○	○	○	○	○	○
Circular interpolation by 9-digit R designation		☆	☆	☆	☆	☆	—	—
Mirror image for double turret		—	☆	—	—	☆	—	☆
Automatic corner override		☆	☆	☆	☆	☆	☆	—
Automatic corner deceleration		☆	—	☆	☆	—	☆	—
Feedrate clamp based on arc radius		☆	—	☆	☆	—	☆	—
Scaling	*14 *15	☆	☆	☆	☆	☆	☆	—
Coordinate system rotation		☆	☆	☆	☆	☆	☆	—
Three-dimensional coordinate conversion		☆	☆	☆	☆	☆	☆	☆

Note) The items marked with *1 to *16 (including such as *1-1, *1-2, and *2-1) have notes added. These notes are provided at the end of this table.

Item	Specifications	Series 16i Series 160i Series 160is		Series 18i Series 180i Series 180is			Series 21i Series 210i Series 210is	
		MB	TB	MB5	MB	TB	MB	TB
Tilted working plane command		☆	—	☆	☆	—	—	—
Programmable mirror image	*14 *15	☆	☆	☆	☆	☆	☆	—
Figure copy		☆	—	☆	☆	—	—	—
Tape format for FANUC Series 15		☆	☆	☆	☆	☆	—	—
Tape format for FANUC Series 10/11		—	—	—	—	—	☆	☆
Conversational programming with graphic function	Only for 1 path	☆	☆	☆	☆	☆	☆	—
Macro executor	*4	☆	☆	☆	☆	☆	☆	☆
Expanded P code macro variable 20000		☆	☆	☆	☆	☆	☆	☆
C language executor	*4	☆	☆	☆	☆	☆	☆	☆

Conversational programming function for machining center

Super CAP i M	*1-1	☆	—	☆	☆	—	☆	—
NC format output	*1-1	☆	—	☆	☆	—	☆	—
Conversational C language programming	*1-1	☆	—	☆	☆	—	☆	—
Contour figure repetition	*1-1	☆	—	☆	☆	—	☆	—
Background graphic	*1-1	☆	—	☆	☆	—	—	—
U-axis conversational programming	*1-1	☆	—	☆	☆	—	☆	—
Contour pocket machining B	*1-1	☆	—	☆	☆	—	☆	—
Contour figure block number expansion	*1-1	☆	—	☆	☆	—	☆	—

Operation guidance function for milling machine

MANUAL GUIDE	*1-1	☆	—	☆	☆	—	☆	—
Guidance cutting	*1-1	☆	—	☆	☆	—	☆	—

Conversational programming function for lathe

Super CAP i T	For 1 path lathe For 2 path lathe For 3 path lathe	*1-1	—	☆	—	—	☆	—	☆
NC format output		*1-1	—	☆	—	—	☆	—	☆
C-axis conversational programming		*1-1	—	☆	—	—	☆	—	☆
Y-axis conversational programming		*1-1	—	☆	—	—	☆	—	☆
P code macro variable 4000		*1-1	—	☆	—	—	☆	—	☆
Back machining by sub-spindle		*1-1	—	☆	—	—	☆	—	☆
Chuck data extension	60	*1-1	—	☆	—	—	☆	—	☆
T code offset pair extension		*1-1	—	☆	—	—	☆	—	☆
Animated simulation interference check		*1-1	—	☆	—	—	☆	—	☆
Complex Lathe Application	Only for 2 path	*1-1	—	☆	—	—	☆	—	—

Note) The items marked with *1 to *16 (including such as *1-1, *1-2, and *2-1) have notes added. These notes are provided at the end of this table.

Item	Specifications		Series 16i Series 160i Series 160is		Series 18i Series 180i Series 180is			Series 21i Series 210i Series 210is	
			MB	TB	MB5	MB	TB	MB	TB
Complex Lathe Application for 3 path control	Only for 3 path	*1-1	—	☆	—	—	—	—	—
Contour Grooving		*1-1	—	☆	—	—	☆	—	☆
Contour Grooving Function with Button Tool		*1-1	—	☆	—	—	☆	—	☆
Spindle positioning type Y-axis milling		*1-1	—	☆	—	—	☆	—	☆
Symbol CAP <i>i</i> T	For 1 path lathe For 2 path lathe	*1-1	—	☆	—	—	☆	—	☆
Sub cycle function		*1-1	—	☆	—	—	☆	—	☆
Extended sub cycle function		*1-1	—	☆	—	—	☆	—	☆
Automatic process determination		*1-1	—	☆	—	—	☆	—	☆
Automatic process determination function B		*1-1	—	☆	—	—	☆	—	☆
Animated simulation function		*1-1	—	☆	—	—	☆	—	☆
Animated simulation function for vertical lathe		*1-1	—	☆	—	—	☆	—	☆
C-axis process function		*1-1	—	☆	—	—	☆	—	☆
C-axis process function B		*1-1	—	☆	—	—	☆	—	☆
Y-axis process function		*1-1	—	☆	—	—	☆	—	☆
Back machining function		*1-1	—	☆	—	—	☆	—	☆
Balance cut process function	Only for 2 path	*1-1	—	☆	—	—	☆	—	—
Conversational screen display language change over		*1-1	—	☆	—	—	☆	—	☆
Sub memory addition		*1-1	—	☆	—	—	☆	—	☆
Registration of file name to floppy cassette		*1-1	—	☆	—	—	☆	—	☆
Next tool preparation		*1-1	—	☆	—	—	☆	—	☆

Operation guidance function for general purpose lathe

Manual guide	For 1 path lathe	*1-1	—	☆	—	—	☆	—	☆
Minus X Area cutting function		*1-1	—	☆	—	—	☆	—	☆
C-axis machining A function		*1-1	—	☆	—	—	☆	—	☆
Back side Tool post function		*1-1	—	☆	—	—	☆	—	☆

Integrated Operation guidance function

MANUAL GUIDE <i>i</i> Basic		*1-1	☆	☆	☆	☆	☆	☆	☆
MANUAL GUIDE <i>i</i> Milling Cycle		*1-1	☆	☆	☆	☆	☆	☆	☆
MANUAL GUIDE <i>i</i> Turning Cycle		*1-1	—	☆	—	—	☆	—	☆
MANUAL GUIDE <i>i</i> Animation		*1-1	☆	☆	☆	☆	☆	☆	☆
MANUAL GUIDE <i>i</i> Set-up Guidance		*1-1	☆	☆	☆	☆	☆	☆	☆
MANUAL GUIDE <i>i</i> Multi path lathe function		*1-1	—	☆	—	—	☆	—	—
MANUAL GUIDE <i>i</i> Spindle movement animation for automatic lathe		*1-1	—	☆	—	—	☆	—	—

Note) The items marked with *1 to *16 (including such as *1-1, *1-2, and *2-1) have notes added. These notes are provided at the end of this table.

Item	Specifications	Series 16i Series 160i Series 160is		Series 18i Series 180i Series 180is			Series 21i Series 210i Series 210is	
		MB	TB	MB5	MB	TB	MB	TB

Auxiliary/Spindle speed function

Auxiliary function	M8-digit	○	○	○	○	○	○	○
2nd auxiliary function	B8-digit	☆	☆	☆	☆	☆	☆	☆
Auxiliary function lock		○	○	○	○	○	○	○
High-speed M/S/T/B interface		○	○	○	○	○	○	○
Waiting function	Only for 2 path	○	○	—	—	○	—	—
Multiple command of auxiliary function	3	○	○	○	○	○	○	○
M code group check		☆	☆	☆	☆	☆	—	—
Spindle speed function	S5-digit, binary output	○	○	○	○	○	○	○
Spindle serial output	S5-digit, serial output (1st/2nd)	☆	☆	☆	☆	☆	☆	☆
3rd spindle serial output		—	—	☆	☆	☆	—	—
3rd /4th spindle serial output		☆	☆	—	—	—	—	—
Spindle analog output	S5-digit, analog output	☆	☆	☆	☆	☆	☆	☆
Constant surface speed control		☆	☆	☆	☆	☆	☆	☆
Spindle override	0 to 254%	*	*	*	*	*	*	*
Actual spindle speed output		—	☆	—	—	☆	—	☆
Spindle speed fluctuation detection		☆	☆	☆	☆	☆	—	☆
1st spindle orientation		☆	☆	☆	☆	☆	☆	☆
1st spindle output switching function		☆	☆	☆	☆	☆	☆	☆
2nd spindle orientation		☆	☆	☆	☆	☆	☆	☆
2nd spindle output switching function		☆	☆	☆	☆	☆	☆	☆
3rd spindle orientation		—	—	☆	☆	☆	—	—
3rd spindle output switching function		—	—	☆	☆	☆	—	—
3rd/4th spindle orientation		☆	☆	—	—	—	—	—
3rd/4th spindle output switching function		☆	☆	—	—	—	—	—
Spindle synchronous control		☆	☆	☆	☆	☆	☆	☆
Spindle simple synchronous control		☆	☆	☆	☆	☆	☆	☆
Multi spindle control		☆	☆	☆	☆	☆	—	☆
Spindle positioning		—	☆	—	—	☆	—	☆
Rigid tapping		☆	☆	☆	☆	☆	☆	☆
Three-dimensional rigid tapping		☆	☆	☆	☆	☆	☆	—
Rigid tapping by manual handle		☆	—	☆	☆	—	—	—

Tool function/Tool compensation

Tool function	T7+1/T6+2 digits	—	○	—	—	○	—	○
	T8 digits	○	—	○	○	—	○	—

Note) The items marked with *1 to *16 (including such as *1-1, *1-2, and *2-1) have notes added. These notes are provided at the end of this table.

Item	Specifications	Series 16i Series 160i Series 160is		Series 18i Series 180i Series 180is			Series 21i Series 210i Series 210is	
		MB	TB	MB5	MB	TB	MB	TB
Tool offset pairs (Note) In case of Interference Check between 2-path, the maximum tool number is 64.	±6 digts 9/16 pairs	—	○	—	—	○	—	○
	±6 digts 32	○	☆	○	○	☆	○	☆
	±6 digts 64	☆	☆	☆	☆	☆	☆	☆
	±6 digts 99	☆	☆	☆	☆	☆	☆	—
	±6 digts 200	☆	—	☆	☆	—	☆	—
	±6 digts 400	☆	☆	☆	☆	☆	☆	—
	±6 digts 499	☆	—	☆	☆	—	—	—
	±6 digts 999	☆	☆	☆	☆	☆	—	—
Tool offset memory B	Geometry/wear memory	☆	—	☆	☆	—	☆	—
Tool offset memory C	Distinction between geometry and wear, or between cutter and tool length compensation.	☆	—	☆	☆	—	☆	—
Tool length compensation		○	—	○	○	—	○	—
Tool offset		☆	○	☆	☆	○	☆	○
Tool length compensation in tool axis direction	RISC board is required. *15	☆	—	☆	—	—	—	—
Tool center point control for 5-axis machining	RISC board is required. *14 *15	☆	☆	☆	—	—	—	—
Y-axis offset		—	☆	—	—	☆	—	☆
Cutter compensation B		☆	—	☆	☆	—	—	—
Cutter compensation C		☆	—	☆	☆	—	☆	—
Three-dimensional cutter compensation		☆	—	☆	☆	—	—	—
Tool radius compensation for 5-axis machining	RISC board is required. *14 *15	☆	☆	☆	—	—	—	—
Cutting point interpolation for cylindrical interpolation	RISC board is required. *14 *15	☆	☆	☆	☆	☆	—	—
Tool nose radius compensation		—	☆	—	—	☆	—	☆
Tool geometry/wear compensation		—	☆	—	—	☆	—	☆
2nd geometry tool offset		—	☆	—	—	☆	—	☆
Addition of tool pairs for 2nd geometry tool offset (32pairs)		—	☆	—	—	☆	—	—
Tool life management		☆	☆	☆	☆	☆	☆	☆
Addition of tool pairs for tool life management	128 pairs	—	☆	—	—	☆	—	—
	512 pairs	☆	—	☆	☆	—	☆	—
Tool life management B		☆	—	☆	☆	—	—	—
Extended tool life management		*	—	*	*	—	*	—
Tool management function	Only for 1 path. Tool 64 pairs.	☆	☆	☆	☆	☆	☆	☆
Tool management function 240pairs	Only for 1 path. Tool 240 pairs.	☆	☆	☆	☆	☆	☆	☆
Tool management function 1000pairs	Only for 1 path. Tool 1000 pairs.	☆	☆	☆	☆	☆	☆	☆
Add. customized data on Tool management function	Only for 1 path. Customized data add. 16 pairs.	☆	☆	☆	☆	☆	☆	☆
Tool offset value counter input		—	○	—	—	○	—	○
Tool offset value 7 digits		—	☆	—	—	☆	—	—
Tool length measurement		☆	—	☆	☆	—	☆	—

Note) The items marked with *1 to *16 (including such as *1-1, *1-2, and *2-1) have notes added. These notes are provided at the end of this table.

Item	Specifications	Series 16i Series 160i Series 160is		Series 18i Series 180i Series 180is			Series 21i Series 210i Series 210is	
		MB	TB	MB5	MB	TB	MB	TB
Automatic tool length measurement		☆	—	☆	☆	—	☆	—
Tool length/work zero point measurement B		☆	—	☆	☆	—	—	—
Automatic tool offset		—	☆	—	—	☆	—	☆
Direct input of tool offset value measured		—	○	—	—	○	—	○
Direct input of tool offset value measured B		—	☆	—	—	☆	—	☆
Direct input of offset value measured B for 2 spindle lathe		—	☆	—	—	☆	—	☆
Guidance for machining preparation	Manual guide is required.	☆	☆	☆	☆	☆	☆	☆
Measurement cycle	Embedded macro or Manual guide is required.	☆	—	☆	☆	—	☆	—
Wheel wear compensation		☆	—	☆	☆	—	—	—
Automatic alteration of tool position compensation		—	☆	—	—	☆	—	—
Rotary table dynamic fixture offset		☆	—	☆	☆	—	—	—
Changing active offset value with manual move		☆	☆	☆	☆	☆	☆	☆

Accuracy compensation function

Backlash compensation		○	○	○	○	○	○	○
Backlash compensation for each rapid traverse and cutting feed		○	○	○	○	○	○	○
Smooth backlash compensation		☆	☆	☆	☆	☆	—	—
Stored pitch error compensation		☆	☆	☆	☆	☆	☆	☆
Interpolation type pitch error compensation	Stored pitch error compensation is required.	☆	☆	☆	☆	☆	—	—
Bi-directional pitch error compensation	Stored pitch error compensation is required.	☆	☆	☆	☆	☆	—	☆
Extended bi-directional pitch error compensation	Stored pitch error compensation, Bi-directional pitch error compensation are required.	☆	☆	☆	☆	☆	—	☆
Periodical secondary pitch error compensation	Stored pitch error compensation is required.	☆	☆	☆	☆	☆	—	—
Inclination compensation		☆	☆	☆	☆	☆	☆	—
Straightness compensation		☆	☆	☆	☆	☆	—	—
Straightness compensation 128 points	Included in interpolation type straightness compensation.	*	*	*	*	*	—	—
Interpolation type straightness compensation	Stored pitch error compensation is required.	☆	☆	☆	☆	☆	—	—
Thermal growth compensation along tool vector		☆	—	☆	—	—	—	—

Hobbing/Electric gear box

Function for hobbing machine		☆	—	☆	☆	—	—	—
Hobbing function		—	☆	—	—	☆	—	—

Note) The items marked with *1 to *16 (including such as *1-1, *1-2, and *2-1) have notes added. These notes are provided at the end of this table.

Item	Specifications	Series 16i Series 160i Series 160is		Series 18i Series 180i Series 180is			Series 21i Series 210i Series 210is	
		MB	TB	MB5	MB	TB	MB	TB
Simple electric gear box		☆	—	☆	☆	—	☆	—
Skip function for EGB axis	Simple electric gear box is required.	☆	—	☆	☆	—	—	—
Electric gear box 2 pair	Simple electric gear box is required.	☆	—	☆	☆	—	—	—
Electric gear box automatic phase synchronization	Simple electric gear box is required.	☆	—	☆	☆	—	—	—
Spindle electric gear box	Simple electric gear box, Cs contouring control are required.	☆	—	☆	☆	—	—	—
Flexible synchronous control		☆	—	☆	☆	—	—	—

Editing operation

Part program storage length *5	10m (4Kbyte)	—	—	—	—	—	○	○
	20m (8Kbyte)	—	—	○	○	○	☆	☆
	40m (16Kbyte)	○	○	☆	☆	☆	☆	☆
	80m (32Kbyte)	☆	☆	☆	☆	☆	☆	☆
	160m (64Kbyte)	☆	☆	☆	☆	☆	☆	☆
	320m (128Kbyte)	☆	☆	☆	☆	☆	☆	☆
	640m (256Kbyte)	☆	☆	☆	☆	☆	☆	☆
	1280m (512Kbyte)	☆	☆	☆	☆	☆	☆	☆
	2560m (only for 1 path) (1024Kbyte)	☆	☆	☆	☆	☆	—	—
	5120m (only for 1 path) (2048Kbyte)	☆	☆	—	—	—	—	—
Number of registerable programs	63	○	○	○	○	○	○	○
	125	☆	☆	☆	☆	☆	☆	☆
	200	☆	☆	☆	☆	☆	☆	☆
	400	☆	☆	☆	☆	☆	☆	—
	1000	☆	☆	☆	☆	☆	—	—
Part program editing		○	○	○	○	○	○	○
Program protect		○	○	○	○	○	○	○
Program Encryption		☆	☆	☆	☆	☆	—	—
Background editing		☆	☆	☆	☆	☆	☆	☆
Extended part program editing		☆	☆	☆	☆	☆	☆	☆
Program copy between 2-path	Only for 2 path	*	*	—	—	*	—	—
Playback		☆	☆	☆	☆	☆	☆	☆
Machining time stamp		☆	☆	☆	☆	☆	—	—

Setting and display

Status display		○	○	○	○	○	○	○
Clock function		○	○	○	○	○	○	○
Current position display		○	○	○	○	○	○	○
Program display	Program name 31 characters	○	○	○	○	○	○	○
Parameter setting and display		○	○	○	○	○	○	○
Self-diagnosis function		○	○	○	○	○	○	○
Alarm display		○	○	○	○	○	○	○
Alarm history display		○	○	○	○	○	○	○

Note) The items marked with *1 to *16 (including such as *1-1, *1-2, and *2-1) have notes added. These notes are provided at the end of this table.

Item	Specifications	Series 16i Series 160i Series 160is		Series 18i Series 180i Series 180is			Series 21i Series 210i Series 210is	
		MB	TB	MB5	MB	TB	MB	TB
Operator message history display		*	*	*	*	*	*	*
Operation history display		○	○	○	○	○	○	○
Help function		○	○	○	○	○	○	○
FACTOLINK	*1	☆	☆	☆	☆	☆	☆	☆
Remote diagnostic	<ul style="list-style-type: none"> • Host software+Modem or • Machine remote diagnosis package+Ethernet (Function:Reading CNC/PMC status, etc.) *1	*	*	*	*	*	*	*
Run hour and parts count display		☆	☆	☆	☆	☆	☆	☆
Actual cutting feedrate display		○	○	○	○	○	○	○
Display of spindle speed and T code at all screens		*	○	*	*	○	*	○
Directory display of floppy cassette		☆	☆	☆	☆	☆	☆	☆
Directory display and punch for each group		○	○	○	○	○	○	○
Graphic function		☆	☆	☆	☆	☆	☆	☆
Dynamic graphic display		☆	*	☆	☆	*	☆	*
Background graphic (without CAP)		☆	—	☆	☆	—	—	—
Optional path name display	Only for 2 path	○	○	—	—	○	—	—
Operating monitor screen	Load meter etc.	○	○	○	○	○	○	○
Servo setting screen		○	○	○	○	○	○	○
Spindle setting screen	Only for α/α series	*	*	*	*	*	*	*
Servo waveform display	Graphic display circuit is required.	*	*	*	*	*	*	*
SERVO GUIDE Mate		☆	☆	☆	☆	☆	☆	☆
Display of hardware and software configuration		○	○	○	○	○	○	○
Servo information screen		○	○	○	○	○	○	○
Spindle information screen	Only for α/α series	*	*	*	*	*	*	*
Periodic maintenance screen		○	○	○	○	○	○	○
Maintenance information screen		○	○	○	○	○	○	○
Trouble diagnosis		○	○	○	○	○	○	○
Machine alarm diagnosis		☆	☆	☆	☆	☆	☆	☆
Software operator's panel		☆	☆	☆	☆	☆	☆	☆
Software operator's panel general purpose switch	Software operator's panel is required.	☆	☆	☆	☆	☆	☆	☆
Software operator's panel general purpose switch expansion	Software operator's panel general purpose switch is required.	☆	☆	☆	☆	☆	—	—
External touch panel interface	It is impossible to use with the Touch panel	☆	☆	☆	☆	☆	☆	☆
Virtual MDI Key for display link	Touch panel is required. *1-3	☆	☆	☆	☆	☆	☆	☆
FANUC PICTURE function		☆	☆	☆	☆	☆	☆	☆

Note) The items marked with *1 to *16 (including such as *1-1, *1-2, and *2-1) have notes added. These notes are provided at the end of this table.

Item	Specifications	Series 16i Series 160i Series 160is		Series 18i Series 180i Series 180is			Series 21i Series 210i Series 210is	
		MB	TB	MB5	MB	TB	MB	TB
Multi-language display	English	○	○	○	○	○	○	○
	Japanese (Chinese character)	☆	☆	☆	☆	☆	☆	☆
	German/French	☆	☆	☆	☆	☆	☆	☆
	Italian	☆	☆	☆	☆	☆	☆	☆
	Chinese	☆	☆	☆	☆	☆	☆	☆
	Spanish	☆	☆	☆	☆	☆	☆	☆
	Korean	☆	☆	☆	☆	☆	☆	☆
	Portuguese	☆	☆	☆	☆	☆	☆	☆
	Polish	☆	☆	☆	☆	☆	☆	☆
	Hungarian	☆	☆	☆	☆	☆	☆	☆
	Swedish	☆	☆	☆	☆	☆	☆	☆
	Czech	☆	☆	☆	☆	☆	☆	☆
Dutch	☆	—	☆	☆	—	☆	—	
Data protection key	4 types	○	○	○	○	○	○	○
Erase CRT screen display	Manual or Automatic *1	○	○	○	○	○	○	○
Parameter set supporting screen		○	○	○	○	○	○	○
Machining condition selecting screen	Advanced preview control or AI contour control and so on is required.	☆	☆	☆	☆	☆	☆	☆

Data input/output

Reader/puncher interface	Reader/puncher (Ch.1) interface	☆	☆	☆	☆	☆	☆	☆
	Reader/puncher (Ch.2) interface	☆	☆	☆	☆	☆	☆	☆
Input/output simultaneous operation	Only for 1 path	☆	—	☆	☆	—	—	—
Remote buffer	Only for 1 path	☆	☆	☆	☆	☆	☆	☆
High-speed remote buffer A	Only for 1 path	☆	☆	☆	☆	☆	☆	☆
High-speed remote buffer B	Only for 1 path	☆	—	☆	☆	—	☆	—
Data server	Only for 1 path *1	☆	☆	☆	☆	☆	☆	☆
External I/O device control		☆	☆	☆	☆	☆	☆	☆
DNC1 control	Uploading/downloading a part program, Reading/writing CNC data, Transfer of PMC data, Memory operation control, etc.	☆	☆	☆	☆	☆	☆	☆
DNC2 control	Only for 1 path Uploading/downloading a part program, Reading/writing CNC data, Transfer of PMC data, Memory operation control, etc.	☆	☆	☆	☆	☆	☆	☆
Modem card control	*1	○	○	○	○	○	○	○
External tool offset		☆	☆	☆	☆	☆	☆	☆
External message		☆	☆	☆	☆	☆	☆	☆
External machine zero point shift		☆	☆	☆	☆	☆	☆	☆
External data input	Including above 3 items	☆	☆	☆	☆	☆	☆	☆
External key input		○	○	○	○	○	○	○
External program input		○	○	○	○	○	○	○
External workpiece number search	9999	○	○	○	○	○	○	○
External program number search	1 to 9999	*	*	*	*	*	*	*

Note) The items marked with *1 to *16 (including such as *1-1, *1-2, and *2-1) have notes added. These notes are provided at the end of this table.

Item	Specifications	Series 16i Series 160i Series 160is		Series 18i Series 180i Series 180is			Series 21i Series 210i Series 210is	
		MB	TB	MB5	MB	TB	MB	TB
One touch macro call		☆	☆	☆	☆	☆	☆	☆
Memory card input/output		○	○	○	○	○	○	○
Screen hard copy	*1-2	○	○	○	○	○	○	○
Power Mate CNC manager		☆	☆	☆	☆	☆	☆	☆

Interface function

Embedded Ethernet		○	○	○	○	○	☆	☆
Ethernet	Ethernet board is required.	☆	☆	☆	☆	☆	☆	☆
Fast Ethernet	Fast Ethernet board is required.	☆	☆	☆	☆	☆	☆	☆
I/O Link-II	Master/Slave	☆	☆	☆	☆	☆	☆	☆
PROFIBUS-DP	Master/Slave	☆	☆	☆	☆	☆	☆	☆
DeviceNet	Master/Slave	☆	☆	☆	☆	☆	☆	☆
FL-net	Only for stand-alone type	☆	☆	☆	☆	☆	☆	☆

Others

Status output signal	NC ready, servo ready, automatic operation, automatic operation start lamp, feed hold, reset, NC alarm, distribution end, rewinding, inch input, cutting, inposition, thread cutting, tapping, etc.	○	○	○	○	○	○	○
Control unit incorporated type display unit *10 *11 (Not available in 160i/180i/210i)	7.2" monochrome LCD *1-1	●	●	●	●	●	●	●
	9.5" monochrome LCD *1-1	●	●	●	●	●	●	●
	8.4" color LCD *1-1	●	●	●	●	●	●	●
	10.4" color LCD	●	●	●	●	●	●	●
Control unit dimensions for LCD unit mounted type (depth)	Without option slots (depth 60mm)	●	●	●	●	●	●	●
	Option 2 slots (depth 110mm)	●	●	●	●	●	●	●
	Option 3 slots (depth 125mm)	●	●	●	●	●	—	—
	Option 4 slots (depth 170mm)	●	●	●	●	●	—	—
Display unit for stand-alone type control unit *10 *12	7.2" monochrome LCD (Display Link type) *1	●	●	●	●	●	●	●
	9.5" monochrome LCD *1	●	●	●	●	●	●	●
	10.4" color LCD	●	●	●	●	●	●	●
Control unit dimensions for stand-alone type control unit (width)	1 slot (Width 60mm)	●	●	●	●	●	●	●
	3 slots (Width 172mm)	●	●	●	●	●	●	●
MDI unit	Separate MDI (small size) *1	●	●	●	●	●	●	●
	Separate MDI (standard size, horizontal/vertical type)	●	●	●	●	●	●	●
	Separate MDI (61key, horizontal/vertical type)	●	●	●	●	●	●	●
	Separate MDI (personal computer key, vertical type) *2-1	●	●	●	●	●	●	●
Touch panel	Only for 10.4" LCD *11*12	●	●	●	●	●	●	●

Note) The items marked with *1 to *16 (including such as *1-1, *1-2, and *2-1) have notes added. These notes are provided at the end of this table.

Item		Specifications	Series 16i Series 160i Series 160is		Series 18i Series 180i Series 180is			Series 21i Series 210i Series 210is	
			MB	TB	MB5	MB	TB	MB	TB
PMC SYSTEM	PMC-SA1	Basic instruction: 5μsec/step Max. step number ladder: 5000	—	—	—	—	—	●	●
	PMC-SB7	Basic instruction: 0.033μsec/step Max. step number ladder: 64000	●	●	●	●	●	●	●
		Step sequence function	☆	☆	☆	☆	☆	☆	☆
	C language	Max. 2MB (PMC-SB7 is required)	☆	☆	☆	☆	☆	☆	☆
		Nonvolatile memory expansion	☆	☆	☆	☆	☆	☆	☆
I/O Link expansion	DI/DO points: 2048/2048 points (PMC-SB7 is required)	☆	☆	☆	☆	☆	☆	☆	
Standard operator's panel			☆	☆	☆	☆	☆	☆	☆
Machine interface (I/O Link) Max. DI/DO points: 1024/1024 points or 2048/2048 points (Note) If using 2048/2048 points, I/O Link expansion option is necessary.	I/O Unit-MODEL A		●	●	●	●	●	●	●
	I/O Unit-MODEL B		●	●	●	●	●	●	●
	Operator's panel I/O module		●	●	●	●	●	●	●
	Power magnetics control I/O module		●	●	●	●	●	●	●
	Connection panel I/O module (DI/DO module, 2A output module, Analog input module)		●	●	●	●	●	●	●
I/O Link – AS-i converter			☆	☆	☆	☆	☆	☆	☆
Manula pulse generator			☆	☆	☆	☆	☆	☆	☆
Pendant type manual pulse generator		With axis selection and magnification switches	☆	☆	☆	☆	☆	☆	☆
Codeless manual pulse generator		Restricted use in Japan	☆	☆	☆	☆	☆	☆	☆
Handy machine operator's panel			☆	☆	☆	☆	☆	☆	☆
Connectable servo motor		FANUC AC servo motor <i>αi</i> series, <i>αi</i> series, <i>α</i> series, <i>β</i> series	○	○	○	○	○	○	○
Connectable servo amplifier		FANUC servo amplifier <i>αi</i> series, <i>α</i> series, <i>β</i> series	○	○	○	○	○	○	○
Position detector unit for full-closed control (for full-closed control)	Pulse coder/optical scale (2-phase pulse interface)		☆	☆	☆	☆	☆	☆	☆
	Pulse coder/optical scale (serial interface)		☆	☆	☆	☆	☆	☆	☆
Connectable spindle motor		FANUC AC spindle motor <i>αi</i> series, <i>α</i> series, etc.	○	○	○	○	○	○	○
Connectable spindle amplifier	FANUC servo amplifier <i>αi</i> series, <i>α</i> series		☆	☆	☆	☆	☆	☆	☆
	Analog interface		☆	☆	☆	☆	☆	☆	☆
Input power supply		DC24V±10%	●	●	●	●	●	●	●
Ambient temperature of unit *12	LCD mounted type control unit, display unit for stand-alone type control unit At operating: 0°C to 58°C At nonoperating: -20°C to 60°C		●	●	●	●	●	●	●
	Stand alone type control unit At operating: 0°C to 55°C At nonoperating: -20°C to 60°C		●	●	●	●	●	●	●

Note) The items marked with *1 to *16 (including such as *1-1, *1-2, and *2-1) have notes added. These notes are provided at the end of this table.

Item	Specifications	Series 16i Series 160i Series 160is		Series 18i Series 180i Series 180is			Series 21i Series 210i Series 210is	
		MB	TB	MB5	MB	TB	MB	TB
Ambient relative humidity *12	Normally: 75%RH or less (No dew, nor frost allowed) Short term (within one month): 95%RH or less (No dew, nor frost allowed)	○	○	○	○	○	○	○
Vibration	At operating: 0.5G or less At nonoperating: 1G or less	○	○	○	○	○	○	○

Note) The items marked with *1 to *16 (including such as *1-1, *1-2, and *2-1) have notes added. These notes are provided at the end of this table.

Software of personal computer part in case of the CNC system which is 160i/180i/210i or connected with personal computer via HSSB (High Speed Serial Bus)

Items	Specifications	Remarks
Operating system	Windows® 2000/XP *6	
Extended library	FOCAS2 *9	
Software packages	CNC basic operation package	Option
	Milling animation function	Option
	CNC screen display function	Option
	Ladder editing package	Option
	DNC operation management package	Option
	Machining status monitor package	Option
Development tools	Visual C++® *6	Microsoft Corp.
	Visual Basic® *6	Microsoft Corp.

Note) The items marked with *1 to *16 (including such as *1-1, *1-2, and *2-1) have notes added. These notes are provided at the end of this table.

Software of GUI part in case of the CNC system which is 160is/180is/210is

(GUI = Graphical User Interface)

Items	Specifications	Remarks
Operating system	Windows® CE 3.0 *6	
Extended library	FOCAS1 *9	
Software packages	CNC screen display function	
Development tools	eMbedded™ Visual Tools 3.0 *6	Microsoft Corp.

Note) The items marked with *1 to *16 (including such as *1-1, *1-2, and *2-1) have notes added. These notes are provided at the end of this table.

Hardware of Windows® CE GUI part of incorporated type 160is/180is/210is(GUI = Graphical User Interface)

Items	Specifications	Remarks
CPU	HITACHI SH-4	
Main memory	64MBytes	
File memory	CompactFlash™ card *6	Built-in
Monitor	10.4" color TFT LCD (with touch panel) 640 × 480 dots	*10
	12.1" color TFT LCD 800 × 600 dots	
	Touch panel	Option
Ports	PCMCIA × 1 slot Ethernet (100BASE-TX) USB × 1	
Ambient temperature of unit	At operating: 0°C to 58°C At nonoperating: -20°C to 60°C	
Ambient relative humidity	Normally: 10% to 75% RH or less Short term (within one month): 10% to 90% RH or less (No dew, nor frost allowed)	

Note) The items marked with *1 to *16 (including such as *1-1, *1-2, and *2-1) have notes added. These notes are provided at the end of this table.

Hardware of HSSB (High Speed Serial Bus) and Required hardware of commercially available personal computer in case of the CNC system which is connected with the personal computer via HSSB (High Speed Serial Bus).

Items	Specifications	Remarks
CNC side interface board	Display unit incorporated type for option slot Display unit separate type for option slot	
Personal computer side interface board	ISA Bus and HSSB for 1 channel	For ISA slot in the personal computer Using voltage: +5V only
	ISA Bus and HSSB for 2 channel	
	PCI Bus and HSSB for 1 channel	For PCI slot in the personal computer Using voltage: +5V only
	PCI Bus and HSSB for 2 channel	
Connecting cable	Optical fiber cable	Max. length: 100m
Personal computer requirements	CPU: Pentium® or more ISA slot or PCI slot 1 or more (By selectable personal computer side interface board)	For environmental requirements of the personal computer, refer to the manual supplied with the machine.

Note) The items marked with *1 to *16 (including such as *1-1, *1-2, and *2-1) have notes added. These notes are provided at the end of this table.

Hardware of PANEL *i* used in 160*i*/180*i*/210*i*

Items	Specifications	Remarks
CPU	Pentium® III, Celeron™ *6	
Main memory	Max. 512MBytes	
Hard disk	40GBytes	
Monitor	10.4" color TFT LCD (640 × 480 dots), or 12.1" color TFT LCD (800 × 600 dots), or 15.0" color TFT LCD (1024 × 768 dots)	Display Max. 65536 colors Several models limited to Max. 4096 colors *7 *10
	Touch panel	Option
Ports	PCMCIA × 1 slot Full keyboard × 1/Mouse × 1 Serial (RS-232C) × 2/Parallel × 1 Floppy disk × 1 Ethernet (100BASE-TX) USB × 2	Touch panel is connected to serial port 1.
CNC interface	High-Speed Serial Bus (Optical fiber cable)	Max. length: 100m
Extension slot	PCI spec. extension slot (Short card size) × 2	*8
Ambient temperature of unit	At operating: 5°C to 45°C At nonoperating: -20°C to 60°C	
Ambient relative humidity	Normally: 10% to 75% RH or less Short term (within one month): 10% to 90% RH or less (No dew, nor frost allowed) Wet Humidity: 29°C or less	

Note) The items marked with *1 to *16 (including such as *1-1, *1-2, and *2-1) have notes added. These notes are provided at the end of this table.

Hardware of Display Unit for *is* series CNC used in 160*is*/180*is*/210*is*

Items	Specifications	Remarks
CPU	HITACHI SH-4	
Main memory	64MBytes	
File memory	CompactFlash™ card *6	Built-in
Monitor	10.4" color TFT LCD (with touch panel) 640 × 480 dots	*10
	12.1" color TFT LCD 800 × 600 dots	
	Touch panel	Option
Ports	PCMCIA × 1 slot Ethernet (100BASE-TX) USB × 1	

Note) The items marked with *1 to *16 (including such as *1-1, *1-2, and *2-1) have notes added. These notes are provided at the end of this table.

Items	Specifications	Remarks
Ambient temperature of unit	At operating: 0°C to 58°C At nonoperating: -20°C to 60°C	
Ambient relative humidity	Normally: 10% to 75% RH or less Short term (within one month): 10% to 90% RH or less (No dew, nor frost allowed)	

Note) The items marked with *1 to *16 (including such as *1-1, *1-2, and *2-1) have notes added. These notes are provided at the end of this table.

NOTE

*1 : There are some limitations in case of 160*i*/180*i*/210*i*/160*is*/180*is*/210*is*.

*1-1 : In case of 160*is*/180*is*/210*is*, this function can not be used.

*1-2 : This function can not be used in the following case :

- 160*i*/180*i*/210*i*/160*is*/180*is*/210*is*
- Construction of connecting with Personal Computer via HSSB and not attaching MDI to CNC side.

*1-3 : In case of 160*i*/180*i*/210*i*/160*is*/180*is*/210*is*, this function can not be used.

*2 : Only for 160*i*/180*i*/210*i*.

*2-1 : Only for 160*i*/160*is*/180*i*/180*is*/210*i*/210*is*.

*3 : In case of using 1 CPU 2 path for 18*i*, total 3 axes are available at 2 path.

*4 : In case of 16*i*/18*i*, 1 path is Max. 6MB, 2 path is Max. 4MB, 21*i* is Max. 4MB.

*5 : The actual registrable value might changes according to the registered number of programs and the program sizes.

*6 : Intel, Pentium are registered trademarks of Intel Corporation. Celeron is the trademark of Intel Corporation.

Microsoft, Windows, Visual C++, Visual Basic and eMbedded Visual Tools logo are registered trademarks of Microsoft Corporation. CompactFlash is registered trademark of SanDisk Corporation.

Each company's name and product's name is the trademark or registered trademark.

*7 : A special driver is necessary to display 16 or more colors.

*8 : Extension Board for IBM PC should be prepared by MTB.

*9 : FOCAS1/2 = FANUC Open Cnc API Specifications version 1/2

*10 : LCD is manufactured by using high precision technology, however it has points which are always bright or dark.

This phenomenon is caused by LCD's structure, and not defects.

*11 : Please refer to Chapter II-35 for hardware of LCD-mounted type 160*is*/180*is*/210*is*

*12 : Please refer to Chapter II-35 for PANEL *i* used in 160*i*/180*i*/210*i* and Hardware of Display Unit for *is* series CNC used in 160*is*/180*is*/210*is*

*13 : In case of T series, it is possible to use this function on 1st path only.

*14 : In case of T series, AI high-precision contour control or AI nano high-precision contour control is required.

*15 : It is possible to use this function on 1st path only.

*16 : Any of following functions is required.

High-precision contour control/AI high-precision contour control/AI nano high-precision contour control

II. NC FUNCTION

PREFACE



This part describes the functions that can be performed on all models. For the functions available with each model, see the list of specifications in Part I.

For information about the Series 20*i*, see also Part IV.

1

CONTROLLED AXES



1.1 NUMBER OF THE ALL CONTROLLED AXES

The number of all controlled axes is the sum of the number of machine controlled axes and the number of loader controlled axes. The machine controlled axes include Cs axis.

16i-MB/16i-TB/160i-MB/160i-TB/160is-MB/160is-TB (1-path) :

18i-MB5/18i-MB/18i-TB/180i-MB5/180i-MB/180i-TB/

180is-MB5/180is-MB/180is-TB (1-path) :

12 axes (8 machine axes+4 loader axes)

16i-TB/160i-TB/160is-TB (2-path with 1 CPU) :

18i-TB/180i-TB/180is-TB (2-path with 1 CPU) :

12 axes (4 machine axes × 2-path+4 loader axes)

16i-MB/16i-TB/160i-MB/160i-TB/160is-MB/160is-TB

(2-path with 2 CPU) :

18i-TB/180i-TB/180is-TB (2-path with 2 CPU) :

20 axes (8 machine axes × 2-path+4 loader axes)

16i-TB/160i-TB/160is-TB (3-path) :

16 axes (8 machine axes × 1-path+4 axes × 2-path)

21i-MB/210i-MB/210is-MB : 5 axes (5 machine axes)

21i-TB/210i-TB/210is-TB : 9 axes (5 machine axes+4 loader axes)

20i-FB: 4 axes (4 machine axes)

20i-TB: 2 axes (2 machine axes)

1.2.5 Number of Simultaneously Controlled Axes Expanded (All)

16i-MB/16i-TB/160i-MB/160i-TB/160is-MB/160is-TB (each path) :
Max. 6 axes
18i-MB5/180i-MB5/180is-MB5/180is-TB :
Max. 5 axes
18i-MB/18i-TB/180i-MB/180i-TB/180is-MB/180is-TB (each path) :
Max. 4 axes
21i-MB/21i-TB/210i-MB/210i-TB/210is-MB/210is-TB/20i-FB :
Max. 4 axes

1.2.6 Axis Control by PMC

16i-MB/16i-TB/18i-MB5//18i-MB/18i-TB/21i-MB/21i-TB/160i-MB/
160i-TB/160is-MB/160i-TB/180i-MB/180i-TB/180is-MB5/180is-MB/
180is-TB/210i-MB/210i-TB/210is-MB/210is-TB/20i-FB (each path) :
Max. simultaneous 4 axes (Cs axis is disable.)

1.2.7 Cs Contour Control

16i-MB/160i-MB/160is-MB/16i-TB/160i-TB/160is-TB (at 1-path) :
Up to 4 axes
18i-MB/180i-MB/180is-MB/18i-TB/180i-TB/180is-TB (at 1-path) :
Up to 3 axes
21i-MB/210i-MB/210is-MB/21i-TB/210i-TB/210is-TB (at 1-path) :
Up to 2 axes
16i-MB/160i-MB/160is-MB/16i-TB/160i-TB/160is-TB
(at 2CPU 2-path) : Up to 4 axes for each path
18i-TB/180i-TB/180is-TB (at 2CPU 2-path): Up to 3 axes for each path
16i-TB/160i-TB/160is-TB/18i-TB/180i-TB/180is-TB
(at 1CPU 2-path) : Up to 2 axes for each path
(For 1CPU 2-path on the 18i/180i/180is, up to 3 axes are permitted for
both paths in total.)
16i-TB/160i-TB/160is-TB (at 2CPU 3-path) : Up to 2 axes for each path

1.3 LOADER CONTROLLED AXES

Number of controlled paths	: 1-path
Number of controlled axes	: Max. 4 axes
Number of simultaneously controlled axes	: Max. 4 axes
Number of controlled axes by PMC	: Max. 4 axes

1.4 AXIS NAMES

T series :

The two basic axes are always set to X and Z. Additional axes can be selected from A, B, C, U, V, W, and Y freely. For the 2-path control, the two basic axes are always set to X and Z on each path, and additional axes can be selected freely from A, B, C, U, V, W, and Y.

NOTE

If U, V, or W is used as an axis name, the G code system must be either B or C.

M series :

The three basic axes are set to X, Y, and Z. Additional axes can be selected from A, B, C, U, V, and W freely.

For two-path control, X, Y, and Z are always used as the names of the three basic axes. Additional axes can be assigned any of A, B, C, U, V, and W as their names.

1.5 INCREMENT SYSTEM

There are three increment systems as shown in the tables below. One of the increment systems can be selected using a parameter.

NOTE
 If IS-C is selected, option "increment system 1/10" is required.
 If IS-D is selected, option "increment system 1/100" is required.

Table 1.5(a) IS-B

		Least input increment	Least command increment	Abbreviation
Millimeter machine	Metric input	0.001 mm (diameter programming)	0.0005 mm	IS-B
		0.001 mm (radius programming)	0.001 mm	
		0.001 deg	0.001 deg	
	Inch input	0.0001 inch (diameter programming)	0.0005 mm	
		0.0001 inch (radius programming)	0.001 mm	
		0.001 deg	0.001 deg	
Inch machine	Metric input	0.001 mm (diameter programming)	0.00005 inch	
		0.001 mm (radius programming)	0.0001 inch	
		0.001 deg	0.001 deg	
	Inch input	0.0001 inch (diameter programming)	0.00005 inch	
		0.0001 inch (radius programming)	0.0001 inch	
		0.001 deg	0.001 deg	

Table 1.5(b) IS-C

		Least input increment	Least command increment	Abbreviation
Millimeter machine	Metric input	0.0001 mm (diameter programming)	0.00005 mm	IS-C
		0.0001 mm (radius programming)	0.0001 mm	
		0.0001 deg	0.0001 deg	
	Inch input	0.00001 inch (diameter programming)	0.00005 mm	
		0.00001 inch (radius programming)	0.0001 mm	
		0.0001 deg	0.0001 deg	
Inch machine	Metric input	0.0001 mm (diameter programming)	0.000005 inch	
		0.0001 mm (radius programming)	0.00001 inch	
		0.0001 deg	0.0001 deg	
	Inch input	0.00001 inch (diameter programming)	0.000005 inch	
		0.00001 inch (radius programming)	0.00001 inch	
		0.0001 deg	0.0001 deg	

Table 1.5(c) IS-D

		Least input increment	Least command increment	Abbreviation
Millimeter machine	Metric input	0.00001 mm (diameter programming)	0.000005 mm	IS-D
		0.00001 mm (radius programming)	0.00001 mm	
		0.00001 deg	0.00001 deg	
	Inch input	0.000001 inch (diameter programming)	0.000005 mm	
		0.000001 inch (radius programming)	0.00001 mm	
		0.00001 deg	0.00001 deg	
Inch machine	Metric input	0.00001 mm (diameter programming)	0.0000005 inch	
		0.00001 mm (radius programming)	0.000001 inch	
		0.00001 deg	0.00001 deg	
	Inch input	0.000001 inch (diameter programming)	0.0000005 inch	
		0.000001 inch (radius programming)	0.000001 inch	
		0.00001 deg	0.00001 deg	

The least command increment is in millimeters or inches, depending on the machine tool. One of them must be selected using a parameter beforehand.

The least input increment can be switched between metric input and inch input by using a G code (G20 or G21) or a setting parameter.

1.5.1 Input Unit (10 Times)

The following least input increments can be set using a parameter:

Increment system	Least input increment
IS-B	0.01 mm, 0.01 deg, or 0.0001 inch
IS-C	0.001 mm, 0.001 deg, or 0.00001 deg

NOTE

The minimum input increment for inch input is not affected.

1.6 MAXIMUM STROKE

The following table lists the maximum strokes of machine tools that are allowed by the control unit:

$$\text{Maximum stroke} = \text{Least command increment} \times 99999999$$

Increment system		Maximum stroke
IS-B	Millimeter machine	±99999.999 mm ±99999.999 deg
	Inch machine	±9999.9999 inch ±99999.999 deg
IS-C	Millimeter machine	±9999.9999 mm ±9999.9999 deg
	Inch machine	±999.99999 inch ±9999.9999 deg

NOTE

- 1 The values (in mm or inches) in the table are diameter values if diameter programming is specified, or radius values if radius programming is specified.
- 2 A command that exceeds the maximum stroke is not allowed.

2 PREPARATORY FUNCTIONS



2.1 T SERIES

The following G codes are provided. The G codes are classified into three: A, B, and C. One of the G code types can be selected using a parameter. In this manual, G code system B is assumed.

G code list for T series (1/3)

G code			Group	Function
A	B	C		
G00	G00	G00	01	Positioning (Rapid traverse)
G01	G01	G01		Linear interpolation (Cutting feed)
G02	G02	G02		Circular interpolation CW
G03	G03	G03		Circular interpolation CCW
G04	G04	G04	00	Dwell
G05	G05	G05		High speed cycle cutting, high-speed remote buffer A
G07	G07	G07		Hypothetical axis interpolation
G07.1 (G107)	G07.1 (G107)	G07.1 (G107)		Cylindrical interpolation
G08	G08	G08		Advanced preview control
G10	G10	G10		Programmable data input
G10.6	G10.6	G10.6		Tool retract and return
G11	G11	G11		Programmable data input mode cancel
G12.1 (G112)	G12.1 (G112)	G12.1 (G112)	21	Polar coordinate interpolation mode
G13.1 (G113)	G13.1 (G113)	G13.1 (G113)		Polar coordinate interpolation cancel mode
G17	G17	G17	16	XpYp plane selection
G18	G18	G18		ZpXp plane selection
G19	G19	G19		YpZp plane selection
G20	G20	G70	06	Input in inch
G21	G21	G71		Input in mm
G22	G22	G22	09	Stored stroke check function on
G23	G23	G23		Stored stroke check function off
G25	G25	G25	08	Spindle speed fluctuation detection off
G26	G26	G26		Spindle speed fluctuation detection on
G27	G27	G27	00	Reference position return check
G28	G28	G28		Return to reference position
G30	G30	G30		2nd, 3rd and 4th reference position return
G30.1	G30.1	G30.1		Floating reference point return
G31	G31	G31		Skip function

G code list for T series (2/3)

G code			Group	Function
A	B	C		
G32	G33	G33	01	Thread cutting
G34	G34	G34		Variable-lead thread cutting
G35	G35	G35		Circular threading CW
G36	G36	G36		Circular threading CCW (When the bit 3 (G36) of parameter No. 3405 is set to 1)
G36	G36	G36	00	Automatic tool compensation X (When the bit 3 (G36) of parameter No. 3405 is set to 0)
G37	G37	G37		Automatic tool compensation Z
G37.1	G37.1	G37.1		Automatic tool compensation X
G37.2	G37.2	G37.2		Automatic tool compensation Z
G39	G39	G39		Corner circular interpolation
G40	G40	G40	07	Tool nose radius compensation cancel
G41	G41	G41		Tool nose radius compensation left
G42	G42	G42		Tool nose radius compensation right
G50	G92	G92	00	Coordinate system setting or max. spindle speed setting
G50.3	G92.1	G92.1		Workpiece coordinate system preset
G50.2 (G250)	G50.2 (G250)	G50.2 (G250)	20	Polygonal turning cancel
G51.2 (G251)	G51.2 (G251)	G51.2 (G251)		Polygonal turning
G52	G52	G52	00	Local coordinate system setting
G53	G53	G53		Machine coordinate system setting
G54	G54	G54	14	Workpiece coordinate system 1 selection
G55	G55	G55		Workpiece coordinate system 2 selection
G56	G56	G56		Workpiece coordinate system 3 selection
G57	G57	G57		Workpiece coordinate system 4 selection
G58	G58	G58		Workpiece coordinate system 5 selection
G59	G59	G59		Workpiece coordinate system 6 selection
G60	G60	G60	00	Single direction positioning
G65	G65	G65		Macro calling
G66	G66	G66	12	Macro modal call
G67	G67	G67		Macro modal call cancel
G68	G68	G68	04	Mirror image for double turrets ON or balance cut mode
G68.1	G68.1	G68.1	17	Three-dimensional coordinate system conversion mode on
G69	G69	G69	04	Mirror image for double turrets OFF or balance cut mode cancel
G69.1	G69.1	G69.1	17	Three-dimensional coordinate system conversion mode off

G code list for T series (3/3)

G code			Group	Function
A	B	C		
G70	G70	G72	00	Finishing cycle
G71	G71	G73		Stock removal in turning
G72	G72	G74		Stock removal in facing
G73	G73	G75		Pattern repeating
G74	G74	G76		End face peck drilling
G75	G75	G77		Outer diameter/internal diameter drilling
G76	G76	G78		Multiple threading cycle
G71	G71	G72	01	Traverse grinding cycle (for grinding machine)
G72	G72	G73		Traverse direct constant-dimension grinding cycle (for grinding machine)
G73	G73	G74		Oscillation grinding cycle (for grinding machine)
G74	G74	G75		Oscillation direct constant-dimension grinding cycle (for grinding machine)
G80	G80	G80	10	Canned cycle for drilling cancel
G80.4	G80.4	G80.4	00	Hobbing function synchronous cancel
G81.4	G81.4	G81.4		Hobbing function synchronous start
G83	G83	G83	10	Cycle for face drilling
G84	G84	G84		Cycle for face tapping
G86	G86	G86		Cycle for face boring
G87	G87	G87		Cycle for side drilling
G88	G88	G88		Cycle for side tapping
G89	G89	G89		Cycle for side boring
G90	G77	G20	01	Outer diameter/internal diameter cutting cycle
G92	G78	G21		Thread cutting cycle
G94	G79	G24		Endface turning cycle
G96	G96	G96	02	Constant surface speed control
G97	G97	G97		Constant surface speed control cancel
G98	G94	G94	05	Per minute feed
G99	G95	G95		Per rotation feed
–	G90	G90	03	Absolute programming
–	G91	G91		Incremental programming
–	G98	G98	11	Return to initial level
–	G99	G99		Return to R point level
G100	G100	G100	00	B axis control-Program registration completion
G101	G101	G101		B axis control-First program registration start
G102	G102	G102		B axis control-Second program registration start
G103	G103	G103		B axis control-Third program registration start
G110	G110	G110		B axis control-One motion operation programming

2.2 M SERIES

The following G codes are provided :

G code list for M series (1/4)

G code	Group	Function	
G00	01	Positioning	
G01		Linear interpolation	
G02		Circular interpolation/Helical interpolation CW	
G03		Circular interpolation/Helical interpolation CCW	
G02.2, G03.2		Involute interpolation	
G02.3, G03.3		Exponential function interpolation	
G02.4, G03.4		Three-dimensional circular interpolation	
G04	00	Dwell, Exact stop	
G05		High speed cycle machining, high-speed remote buffer A/B, high-precision contour control, simple high-precision contour control	
G05.1		AI contour/AI nano contour/AI advanced preview/Smooth interpolation	
G05.4		HRV3 on/off	
G06.2	01	NURBS interpolation	
G07	00	Hypothetical axis interpolation	
G07.1 (G107)		Cylindrical interpolation	
G08		Look-ahead control	
G09		Exact stop	
G10		Programmable data input	
G10.6		Tool retract and return	
G11	Programmable data input mode cancel		
G12.1	25	Polar coordinate interpolation mode	
G13.1		Polar coordinate interpolation cancel mode	
G15	17	Polar coordinates command cancel	
G16		Polar coordinates command	
G17	02	XpYp plane selection	Xp: X axis or its parallel axis
G18		ZpXp plane selection	Yp: Y axis or its parallel axis
G19		YpZp plane selection	Zp: Z axis or its parallel axis
G20	06	Input in inch	
G21		Input in mm	
G22	04	Stored stroke check function on	
G23		Stored stroke check function off	
G25	24	Spindle speed fluctuation detection off	
G26		Spindle speed fluctuation detection on	

G code list for M series (2/4)

G code	Group	Function
G27	00	Reference position return check
G28		Automatic return to reference position
G29		Automatic return from reference position
G30		2nd, 3rd and 4th reference position return
G30.1		Floating reference point return
G31		Skip function
G31.8		EGB skip function
G31.9		Continuous high-speed skip function
G33	01	Thread cutting
G37	00	Automatic tool length measurement
G39		Corner offset circular interpolation
G40	07	Cutter compensation cancel/three-dimensional tool compensation cancel
G41		Cutter compensation left/three-dimensional tool compensation
G41.2		Three-dimensional cutter compensation (Tool side compensation) left side
G41.3		Three-dimensional cutter compensation (Leading edge offset)
G42		Cutter compensation right
G42.2		Three-dimensional cutter compensation (Tool side compensation) right side
G40.1 (G150)	19	Normal direction control cancel mode
G41.1 (G151)		Normal direction control left side on
G42.1 (G152)		Normal direction control right side on
G43	08	Tool length compensation + direction
G44		Tool length compensation – direction
G45	00	Tool offset increase
G46		Tool offset decrease
G47		Tool offset double increase
G48		Tool offset double decrease
G49	08	Tool length compensation cancel
G50	11	Scaling cancel
G51		Scaling
G50.1	22	Programmable mirror image cancel
G51.1		Programmable mirror image

G code list for M series (3/4)

G code	Group	Function
G52	00	Local coordinate system setting
G53		Machine coordinate system selection
G54	14	Workpiece coordinate system 1 selection
G54.1		Additional workpiece coordinate system selection
G54.2	23	Rotary table dynamic fixture offset
G55	14	Workpiece coordinate system 2 selection
G56		Workpiece coordinate system 3 selection
G57		Workpiece coordinate system 4 selection
G58		Workpiece coordinate system 5 selection
G59		Workpiece coordinate system 6 selection
G60	00/01	Single direction positioning
G61	15	Exact stop mode
G62		Automatic corner override
G63		Tapping mode
G64		Cutting mode
G65	00	Macro call
G66	12	Macro modal call
G67		Macro modal call cancel
G68	16	Coordinate rotation/three-dimensional coordinate conversion
G69		Coordinate rotation cancel/three-dimensional coordinate conversion cancel
G72.1	00	Rotation copy
G72.2		Linear copy
G73	09	Peck drilling cycle
G74		Counter tapping cycle
G75	01	Plunge grinding cycle (for grinding machine)
G76	09	Fine boring cycle
G77	01	Direct constant-dimension plunge grinding cycle(for grinding machine)
G78		Continuous-feed surface grinding cycle(for grinding machine)
G79		Intermittent-feed surface grinding cycle(for grinding machine)

G code list for M series (4/4)

G code	Group	Function
G80	09	Canned cycle cancel/external operation function cancel
G80.5	24	Synchronization start of electronic gear box (EGB) (for two axes programming)
G81	09	Drilling cycle, spot boring cycle or external operation function
G81.1	00	Chopping function
G81.5	24	Synchronization start of electronic gear box (EGB) (for two axes programming)
G82	09	Drilling cycle or counter boring cycle
G83		Peck drilling cycle
G84		Tapping cycle
G85		Boring cycle
G86		Boring cycle
G87		Back boring cycle
G88		Boring cycle
G89		Boring cycle
G90	03	Absolute command
G91		Increment command
G92	00	Setting for work coordinate system or clamp at maximum spindle speed
G92.1		Workpiece coordinate system preset
G94	05	Feed per minute
G95		Feed per rotation
G96	13	Constant surface speed control
G97		Constant surface speed control cancel
G98	10	Return to initial point in canned cycle
G99		Return to R point in canned cycle
G160	20	In-feed control function cancel(for grinding machine)
G161		In-feed control function(for grinding machine)

3

INTERPOLATION FUNCTIONS



3.1 POSITIONING (G00)

Positioning is done with each axis separately (Non linear interpolation type positioning).

Either of the following tool paths can be selected according to parameter.

- **Non linear interpolation positioning**

The tool is positioned with the rapid traverse rate for each axis separately. The tool path is normally straight.

- **Linear interpolation positioning**

The tool path is the same as in linear interpolation (G01). The tool is positioned within the shortest possible time at a speed that is not more than the rapid traverse rate for each axis.

When the acceleration/deceleration type is changed from the constant acceleration (inclination) type to the constant time (time constant) type, the tool can move along a specified path.

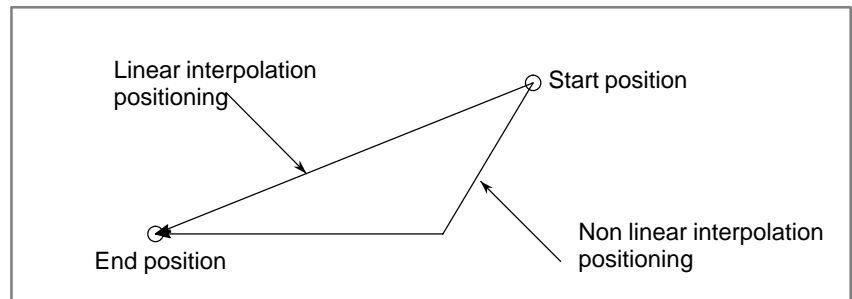

It is decelerated, to a stop at the end point, and imposition check is performed (checks whether the machine has come to the specified position). The in-position check can be suppressed using a parameter. Width of imposition can be set as a parameter.

Format

```
G00 IP_ ;
```

3.2 **M series** SINGLE DIRECTION POSITIONING (G60)

It is always controlled to perform positioning to the end point from a single direction, for better precision in positioning. If direction from start point to end point is different from the predecided direction, it once positions to a point past the end point, and the positioning is reperformed for that point to the end point.

Even if the direction from start point to end point is the same as predecided direction, the tool stops once before the end point.

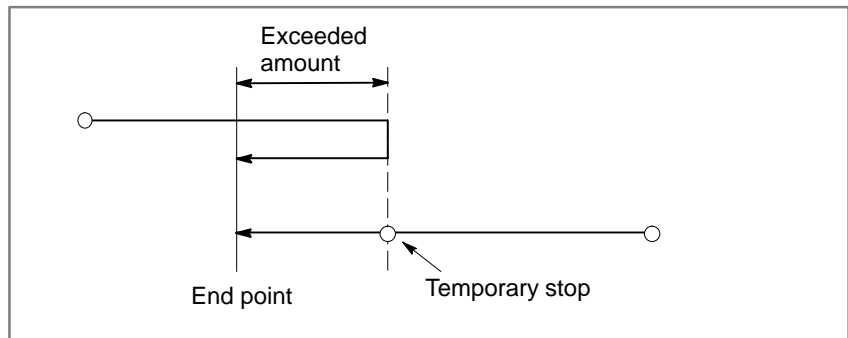

Format

G60 IP_ ;

3.3 LINEAR INTERPOLATION (G01)

Linear interpolation is done with tangential direction feed rate specified by the F code.

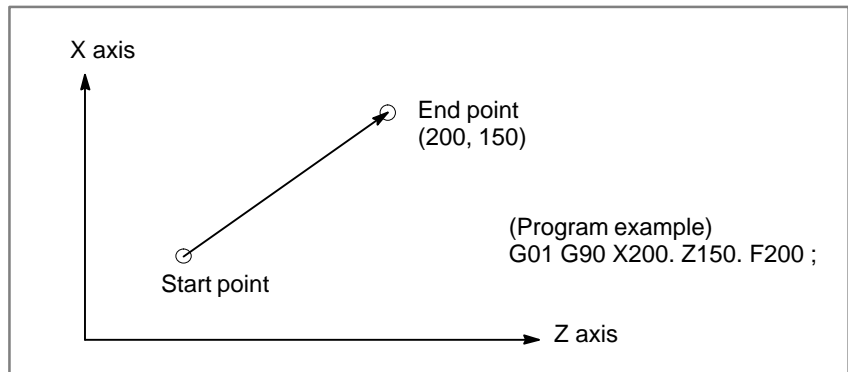

Format

G01 IP_ F_ ;

F : Feedrate

3.4 CIRCULAR INTERPOLATION (G02, G03)

Circular interpolation of optional angle from 0° to 360° can be specified.

G02: Clockwise (CW) circular interpolation

G03: Counterclockwise (CCW) circular interpolation

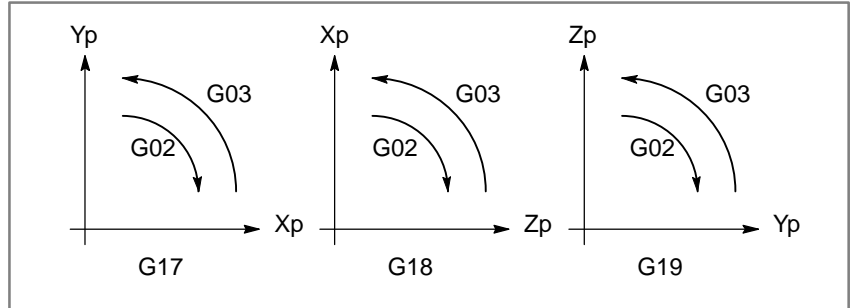

Feed rate of the tangential direction takes the speed specified by the F code. Planes to perform circular interpolation is specified by G17, G18, G19. Circular interpolation can be performed not only on the X, Y, and Z axis but also on the parallel axes of the X, Y, and Z axes.

G17: Xp-Yp plane

G18: Zp-Xp plane

G19: Yp-Zp plane

where

Xp: X axis or its parallel axis

Yp: Y axis or its parallel axis

Zp: Z axis or its parallel axis

Parameter is set to decide which parallel axis of the X, Y, Z axes to be the additional axis.

Format

Arc on the Xp-Yp plane

$$G17 \left\{ \begin{matrix} G02 \\ G03 \end{matrix} \right\} Xp_ Yp_ \left\{ \begin{matrix} R_ \\ I_ J_ \end{matrix} \right\} F_ ;$$

Arc on the Zp-Xp plane

$$G18 \left\{ \begin{matrix} G02 \\ G03 \end{matrix} \right\} Zp_ Xp_ \left\{ \begin{matrix} R_ \\ K_ I_ \end{matrix} \right\} F_ ;$$

Arc on the Yp-Zp plane

$$G19 \left\{ \begin{matrix} G02 \\ G03 \end{matrix} \right\} Yp_ Zp_ \left\{ \begin{matrix} R_ \\ J_ K_ \end{matrix} \right\} F_ ;$$

I_, J_, K_: Distance of the X, Y, Z axes from the start point to the center of the circle

R: Arc radius (For an arc having a central angle of 180° or greater, specify an R value with a minus sign. A complete circumference cannot be specified.)

When the option for specifying arc radius R with nine digits is selected for the T series, the valid radius range for circular interpolation is expanded as follows:

Without the option for specifying arc radius R with nine digits

		Input increments	
		Metric input	Inch input
Increment system	IS-B	0.001 to 99999.999mm	0.0001 to 9999.9999inch
	IS-C	0.0001 to 9999.9999mm	0.00001 to 999.99999inch

With the option for specifying arc radius R with nine digits

		Input increments	
		Metric input	Inch input
Increment system	IS-B	0.001 to 999999.999mm	0.0001 to 99999.9999inch
	IS-C	0.0001 to 99999.9999mm	0.00001 to 9999.99999inch

3.5 HELICAL INTERPOLATION (G02, G03)

Helical interpolation performs circular interpolation of a maximum of two axes, synchronizing with other optional two axes circular interpolation. Thread cutting of large radius threads or machining of solid cams are possible by moving a tool in a spiral.

The commanded speed is the speed of the tangential direction of the arc. Thus, the speed of a linear axis is expressed as follows:

$$F \times \frac{\text{Length of linear axis}}{\text{Arc length}}$$

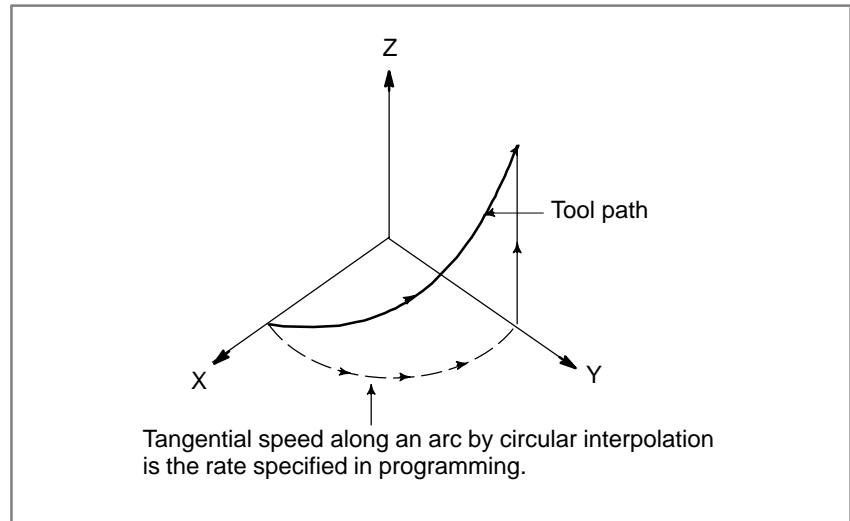

Format

Arc on the Xp-Yp plane

$$\mathbf{G17} \left\{ \begin{array}{l} \mathbf{G02} \\ \mathbf{G03} \end{array} \right\} \mathbf{Xp_ Yp_} \left\{ \begin{array}{l} \mathbf{R_} \\ \mathbf{I_ J_} \end{array} \right\} \alpha_ (\beta_) \mathbf{F_} ;$$

Arc on the Zp-Xp plane

$$\mathbf{G18} \left\{ \begin{array}{l} \mathbf{G02} \\ \mathbf{G03} \end{array} \right\} \mathbf{Zp_ Xp_} \left\{ \begin{array}{l} \mathbf{R_} \\ \mathbf{K_ I_} \end{array} \right\} \alpha_ (\beta_) \mathbf{F_} ;$$

Arc on the Yp-Zp plane

$$\mathbf{G19} \left\{ \begin{array}{l} \mathbf{G02} \\ \mathbf{G03} \end{array} \right\} \mathbf{Yp_ Zp_} \left\{ \begin{array}{l} \mathbf{R_} \\ \mathbf{J_ K_} \end{array} \right\} \alpha_ (\beta_) \mathbf{F_} ;$$

α, β : Optional axis other than the circular interpolation axes

3.6

HELICAL INTERPOLATION B (G02, G03)

M series

Helical interpolation B moves the tool in a helical manner. This interpolation can be executed by specifying the circular interpolation command together with up to four additional axes in simple high-precision contour control mode.

Basically, the command can be specified by adding two movement axes to a standard helical interpolation command (see Section 3.5). Address F should be followed by a tangential velocity, which has been determined by also taking movement along the linear axes into consideration.

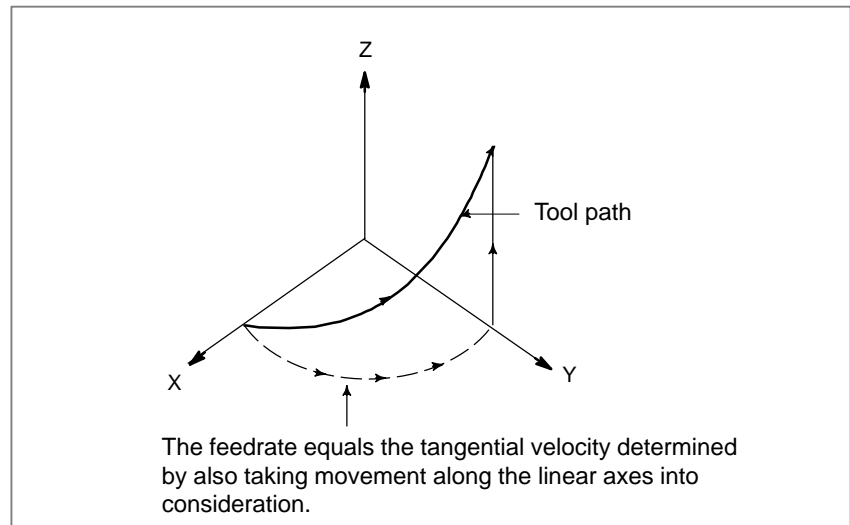

Format

With an arc in the Xp-Yp plane

$$\mathbf{G17} \left\{ \begin{array}{l} \mathbf{G02} \\ \mathbf{G03} \end{array} \right\} \mathbf{Xp_ Yp_} \left\{ \begin{array}{l} \mathbf{I_ J_} \\ \mathbf{R_} \end{array} \right\} \alpha_ \beta_ \gamma_ \delta_ \mathbf{F_};$$

With an arc in the Zp-Xp plane

$$\mathbf{G18} \left\{ \begin{array}{l} \mathbf{G02} \\ \mathbf{G03} \end{array} \right\} \mathbf{Zp_ Xp_} \left\{ \begin{array}{l} \mathbf{I_ K_} \\ \mathbf{R_} \end{array} \right\} \alpha_ \beta_ \gamma_ \delta_ \mathbf{F_};$$

With an arc in the Yp-Zp plane

$$\mathbf{G19} \left\{ \begin{array}{l} \mathbf{G02} \\ \mathbf{G03} \end{array} \right\} \mathbf{Yp_ Zp_} \left\{ \begin{array}{l} \mathbf{J_ K_} \\ \mathbf{R_} \end{array} \right\} \alpha_ \beta_ \gamma_ \delta_ \mathbf{F_};$$

$\alpha_ \beta_ \gamma_ \delta$: Any axis to which circular interpolation is not applied. Up to four axes can be specified.

3.7 POLAR COORDINATE INTERPOLATION (G12.1, G13.1)

The function in which contour control is done in converting the command programmed in a cartesian coordinate system to the movement of a linear axis (movement of a tool) and the movement of a rotary axis (rotation of a workpiece) is the polar coordinate interpolation. It is an effective function when a straight line groove is cut on the outer diameter of a workpiece or when a cam shaft is ground.

Whether the polar coordinate interpolation is done or not is commanded by a G code.

These G codes shall be commanded in a single block.

Format

G12.1; Polar coordinate interpolation mode
(Polar coordinate interpolation shall be done.)

G13.1; Polar coordinate interpolation cancel mode
(Polar coordinate interpolation is not done.)

Explanations

- **Polar coordinate interpolation mode (G12.1)**

The axes (linear axis and rotary axis) on which polar coordinate interpolation is done are set beforehand by parameters.

Change the mode to polar coordinate interpolation mode by commanding G12.1, and a plane (hereinafter referred to as polar coordinate interpolation plane) is selected in which linear axis is made to the first axis of the plane, and virtual axis being a right angle with the linear axis is made to the second axis of the plane. Polar coordinate interpolation is carried out on this plane.

In the polar coordinate interpolation made, the command of linear interpolation (G01) and circular interpolation (G02, G03) is possible. And both absolute command (G90) and incremental command (G91) are possible.

For the program command it is possible to apply cutter compensation. For the path after cutter compensation is done, polar coordinate interpolation can be made.

As for feedrate, specify the tangential speed (relative speed between the workpiece and the tool) on the polar coordinate interpolation plane (cartesian coordinate system) with F.

- **Polar coordinate interpolation cancel mode (G13.1)**

The polar coordinate interpolation cancel mode is obtained by G13.1 command.

Examples

- **Polar coordinate interpolation by X axis (Linear axis) and C axis (Rotary axis)**

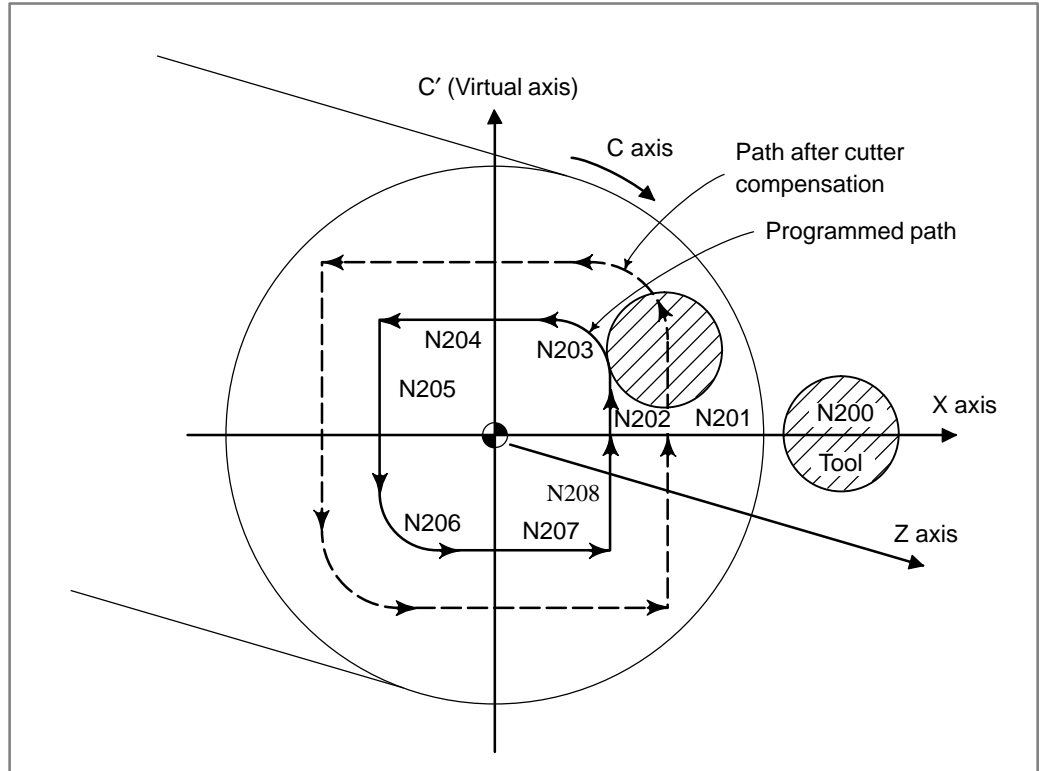

(X axis is diameter programming and C axis is radius programming)

00001;

:

N100 G90 G00 X120.0 C0 Z_ ;

Positioning to the starting position

N200 G12.1;

Starting polar coordinate interpolation

N201 G42 G01 X40.0 F D01;

N202 C10.0;

N203 G03 X20.0 C20.0 R10.0 ;

Contour program

N204 G01 X-40.0 ;

(Program in cartesian coordinate system of X-C' plane)

N205 G-10.0 ;

N206 G03 X-20.0 C-20.0 I10.0 K0 ;

N207 G01 X40.0 ;

N208 C0 ;

N209 G40 X120.0 ;

Canceling polar coordinate interpolation

N210 G13.1 ;

N300 Z_ ;

N400 X_ C_ ;

:

M30 ;

3.8 CYLINDRICAL INTERPOLATION (G07.1)

When the form on the expanded side view of a cylinder (from on the cylinder coordinate system) is commanded by a program command, the NC converts the form into a linear axis movement and a rotary axis movement then performs a contour control. This feature is called the cylindrical interpolation.

Cylindrical interpolation is commanded with G07.1.

Format

G07.1 (Name of rotary axis) Radius value of cylinder ;

Cylindrical interpolation mode

G07.1 (Name of rotary axis) 0 ;

Cancellation mode of cylindrical interpolation

Explanations

- **Cylindrical interpolation mode**

Cylindrical interpolation is made between the rotary axis specified in the block of G07.1 and the other optional linear axis.

Circle interpolation command is allowed as well as linear interpolation, during cylindrical interpolation mode. Also, absolute command and incremental command can be made. Cutter compensation can be added to the program command. Cylindrical interpolation is made for the path after cutter compensation.

Feed rate gives the tangential speed on the expanded plane of the cylinder with F.

- **Cancellation mode of cylindrical interpolation**

G07.1 (Name of rotary axis) 0; Cancellation mode of cylindrical interpolation is made when commanded as above.

Examples

An example of a program

O0001 (CYLINDRICAL INTERPOLATION);

N1 G00 G00 Z100.0 C0;

N2 G01 G18 Z0 C0;

N3 G7.1 C57299;

N4 G01 G42 Z120.0 D10 F250;

N5 G40.0;

N6 G02 Z90.0 C60.0 R30.0 ;

N7 G01 Z70.0;

N8 G03 Z60.0 C70.0 R10.0;

N9 G01 C150.0;

N10 G03 Z70.0 C190.0 R75.0;

N11 G01 Z110.0 C230.0;

N12 G02 Z120.0 C270.0 R75.0;

N13 G01 G360.0;

N14 G40 Z100.0;

N15 G07.1 C0;

N16

M30;

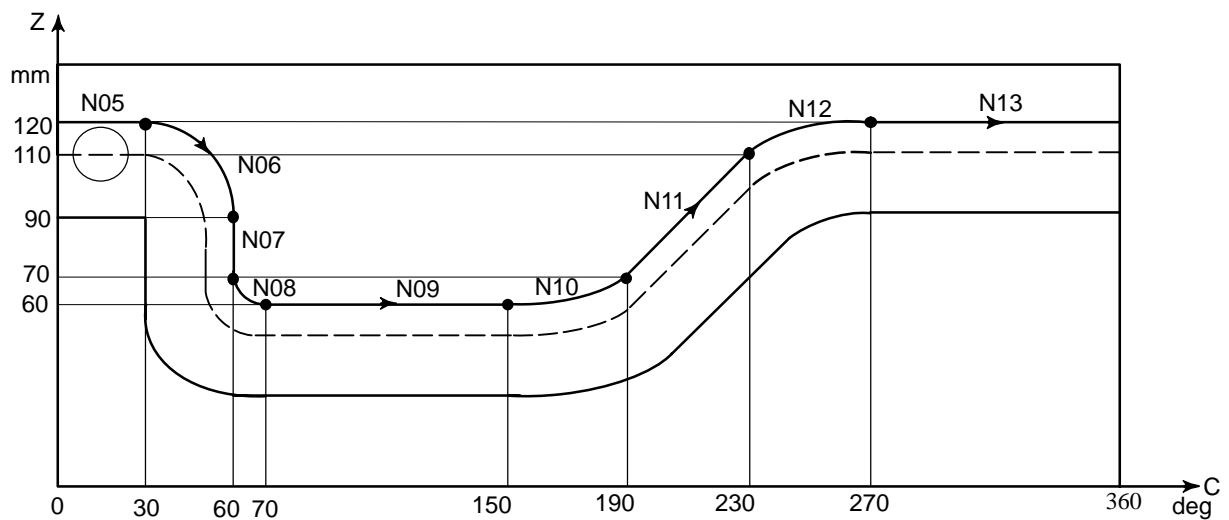
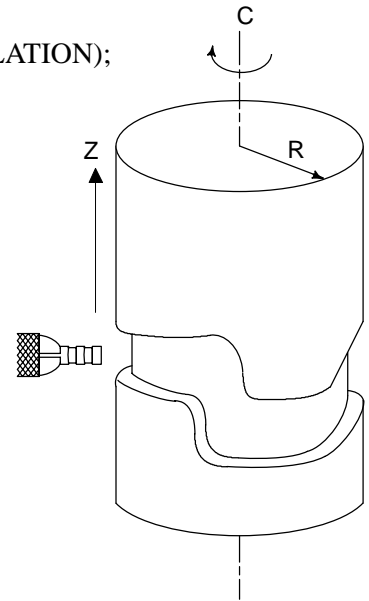

3.9 **M series** CYLINDRICAL INTERPOLATION CUTTING POINT COMPENSATION (G07.1)

The conventional cylindrical interpolation function controls the tool center so that the tool axis always moves along a specified path on the cylindrical surface, towards the rotation axis (cylindrical axis) of the workpiece. On the other hand, this function controls the tool so that the tangents to the tool and a contour figure cutting surface always pass through the rotation center of a workpiece.

This function is enabled in AI high-precision contour control mode or AI nano-precision contour control mode.

Format

```
G05 P10000 ; (AI high-precision contour control mode ON)
:
G07.1 IPr ; Sets cylindrical interpolation mode
:           (enables cylindrical interpolation).
:
G07.1 IP0 ; Clears cylindrical interpolation mode.
:
G05 P0 ;    (AI high-precision contour control mode OFF)
```

IP : One rotation axis address

r : Cylinder radius of rotation axis

Specify each of G07.1 IPr; and G07.1 IP0; singly in a block.

G107 can not be used.

Explanation

- Comparison with conventional cylindrical interpolation

As shown in Fig.3.9 (a), control is exercised along the offset axis (Y-axis) direction that is perpendicular to the tool, tool center axis, and workpiece rotation center axis.

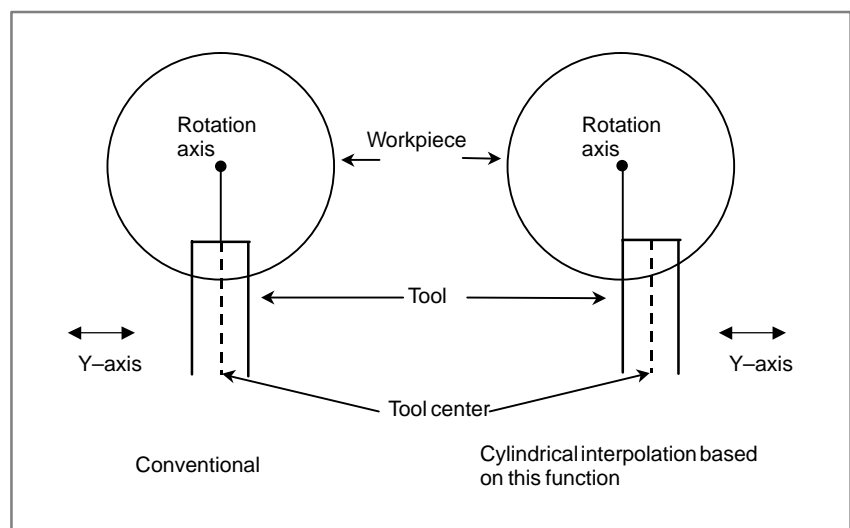

Fig.3.9 (a) Comparison with Conventional Interpolation

Example

- **Example of cylindrical interpolation cutting point compensation**

The sample program below indicates the positional relationships between a workpiece and tool.

```

O0001(CYLINDRICAL INTERPOLATION1) ;
N01 G00 G90 Z100.0 C0 ;
N02 G01 G91 G19 Z0 C0 ;
N03 G07.1 C57299 ;
N04 G01 G42 G90 Z120.0 D01 F250. ; ... (1)
N05 C20.0 ; ... (2)
N06 G02 Z110.0 C60.0 R10.0 ; ... (3)
N07 G01 Z100.0 ; ... (4)
N08 G03 Z60.0 C70.0 R40.0 ; ... (5)
:
M30 ;

```

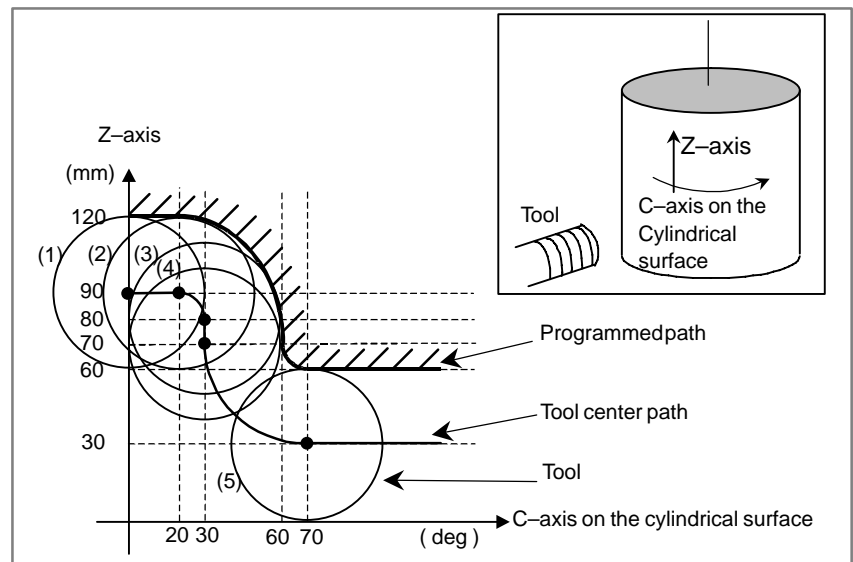

Fig.3.9 (b) Path of Sample Program for Cylindrical Interpolation Cutting Point Compensation

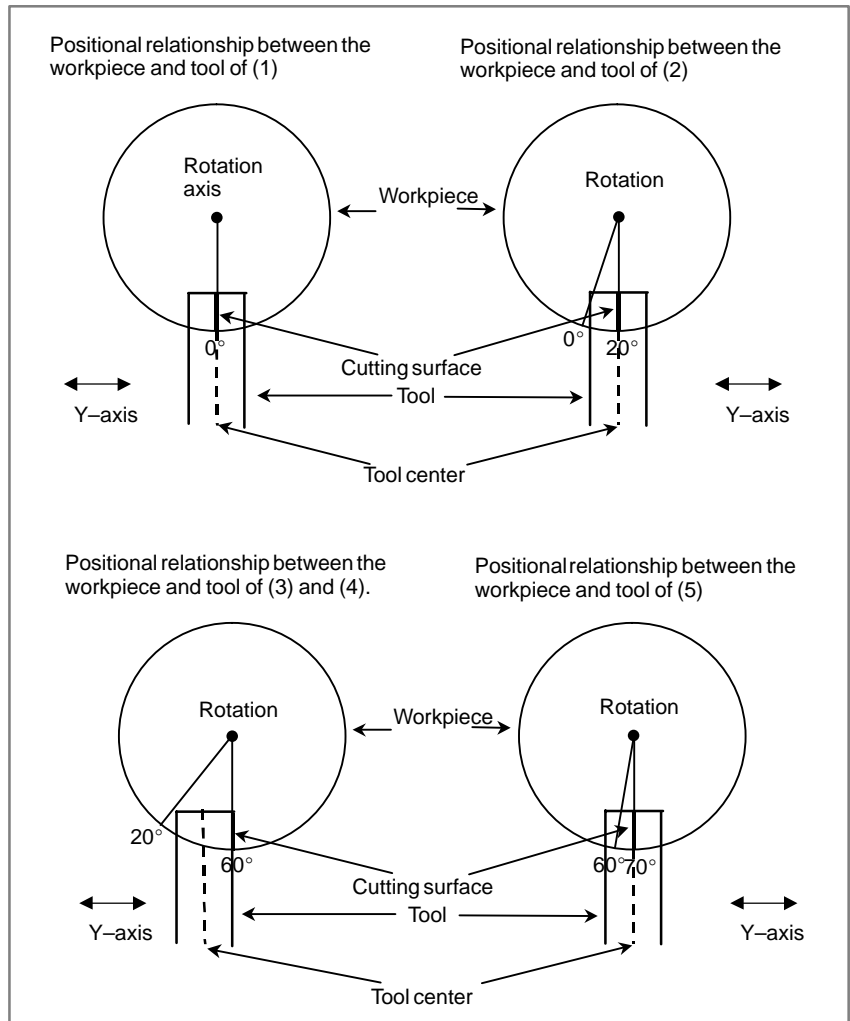
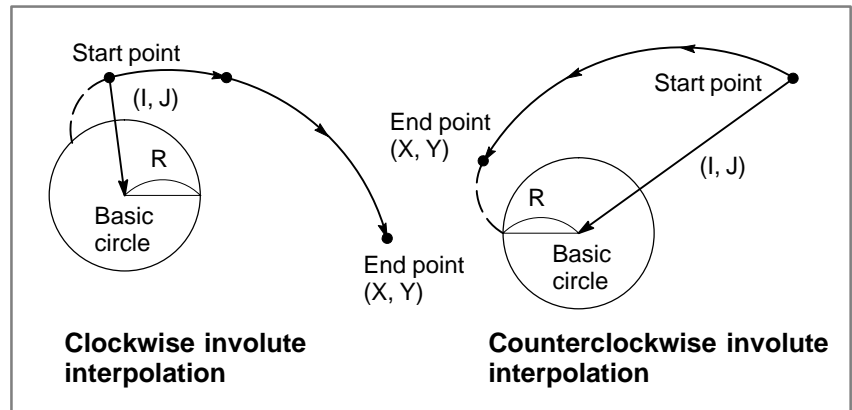

Fig.3.9 (c) Positional Relationships between Workpiece and Tool of Sample Program

3.10 INVOLUTE INTERPOLATION (G02.2, G03.2)

M series

With the following command, the involute curve machining can be performed. Approximate involute curve with a minute straight line or arc is not needed. Therefore, the programming becomes simple and reduces the tape length. The distribution of the pulse will not be interrupted during the continuous minute block high speed operation, so fast, smooth involute curve machining is possible.



Format

Xp-Yp plane

$$G17 \left\{ \begin{array}{l} G02.2 \\ G03.2 \end{array} \right\} Xp_ Yp_ I_ J_ R_ F_ ;$$

Zp-Xp plane

$$G18 \left\{ \begin{array}{l} G02.2 \\ G03.2 \end{array} \right\} Zp_ Xp_ K_ I_ R_ F_ ;$$

Yp-Zp plane

$$G19 \left\{ \begin{array}{l} G02.2 \\ G03.2 \end{array} \right\} Yp_ Zp_ J_ K_ R_ F_ ;$$

G02.2 : Clockwise involute interpolation

G03.2 : Counterclockwise involute interpolation

Xp, Yp, Zp : End point coordinate value

I, J, K : Distance to the center of the basic circle of the involute curve from start point

R : Radius of basic circle

F : Cutting feedrate

3.10.1 **M series** Involute Interpolation Automatic Feedrate Control Function

The involute interpolation automatic feedrate control function applies the following two types of override automatically to a specified feedrate during involute interpolation to cut more precise, better surfaces:

- Override when inner offsetting is performed in cutter compensation
- Override near the basic circle

(a) Override when inner offsetting is performed in cutter compensation

When cutter compensation is applied to involute interpolation, the feedrate is controlled so that the speed in the direction tangent to the path of the center of the tool (the tool center path) in normal involute interpolation becomes a specified feedrate.

Then, the speed of the tool periphery (the cutting point) along the programmed path that is the actual cutting speed changes as the curvature of the involute curve changes every moment.

In particular, when the tool is offset to the inner side of the involute curve, the actual cutting speed becomes higher than the specified feedrate as the tool gets closer to the basic circle.

For smooth machining, the actual cutting speed should be controlled so that it matches a specified feedrate. This function calculates an appropriate override value for the momentarily changing curvature of the involute curve during involute interpolation particularly when an inner offset is used, so that the actual cutting speed which is the tangential speed at the cutting point is always the specified feedrate.

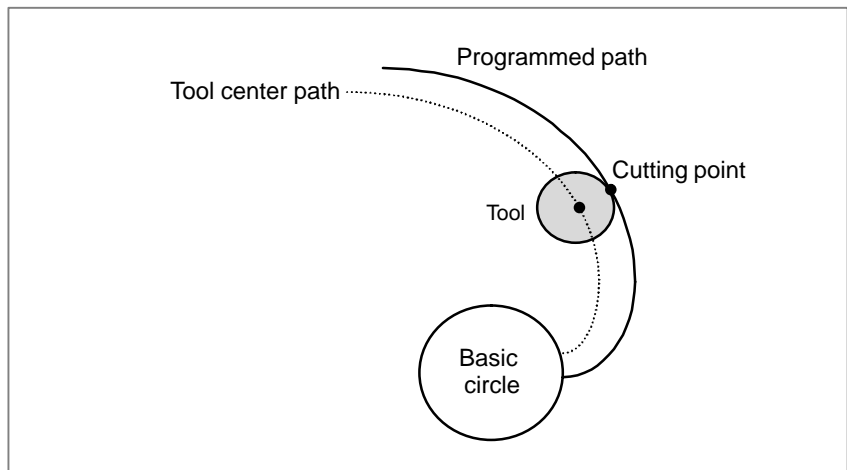

(b) Override near the basic circle

In an area near the basic circle, the change in curvature of the involute curve is relatively large. If such an area is cut at a programmed feedrate, a heavy load is applied to the cutter, which may prevent a good cut surface from being produced.

In an area near the basic circle where the change in curvature of the involute curve is relatively large, this function decelerates the tool movement automatically according to the parameter setting to reduce the cutter load, allowing a good cut surface to be obtained.

3.11 **M series**
EXPONENTIAL
FUNCTION
INTERPOLATION
(G02.3, G03.3)

In synchronization with the travel of the rotary axis, the linear axis (X axis) performs the exponential function interpolation. With the other axes, the linear interpolation the X axis is performed.

This function is effective for the tapered constant helix machining in the tool grinding machine.

This function is the best for the fluting with the end mill etc. and grinding.

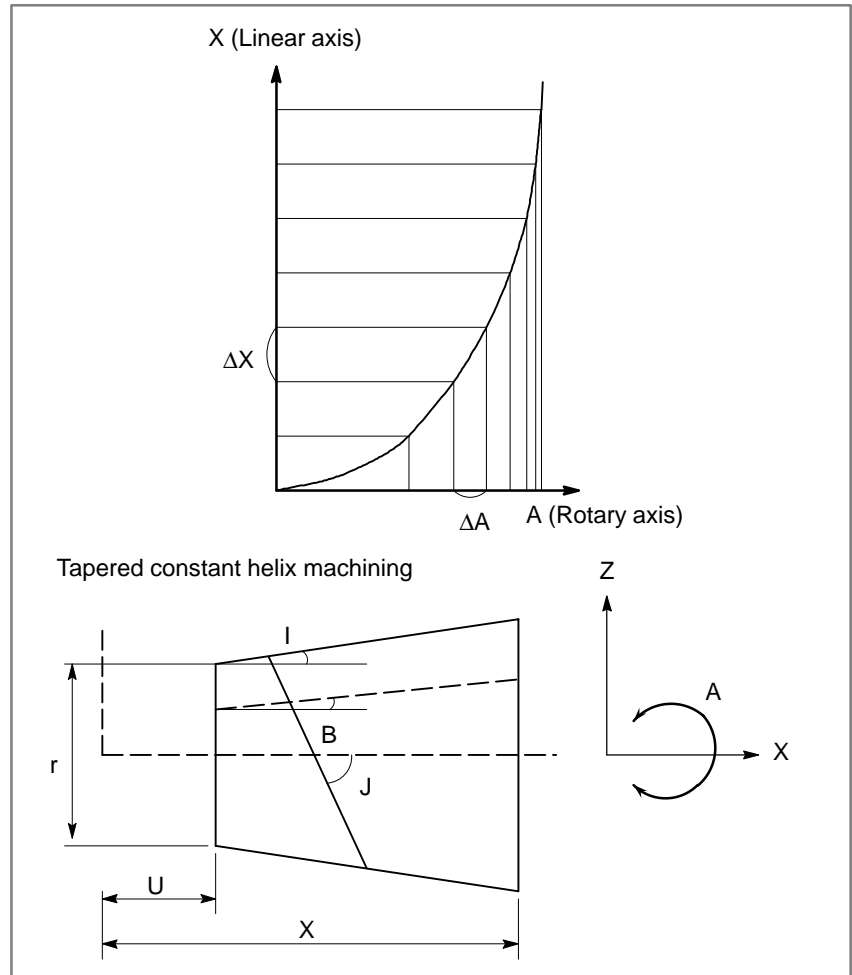

Format

Positive rotation ($\omega=0$)

G02.3 X_ Y_ Z_ I_ J_ K_ R_ F_ Q_ ;

Negative rotation ($\omega=1$)

G03.3 X_ Y_ Z_ I_ J_ K_ R_ F_ Q_ ;

X_ : Command terminal point by Absolute or incremental

Y_ : Command terminal point by Absolute or incremental

Z_ : Command terminal point by Absolute or incremental

I_ : Command of angle I (The command unit is 0.001 deg.
The range of command is 1 to ± 89 deg)

J_ : Command of angle J (The command unit is 0.001 deg.
The range of command is 1 to ± 89 deg)

K_ : Amount of division of the linear axis in the exponential function interpolation (amount of span). The command range is a positive value.)

R_ : Command of constant value R in the exponential function interpolation.

F_ : Command of initial feed rate.

The command is the same as the normal F code. The feed rate shall be given by the synthesized speed including the rotary axis.

Q_ : Command of feed rate at terminal point.

The command unit is based on the reference axis. Within the CNC, the tool is interpolated between the initial feed rate (F_) and final feed rate (Q_) depending on the amount of linear axis travel.

Explanations

The exponential function relation expression between the linear axis and the rotary axis is defined as in the following :

$$X(\theta) = R \times (e^{\frac{\theta}{K}} - 1) \times \frac{1}{\tan(I)} \quad \dots \dots \text{Travel of linear axis (1)}$$

$$A(\theta) = (-1)^\omega \times 360 \times \frac{\theta}{2\pi} \quad \dots \dots \text{Travel of rotation axis (2)}$$

$$K = \frac{\tan(J)}{\tan(I)}$$

$\omega=0$ or 1

R, I, J are constant and θ is the angle (radian) of rotation.
Also from the equation (1),

$$\theta(X) = K \times \ln \left\{ \frac{X \times \tan(I)}{R} + 1 \right\}$$

Thus, when the tool moves from X1 to X2 along the linear axis, the angle moved about the rotation axis is calculated as follows:

$$\Delta\theta = K \times \left\{ \ln \left(\frac{X_2 \times \tan(I)}{R} + 1 \right) - \ln \left(\frac{X_1 \times \tan(I)}{R} + 1 \right) \right\}$$

Specify formulas (1) and (2) in commands using the format described above.

3.12 **M series** SMOOTH INTERPOLATION (G05.1) (ONLY AT 1-PATH CONTROL)

Either of two types of machining can be selected, depending on the program command.

- For those portions where the accuracy of the figure is critical, such as at corners, machining is performed exactly as specified by the program command.
- For those portions having a large radius of curvature where a smooth figure must be created, points along the machining path are interpolated with a smooth curve, calculated from the polygonal lines specified with the program command (smooth interpolation).

In smooth interpolation mode, the CNC automatically determines, according to the program command, whether an accurate figure is required, such as at corners, or a smooth figure is required where the radius of curvature is large. If a block specifies a travel distance or direction which differs greatly from that in the preceding block, smooth interpolation is not performed for that block. Linear interpolation is performed exactly as specified by the program command. Programming is thus very simple.

Examples

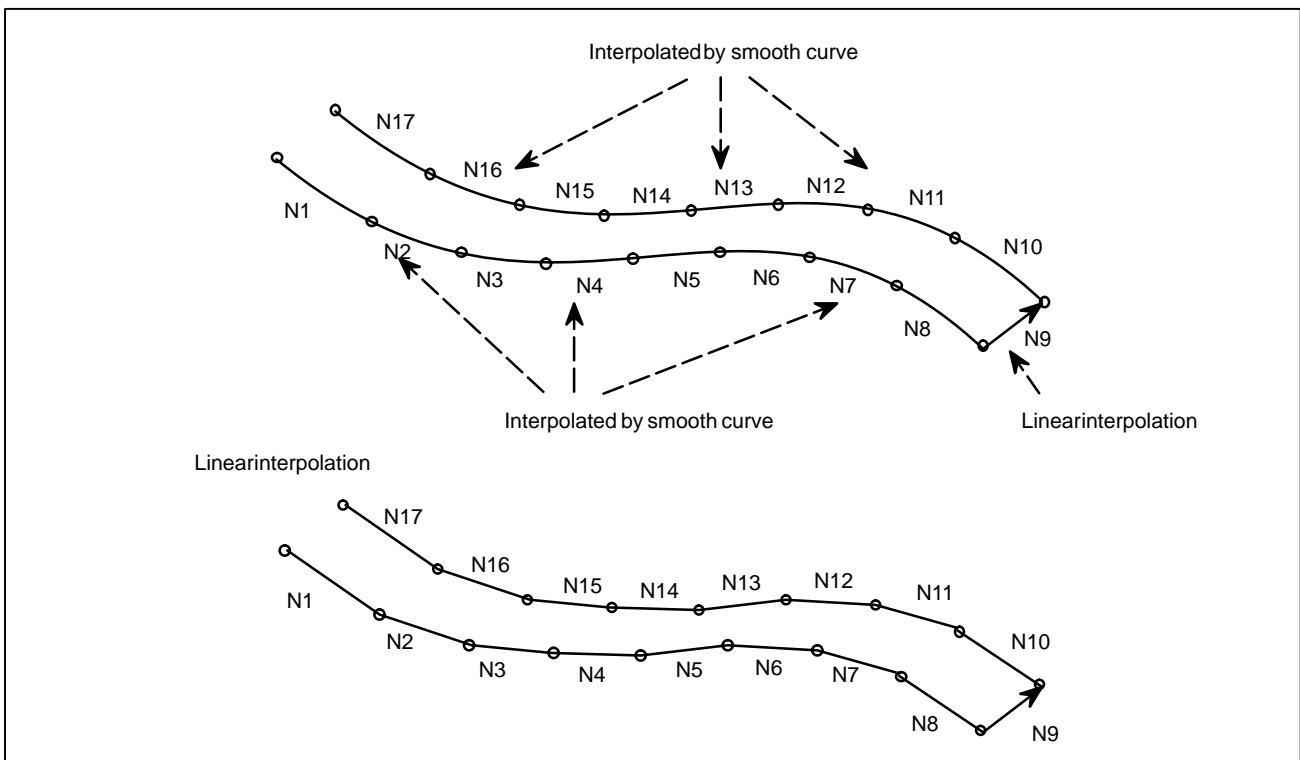

Smooth interpolation can be specified in high-speed contour control mode (between G05 P10000 and G05 P0). For details of high-speed contour control, see Section 20.6.

Format

Starting of smooth interpolation mode

```
G05.1 Q2X0Y0Z0;
```

Cancellation of smooth interpolation mode

```
G05.1 Q0;
```

3.13 HYPOTHETICAL AXIS INTERPOLATION (G07)

In helical interpolation, when pulses are distributed with one of the circular interpolation axes set to a hypothetical axis, sine interpolation is enable.

When one of the circular interpolation axes is set to a hypothetical axis, pulse distribution causes the speed of movement along the remaining axis to change sinusoidally. If the major axis for threading (the axis along which the machine travels the longest distance) is set to a hypothetical axis, threading with a fractional lead is enabled. The axis to be set as the hypothetical axis is specified with G07.

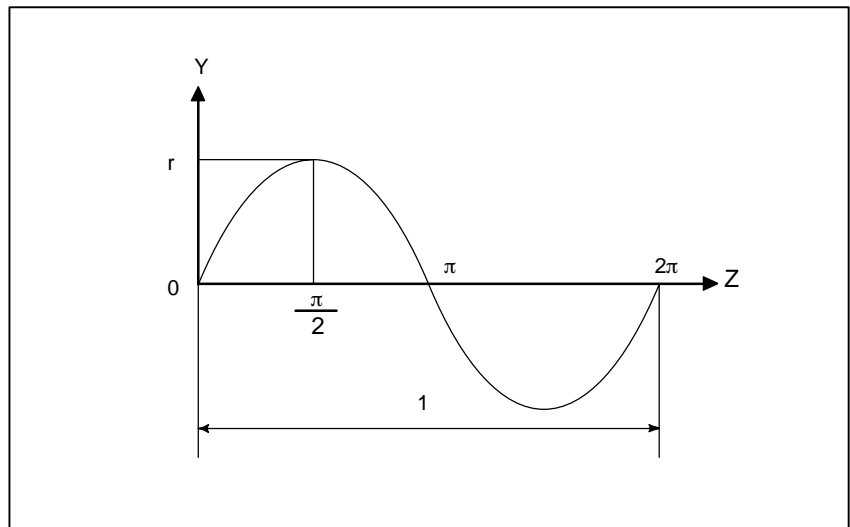

Format

G07 α **0**; Hypothetical axis setting

G07 α **1**; Hypothetical axis cancel

Where, α is any one of the addresses of the controlled axes.

3.14

SPIRAL INTERPOLATION, CONICAL INTERPOLATION

M series

Spiral interpolation is enabled by specifying the circular interpolation command together with a desired number of revolutions or a desired increment (decrement) for the radius per revolution.

Conical interpolation is enabled by specifying the spiral interpolation command together with one or two additional axes of movement, as well as a desired increment (decrement) for the position along the additional axes per spiral revolution.

Spiral interpolation and conical interpolation do not support bell-shaped acceleration/deceleration after interpolation for cutting feed.

- **Spiral interpolation**

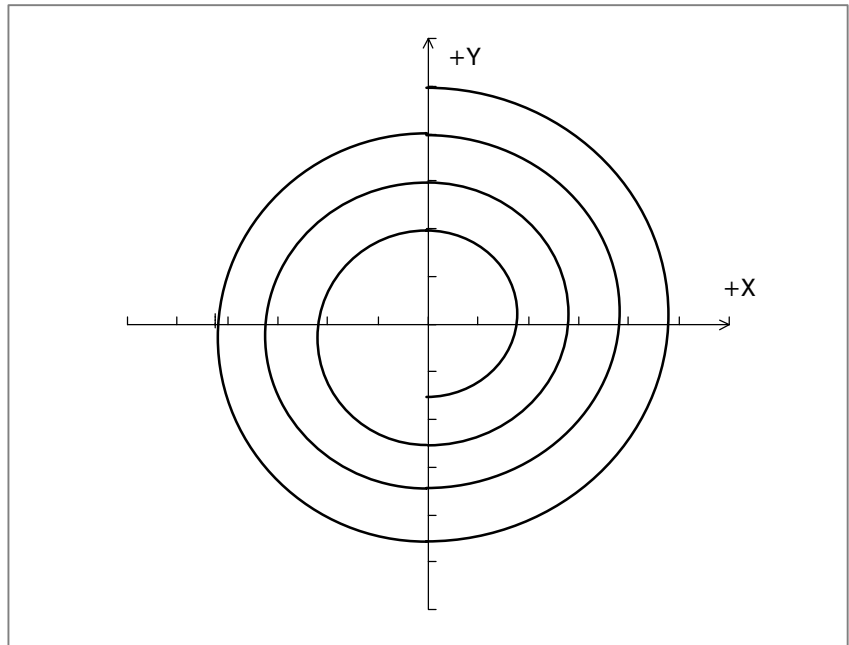

- **Conical interpolation**

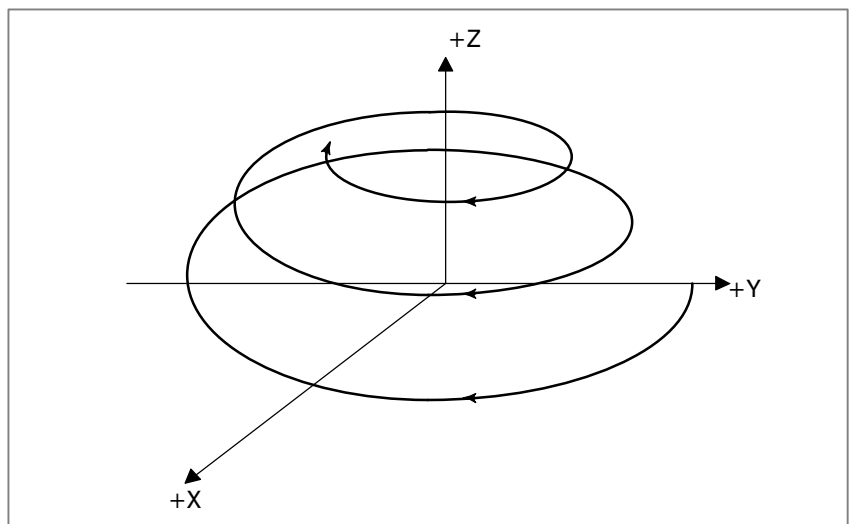

Format

• Spiral interpolation

Xp–Yp plane

$$\mathbf{G17} \left\{ \begin{array}{l} \mathbf{G02} \\ \mathbf{G03} \end{array} \right\} \mathbf{X_Y_I_J_Q_L_F_};$$

Zp–Xp plane

$$\mathbf{G18} \left\{ \begin{array}{l} \mathbf{G02} \\ \mathbf{G03} \end{array} \right\} \mathbf{Z_X_K_I_Q_L_F_};$$

Yp–Zp plane

$$\mathbf{G19} \left\{ \begin{array}{l} \mathbf{G02} \\ \mathbf{G03} \end{array} \right\} \mathbf{Y_Z_J_K_Q_L_F_};$$

X,Y,Z : Coordinates of the end point

L : Number of revolutions (positive value without a decimal point)

Q : Radius increment or decrement per spiral revolution

I, J, K : Signed distance from the start point to the center (same as the distance specified for circular interpolation)

F : Feedrate

• Conical interpolation

Xp–Yp plane

$$\mathbf{G17} \left\{ \begin{array}{l} \mathbf{G02} \\ \mathbf{G03} \end{array} \right\} \mathbf{X_Y_Z_I_J_K_Q_L_F_};$$

Zp–Xp plane

$$\mathbf{G18} \left\{ \begin{array}{l} \mathbf{G02} \\ \mathbf{G03} \end{array} \right\} \mathbf{Z_X_Y_K_I_J_Q_L_F_};$$

Yp–Zp plane

$$\mathbf{G19} \left\{ \begin{array}{l} \mathbf{G02} \\ \mathbf{G03} \end{array} \right\} \mathbf{Y_Z_X_J_K_I_Q_L_F_};$$

X,Y,Z : Coordinates of the end point

L : Number of revolutions (positive value without a decimal point)

Q : Radius increment or decrement per spiral revolution

I, J, K : Two of the three values represent a signed vector from the start point to the center. The remaining value is a height increment or decrement per spiral revolution in conical interpolation

When the Xp–Yp plane is selected:

The I and J values represent a signed vector from the start point to the center.

The K value represents a height increment or decrement per spiral revolution.

F : Feedrate (determined by taking movement along the linear axes into consideration)

3.15 NURBS INTERPOLATION (G06.2)

Many computer-aided design (CAD) systems used to design metal dies for automobiles and airplanes utilize non-uniform rational B-spline (NURBS) to express a sculptured surface or curve for the metal dies.

This function enables NURBS curve expression to be directly specified to the CNC. This eliminates the need for approximating the NURBS curve with minute line segments. This offers the following advantages:

1. No error due to approximation of a NURBS curve by small line segments
2. Short part program
3. No break between blocks when small blocks are executed at high speed
4. No need for high-speed transfer from the host computer to the CNC

When this function is used, a computer-aided machining (CAM) system creates a NURBS curve according to the NURBS expression output from the CAD system, after compensating for the length of the tool holder, tool diameter, and other tool elements. The NURBS curve is programmed in the NC format by using these three defining parameters: control point, weight, and knot.

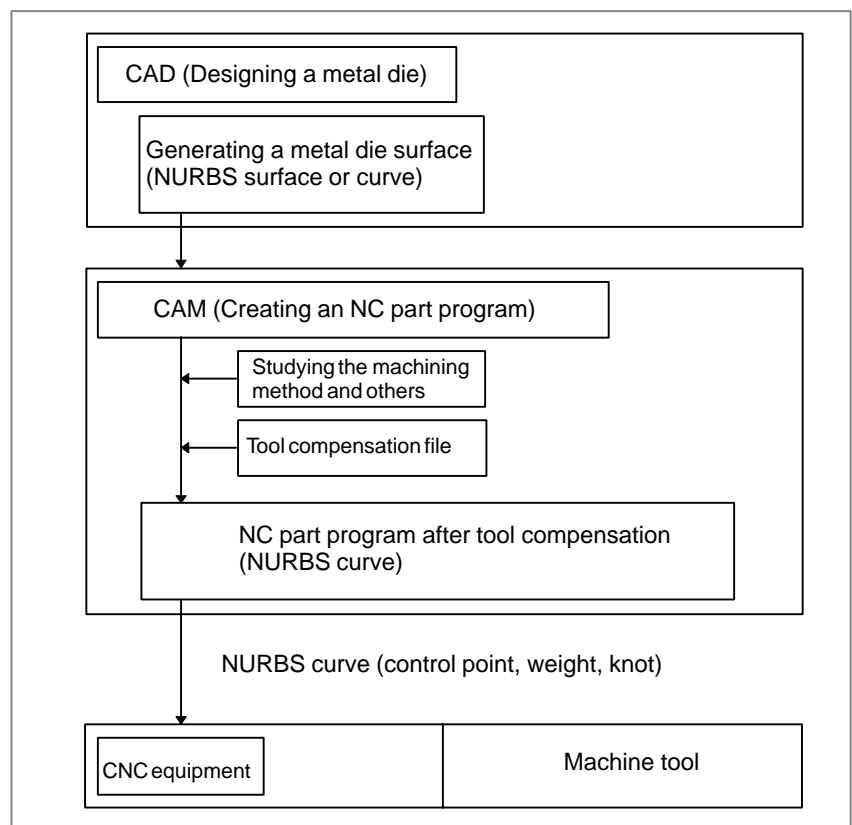

Fig. 3.15 NC part program for machining a metal die according to a NURBS curve

NURBS interpolation must be specified in high-precision contour control mode (between G05 P10000 and G05 P0). The CNC executes NURBS interpolation while smoothly accelerating or decelerating the movement so that the acceleration on each axis will not exceed the allowable maximum acceleration of the machine. In this way, the CNC automatically controls the speed in order to prevent excessive strain being imposed on the machine.

Format

G05 P10000 ;	(Start high-precision contour control mode)
...	
G06.2 [P_]	K_ X_ Y_ Z_ [R_] [F_];
	K_ X_ Y_ Z_ [R_];
	K_ X_ Y_ Z_ [R_];
	K_ X_ Y_ Z_ [R_];
	...
	K_ X_ Y_ Z_ [R_];
	K_;
	...
	K_;
G01 ...	
...G05 P0 ;	(End high-precision contour control mode)
G06.2	: Start NURBS interpolation mode
P_	: Rank of NURBS curve
X_ Y_ Z_	: Control point
R_	: Weight
K_	: Knot
F_	: Feedrate

3.16 3-DIMENSIONAL CIRCULAR INTERPOLATION (G02.4 AND G03.4)

Specifying an intermediate and end point on an arc enables circular interpolation in a 3-dimensional space.

Format

The command format is as follows:

G02.4 $X_{X1} Y_{Y1} Z_{Z1} \alpha_{\alpha1} \beta_{\beta1}$; **First block (mid-point of the arc)**
 $X_{X1} Y_{Y1} Z_{Z1} \alpha_{\alpha1} \beta_{\beta1}$; **Second block (end point of the arc)**
 α, β : Arbitrary axes other than the 3-dimensional circular interpolation axis (up to two axes)

Instead of G02.4, G03.4 can also be used. There is no difference in movement between these commands.

- **Start point, mid-point, and end point**

An arc in a 3-dimensional space is uniquely defined with its start point (current position) and a specified intermediate point and end point, as shown below. Two command blocks are used to define this arc. The first command block specifies the tool path between the start point and intermediate point. The second command block specifies the tool path between the intermediate point and end point.

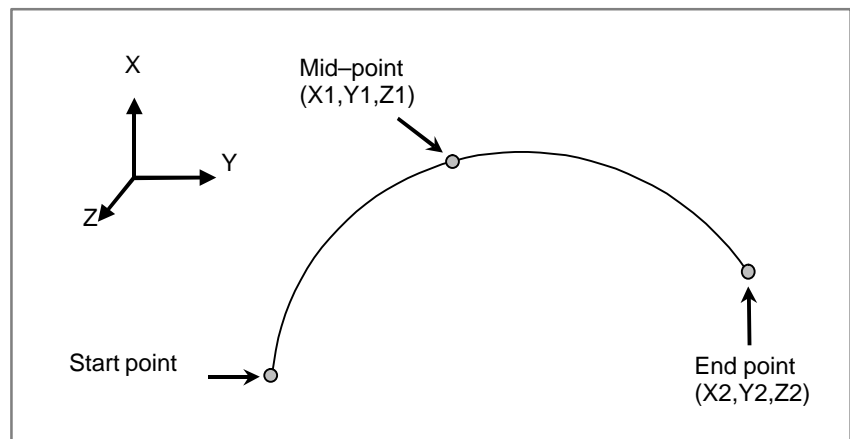

Fig. 3.16 Start, Mid, and End Points

4

THREAD CUTTING



4.1 EQUAL LEAD THREAD CUTTING (G33) (WITH G CODE SYSTEM A: G32)

By feeding the tool synchronizing with the spindle rotation, thread cutting of the specified lead is performed. In addition to straight threads, taper threads and scroll threads can be cut with equal leads.

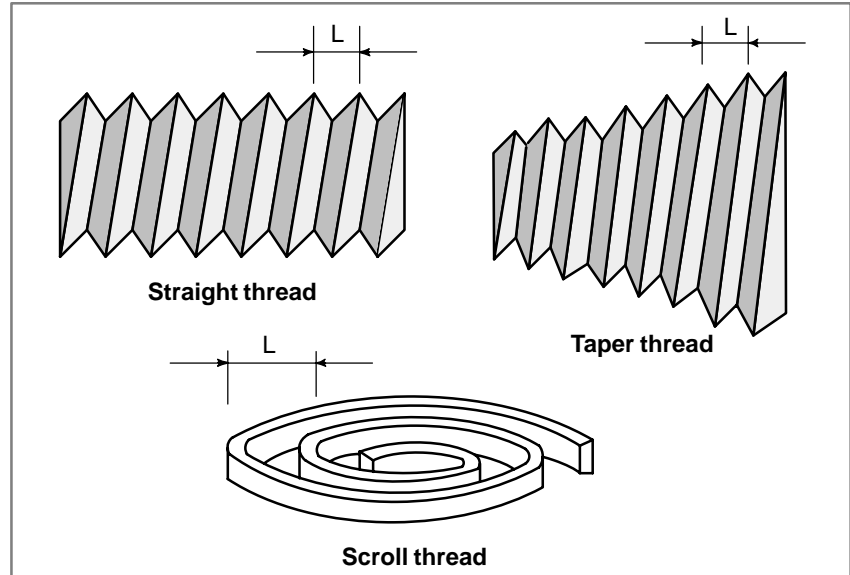

Format

G33 IP_ F_ :
 F_ : Lead along the long axis
 (axis having the largest amount of travel)

Explanations

To form a single thread, threading is generally performed several times from rough machining to finish machining along the same path. Threading starts when the one-revolution signal from the position coder attached to the spindle is detected. So threading always starts at the same point on the circumference of the workpiece, and threading is performed along the same path on the workpiece. In this case, however, the shaft must rotate at a constant speed during operations from rough machining to finish machining. If the spindle speed changes, an accurate thread may not be produced.

The following shows the specifiable lead range:

• **M series**

	Specifiable lead range
Metric input	F1 to F50000 (0.01 to 500.00mm)
Inch input	F1 to F99999 (0.0001 to 9.9999inch)

• **T series**

	Specifiable lead range
Metric input	0.0001 to 500.0000mm
Inch input	0.000001 to 9.99999inch

NOTE
 Leads exceeding the maximum cutting feed speed when converted to per minute feed speed cannot be specified.

4.2 T series MULTIPLE-THREAD CUTTING (G33)

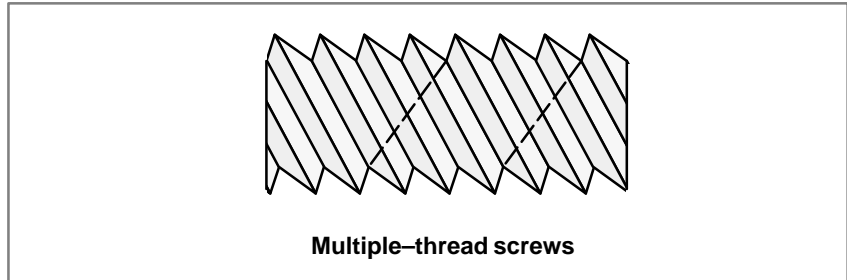

Format

Constant-lead threading

G33 IP_ F_ Q_ ;

G33 IP_ Q_ ;

IP_ : End point

F_ : Lead in longitudinal direction

Q_ : Threading start angle

4.3 T series VARIABLE LEAD THREAD CUTTING (G34)

Variable lead thread cutting can be done by commanding long axis direction lead and lead increase/decrease per spindle rotation.

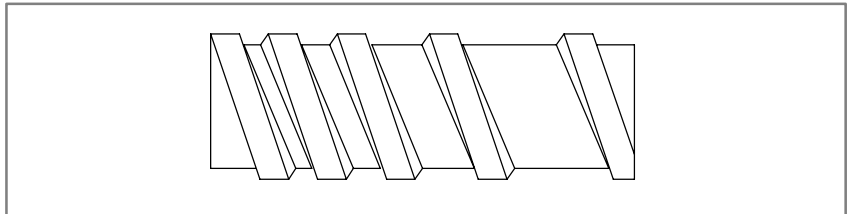

Format

G34 IP_ F_ K_ :

F_ : Long axis direction lead at start point

K_ : Lead increase/decrease per spindle rotation

**Command value range of
lead increase/decrease (K) per spindle rotation:**

Metric input	±0.0001 to ±500.0000 mm/rev
Inch input	±0.000001 to ±9.999999 inch/re

4.4 CONTINUOUS THREAD CUTTING

T series

Continuous thread cutting in which thread cutting command block is continuously commanded is available. As it is controlled so that the spindle synchronism shift (occurred when shifting from one block to another) is kept to a minimum, special threads like threads which leads or shape change during the cycle can also be cut.

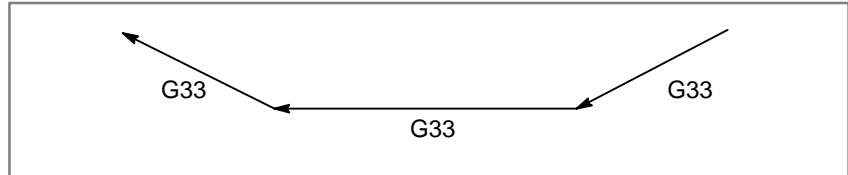

4.5 CIRCULAR THREADING (G35, G36)

T series

Using the G35 and G36 commands, a circular thread, having the specified lead in the direction of the major axis, can be machined.

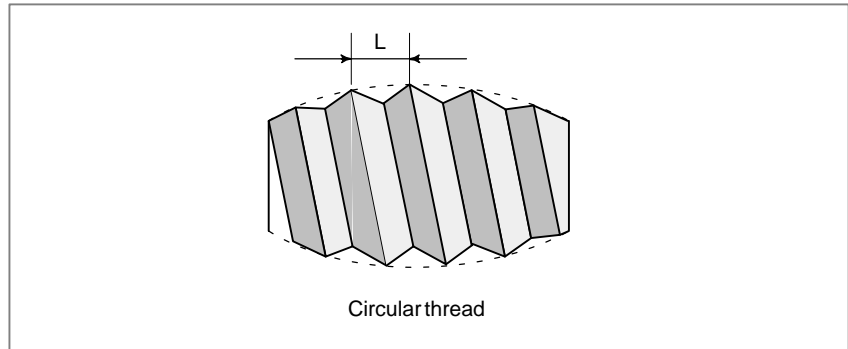

Format

$$\left\{ \begin{array}{l} \text{G35} \\ \text{G36} \end{array} \right\} X(U) _ Z(W) _ \left\{ \begin{array}{l} I _ K _ \\ R _ _ _ \end{array} \right\} F _ Q _$$

G35 : Clockwise circular threading command

G36 : Counterclockwise circular threading command

X (U) : Specify the arc end point (in the same way as for G02, G03).

Z (W)

I, K : Specify the arc center relative to the start point, using relative coordinates (in the same way as for G02, G03).

R : Specify the arc radius.

F : Specify the lead in the direction of the major axis.

Q : Specify the shift of the threading start angle (0 to 360° in units of 0.001°)

5

FEED FUNCTIONS



5.1 RAPID TRAVERSE

Positioning of each axis is done in rapid motion by the positioning command (G00).

There is no need to program rapid traverse rate, because the rates are set in the parameter (per axis).

Least command increment	Rapid traverse rate range
0.001mm, deg	30 to 240000mm/min, deg/min
0.0001mm, deg	30 to 100000mm/min, deg/min
0.0001inch	3.0 to 9600.0inch/min
0.00001inch	3.0 to 4000.0inch/min

NOTE

The above feed rates are limits according to the NC's interpolation capacity when the high-resolution detection interface is equipped. When the whole system is considered, there are also limits according to the servo system. For details, refer to Appendix A.

5.2 CUTTING FEED RATE

Feed rates of linear interpolation (G01), and circular interpolation (G02, G03) are commanded with numbers after the F code.

5.2.1 Tangential Speed Constant Control

In cutting feed, it is controlled so that speed of the tangential direction is always the same commanded speed.

5.2.2 Cutting Feed Rate Clamp

Cutting feed rate upper limit can be set as parameters. If the actual cutting feed rate (feed rate with override) is commanded exceeding the upper limit, it is clamped to a speed not exceeding the upper limit.

5.2.3 Per Minute Feed (G94) (G98 for G-code System A)

With the per minute feed mode G94, tool feed rate per minute is directly commanded by numerical value after F.

Least command increment	Cutting feed rate range
0.001mm, deg	1 to 240000mm/min, deg/min
0.0001mm, deg	1 to 100000mm/min, deg/min
0.0001inch	0.01 to 9600.0inch/min
0.00001inch	0.01 to 4000.0inch/min

NOTE

The above feed rates are limits according to the NC's interpolation capacity. When the whole system is considered, there are also limits according to the servo system. For details, see Appendix A.

5.2.4 Per Revolution Feed (G95) (G99 for G-code System A)

With the per revolution feed mode G95, tool feed rate per revolution of the spindle is directly commanded by numeral after F. A position coder must be mounted on the spindle.

For the T series, however, the feed-per-revolution command can be enabled by setting the corresponding parameter accordingly, even when the position coder is not installed (feed per revolution without position coder).

• M series

Least command increment	Cutting feed rate range
0.001mm, deg	0.01 to 500.00mm/rev, deg/rev
0.0001mm, deg	0.01 to 500.00mm/rev, deg/rev
0.0001inch	0.0001 to 9.9999inch/rev
0.00001inch	0.0001 to 9.9999inch/rev

• T series

Least command increment	Cutting feed rate range
0.001mm, deg	0.0001 to 500.0000mm/rev, deg/rev
0.0001mm, deg	0.0001 to 500.0000mm/rev, deg/rev
0.0001inch	0.000001 to 9.999999inch/rev
0.00001inch	0.000001 to 9.999999inch/rev

NOTE

The above feed rates are limits according to the CNC's interpolation capacity. When the whole system is considered there are also limits according to the servo system. For details, See Appendix A.

5.2.5 **M series** Inverse Time Feed (G93)

Inverse time feed mode is commanded by G93, and inverse time by F code. Inverse time is commanded with the following value in a 1/min unit.

In linear interpolation $F = \text{Speed}/\text{distance}$

In circular interpolation $F = \text{Speed}/\text{radius}$

When F0 is commanded, alarm occurs.

5.2.6 **M series** One-digit F Code Feed

When a 1-digit number from 1 to 9 is commanded after the F, the preset speed corresponding the 1-digit number commanded is set as feed rate. When F0 is commanded, rapid traverse is set.

Set the F1-digit feed rate change input signal on from the machine side, and rotate the manual pulse generator. Feed rate of the currently selected speed can be changed.

Feed rate set or changed will be memorized even after power is turned off.

5.3 OVERRIDE

5.3.1 Feed Rate Override

The per minute feed (G94) and per rotation feed (G95) can be overridden by:

0 to 254% (per every 1%).

In inverse time, feed rate converted to per minute feed is overridden. Feed rate override cannot be performed to F1-digit feed.

Feed rate also cannot be performed to functions as thread cutting and tapping in which override is inhibited.

5.3.2 Second Feed Rate Override

Cutting feed rate can be overridden by:

0 to 254% (per every 1%)

A second override can be performed on feed rates once overridden.

No override can be performed on functions as thread cutting and tapping in which override is inhibited.

This function is used for controlling feed rate in adaptive control, etc.

5.3.3 Rapid Traverse Override

Rapid traverse rate can be overridden by:

F0, 25%, 50%, 100%.

F0: A constant speed per axis is set by parameter

An override of 0% to 100% can be applied in 1% steps using a signal.

5.3.4 Override Cancel

Feed rate override and the second feed rate override can be clamped to 100% by a signal from the machine side.

5.3.5 Jog Override

The manual continuous feedrate and incremental feed rate can be overridden by:

0% to 655.34% (in steps of 0.01%)

5.4 AUTOMATIC ACCELERATION/ DECELERATION

Acceleration and deceleration is performed when starting and ending movement, resulting in smooth start and stop.

Automatic acceleration/deceleration is also performed when feed rate changes, so change in speed is also smoothly done.

- Rapid traverse : Linear acceleration/deceleration
(time constant is parameter set per axis)
- Cutting feed : Exponential acceleration/deceleration
(time constant is parameter set per axis)
- Jogging : Exponential acceleration/deceleration
(time constant is parameter set per axis)

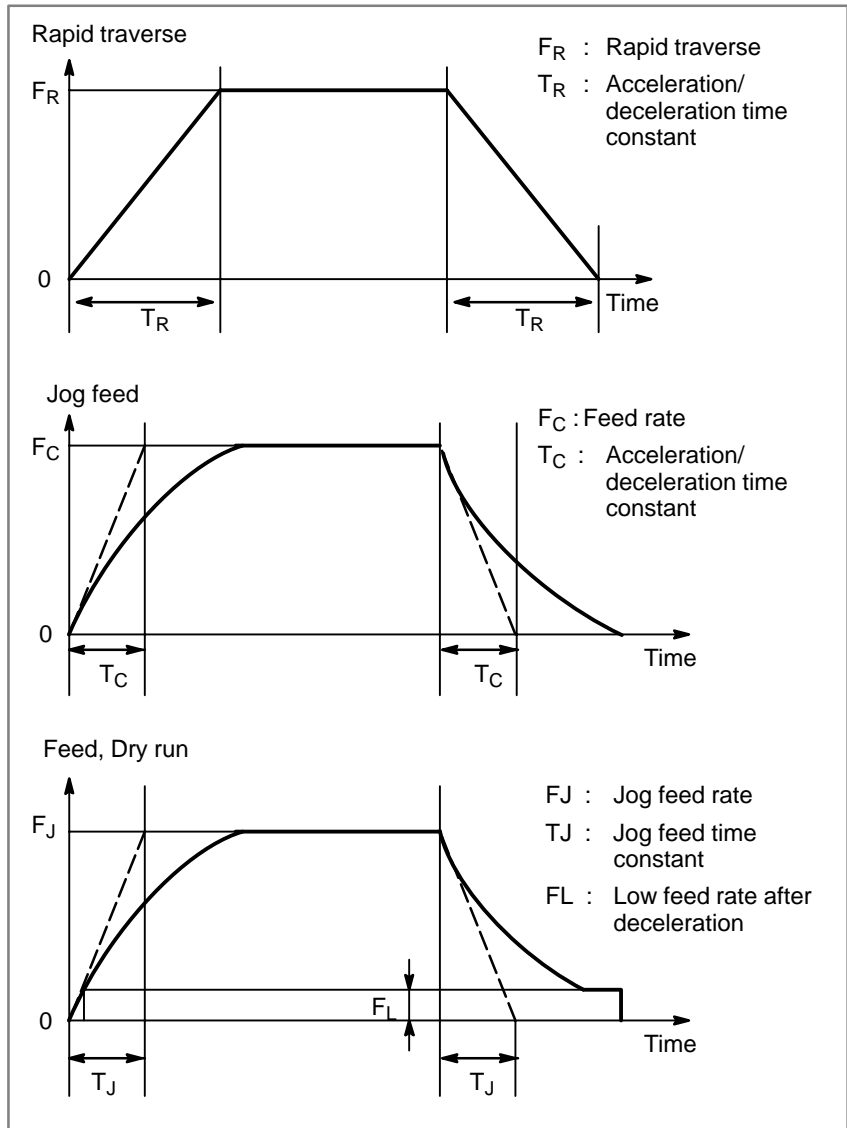

5.5 RAPID TRAVERSE BELL-SHAPED ACCELERATION/ DECCELERATION

The function for rapid traverse bell-shaped acceleration/deceleration increases or decreases the rapid traverse feedrate smoothly.

This reduces the shock to the machine system due to changing acceleration when the feedrate is changed.

As compared with linear acceleration/deceleration, bell-shaped acceleration/deceleration allows smaller time constants to be set, reducing the time required for acceleration/deceleration.

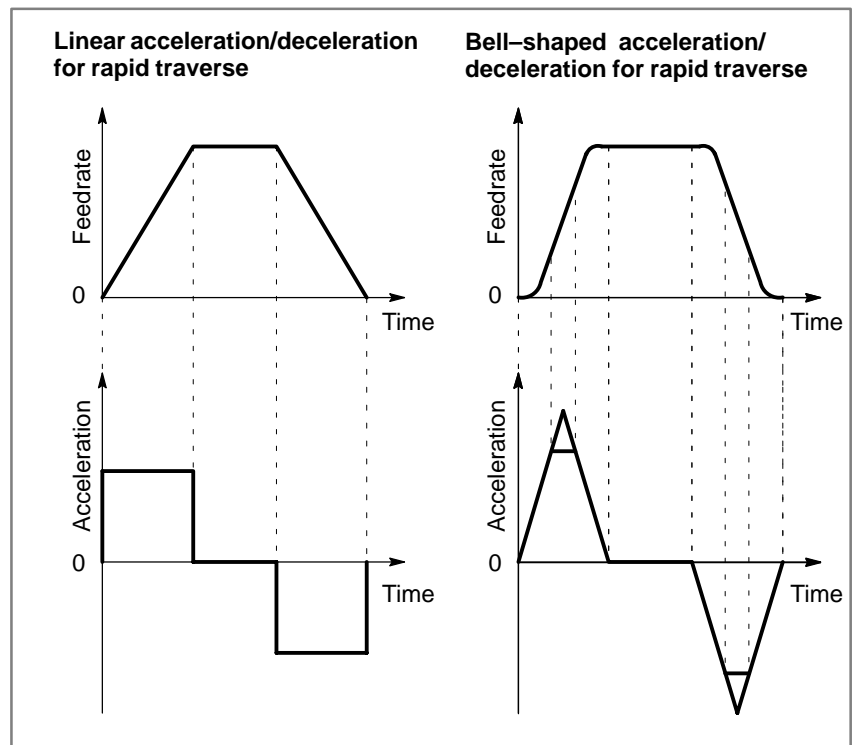

5.6 LINEAR ACCELERATION/ DECELERATION AFTER CUTTING FEED INTERPOLATION

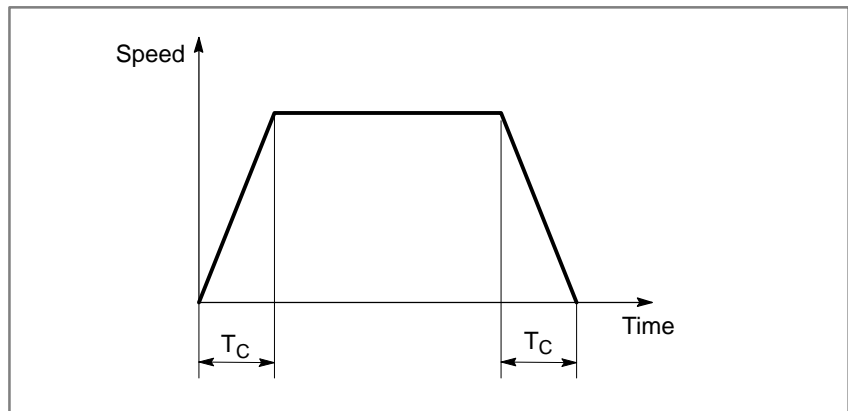

In the linear acceleration/deceleration, the delay for the command caused by the acceleration/ deceleration becomes 1/2 compared with that in exponential acceleration/deceleration, substantially reducing the time required for acceleration and deceleration.

Also, the radius direction error in the circular interpolation caused by the acceleration/deceleration is substantially reduced.

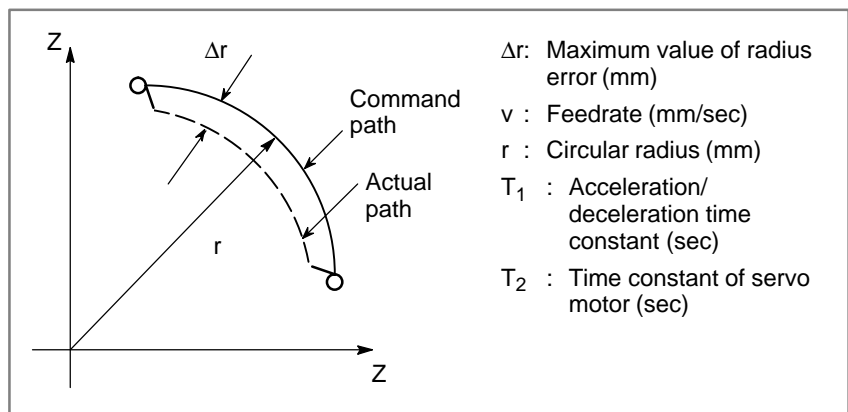

The maximum value of error in this radius direction is obtained approximately by the following equation.

$$\Delta r = \left(\frac{1}{2} T_1^2 + \frac{1}{2} T_2^2 \right) \frac{V^2}{r} \dots \dots \text{For exponential acceleration/deceleration}$$

$$\Delta r = \left(\frac{1}{24} T_1^2 + \frac{1}{2} T_2^2 \right) \frac{V^2}{r} \dots \dots \text{For linear acceleration/deceleration after cutting feed interpolation}$$

Consequently, in case of the linear acceleration/deceleration after interpolation, if an error caused by the servo loop time constant is excluded, the radius directional error will be reduced to 1/12, compared with the exponential acceleration/deceleration.

5.7 BELL-SHAPED ACCELERATION/ DECELERATION AFTER CUTTING FEED INTERPOLATION

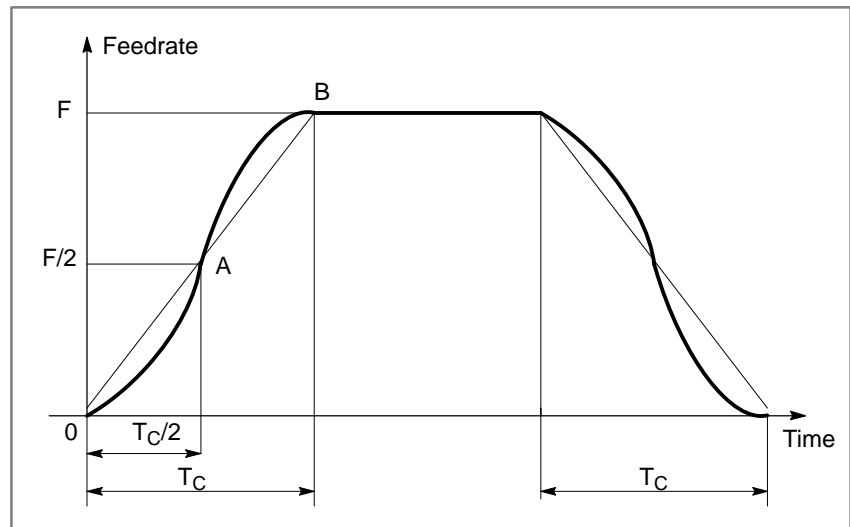

As shown above in the quadratic curve, it is possible to accelerate and decelerate the cutting feedrate.

When the acceleration and deceleration section are connected, the composed curve shapes just like a hanging bell. That is why this kind of acceleration/deceleration is called bell-shaped acceleration/deceleration. Considering a time constant as T_c (time spent to accelerate from feedrate 0 up to commanded feedrate F or time spent to decelerate from commanded feedrate F down to feedrate 0), feedrate accelerates up to $1/2$ of the commanded feedrate ($F/2$) for $1/2$ of the time constant ($T_c/2$). The acceleration/deceleration curve OA shown in the figure above can be expressed by the following equation :

$$f(t) = \frac{2F}{T_c^2} t^2$$

The curve AB and OA are symmetric with respect to point A .

The feature of this acceleration/deceleration is that the feedrate change is small near feedrate 0 and the commanded feedrate.

5.8 LINEAR ACCELERATION/ DECELERATION BEFORE CUTTING FEED INTERPOLATION

In response to the cutting feed command , the feedrate before interpolation, the command feedrate can be directly accelerated/ decelerated. This enables a machined shape error caused by the delay of acceleration/deceleration to be eliminated.

- Exponential acceleration/deceleration after cutting feed interpolation

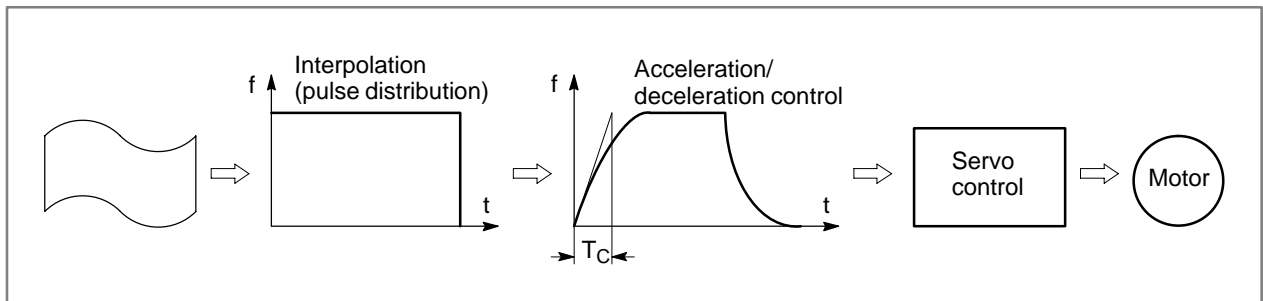

- Linear acceleration/ deceleration after cutting feed interpolation

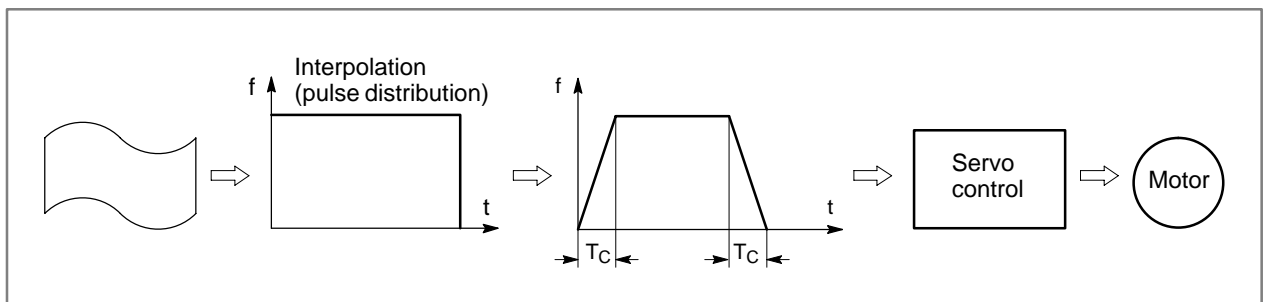

- Linear acceleration/ deceleration before cutting feed interpolation

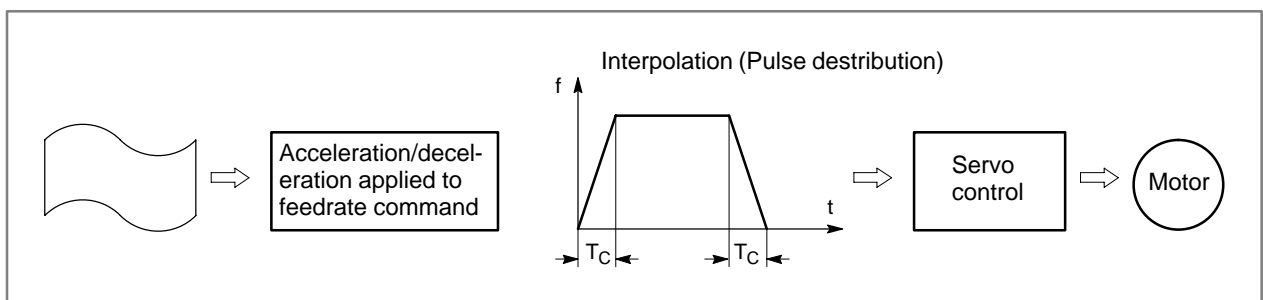

5.9 **T series**
ERROR DETECTION

Generally, the CNC does not zero the feedrate at the interface of two blocks during cutting feed. Because of this, a corner of a tool path may be rounded.

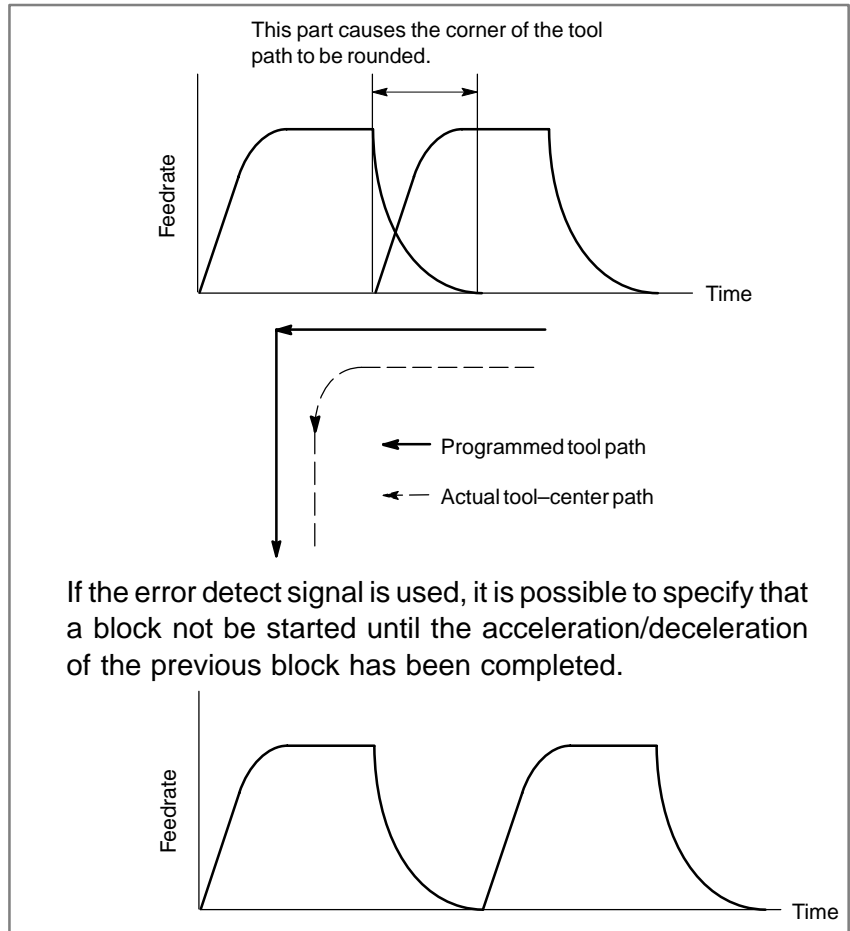

NOTE

If the error detect signal is on, a cutting block is not executed until the acceleration/deceleration of the previous cutting block has been completed. This function alone cannot prevent corner rounding due to delay caused by the servo motor, however. To prevent corner rounding due to delay caused by the servo motor, use the in-position check function together with this function.

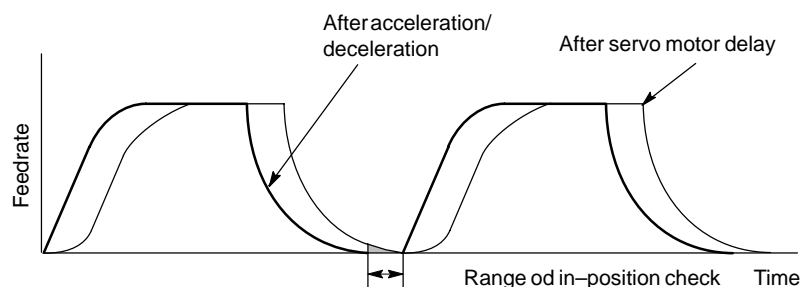

5.10 **M series** EXACT STOP (G09)

Move command in blocks commanded with G09 decelerates at the end point, and in-position check is performed. G09 command is not necessary for deceleration at the end point for positioning (G00) and in-position check is also done automatically. This function is used when sharp edges are required for workpiece corners in cutting feed.

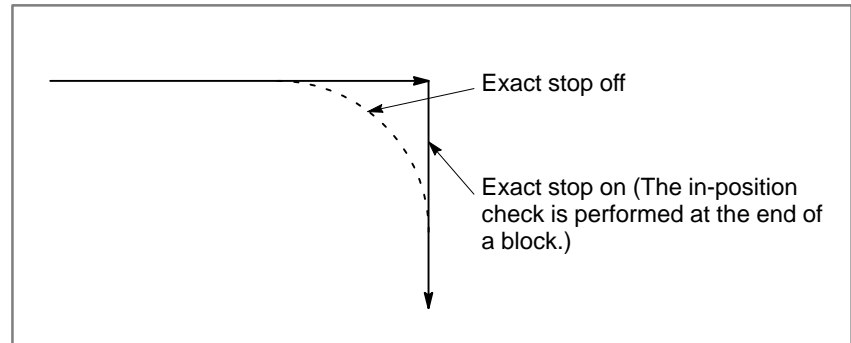

5.11 **M series** EXACT STOP MODE (G61)

When G61 is commanded, deceleration of cutting feed command at the end point and in-position check is performed per block thereafter. This G61 is valid till G64 (cutting mode), G62 (automatic corner override), or G63 (tapping mode) is commanded.

5.12 **M series** CUTTING MODE (G64)

When G64 is commanded, deceleration at the end point of each block thereafter is not performed and cutting goes on to the next block. This command is valid till G61 (exact stop mode), G62 (automatic corner override), or G63 (tapping mode) is commanded.

5.13 **M series** TAPPING MODE (G63)

When G63 is commanded, feed rate override is ignored (always regarded as 100%), and feed hold also becomes invalid. Cutting feed does not decelerate at the end of block to transfer to the next block. And in-tapping signal is issued during tapping operation. This G63 is valid till G61 (exact stop mode), G62 (automatic corner override), or G64 (cutting mode) is commanded.

5.14 **M series** AUTOMATIC CORNER OVERRIDE (G62)

When G62 is commanded during cutter compensation, cutting feed rate is automatically overridden at corner. The cutting quantity per unit time of the corner is thus controlled not to increase. This G62 is valid till G61 (exact stop mode), G64 (cutting mode), or G63 (tapping mode) is commanded.

5.15 DWELL (G04)

With the G04 command, shifting to the next block can be delayed.

When commanded with a per minute feed mode (G94), shifting to the next block can be delayed for the commanded minutes.

When commanded with a per rotation feed mode (G95), shifting to the next block can be delayed till the spindle rotates for the commanded times.

Dwell may always be performed by time irrespective of G94 and G95 by parameter selection.

Format

Per second dwell

G94 G04 { **P_**
X_ } ;

P_ or X_ : Dwell time commanded in seconds (0.001-99999.999 sec)

Per revolution dwell

G95 G04 { **P_**
X_ } ;

P_ or X_ : Spindle rotation angle commanded in rev.
(0.001-99999.999 rev)

5.16 POSITIONING BY OPTIMUM ACCELERATION

When a rapid traverse command is specified during automatic operation, the function for positioning by optimum acceleration can be used to adjust the rapid traverse rate, time constant, and loop gain, according to the amount of travel for the block. This reduces the time required for positioning and position check, therefore reducing the cycle time.

When rapid traverse is specified in automatic operation, the function adjusts the rapid traverse rate, time constant, and loop gain to one of seven levels, according to the amount of travel for the block. The relationship between the amount of travel and the corresponding rapid traverse rate, time constant, and loop gain is specified in parameters. This function is not effective for cutting feed.

5.17 RAPID TRAVERSE BLOCK OVERLAP

If rapid traverse blocks are specified successively, or if the block next to a rapid traverse block does not include any tool movements, the execution of the next block can be started when the feedrate of each axis in the rapid traverse block has decreased to the parameter-set deceleration ratio.

Examples

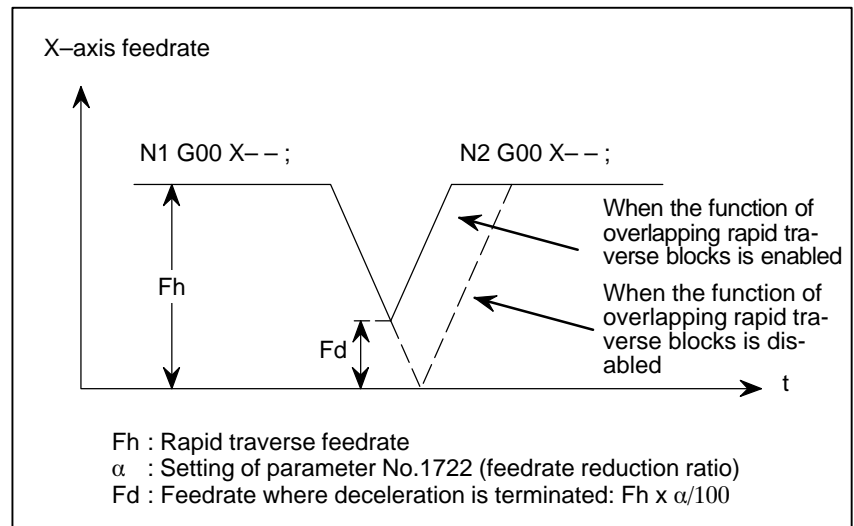

NOTE

The parameter No.1722 is effective when parameter No.1601 #4 (RT0) is set to 1.

6

REFERENCE POSITION



6.1 MANUAL REFERENCE POSITION RETURN

Positioning to the reference position can be done by manual operation. With jogging mode (JOG), manual reference position return (ZRN) signals, and signal for selecting manual reference position return axis ($\pm J1$ to $\pm J8$) on, the tool the machine is turned on, it decelerates, and when it is turned off again, it stops at the first grid point, and reference position return end signal is output. This point is the reference position.

By performing manual reference position return, the machine coordinate system and the work coordinate system is established.

There is only one method available to perform manual reference point return:

In the grid method, a certain grid of the position detection is appointed as the reference position. The reference position position can be shifted by the grid shift function.

6.2 SETTING THE REFERENCE POSITION WITHOUT DOGS

This function moves the machine to around the reference position set for each axis in the manual continuous feed mode. Then it sets the reference position for the machine in the manual reference position return mode without the deceleration signal for reference position return. With this function, the machine reference position can be set at a given position without the deceleration signal for reference position return.

Explanations

- **Setting the reference position**

1 Place the machine in the manual continuous feed mode, and perform positioning to a position near but not exceeding the reference position from reference position return direction (setting by parameter).

2 Enter the manual reference position return mode, then input the feed axis direction select signal (+) or (-) for the axis.

3 Positioning is made at the grid point located nearest from the current point to reference position return direction. This point is recorded as the reference position. If the absolute-position detector is provided, the set reference position is retained after the power is turned off. In this case, when the power is turned on again, there is no need for setting the reference position again.

- **Reference position return**

1 After the reference position is set, when the feed axis select signal (+) or (-) is input for the axis in the reference position return mode, reference position return operation is performed in rapid traverse regardless of which signal (+) or (-) is input.

6.3

M series

AUTOMATIC REFERENCE POSITION RETURN (G28, G29)

- Return to reference position (G28)

With the G28 command, the commanded axis is positioned to the reference position via the commanded point. After positioning, the reference position return end lamp lights. If G28 was commanded when reference position return is not performed after power on, reference position return is done in the same sequence as the manual reference position return.

G28IP_ ;

IP : Command intermediate point

- Return from reference position (G29) (M series)

With the G29 command, the commanded axis is positioned to the point commanded by G29, via the intermediate point commanded by G28.

G29IP_ ;

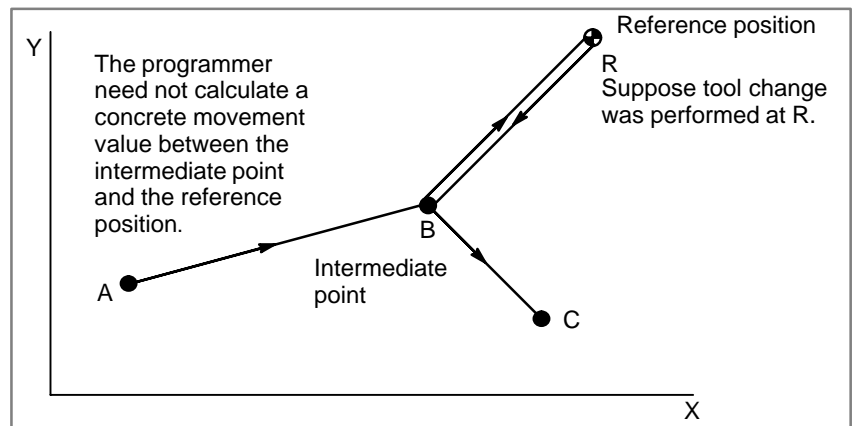

Example of use of G28 and G29

6.4 REFERENCE POSITION RETURN CHECK (G27)

This function is used to check whether the reference position return command was performed correctly.

When G27 is commanded, the commanded axis is positioned to the specified position, reference position return end signal is output if reference position return is performed to the correct position, and alarm arises if it is not positioned correctly to the reference point.

This function is available after power is turned on and reference position return is performed.

Format

G27 IP _ ;

6.5 2ND, 3RD AND 4TH REFERENCE POSITION RETURN (G30)

With the G30 command, the commanded axis is positioned to the 2nd, 3rd, or the 4th reference position, via the commanded point. 2nd, 3rd, or 4th reference position return end signal is output when positioning ends. Set the 2nd, 3rd, and 4th reference position position as parameters.

This function is available after power is turned on and reference position return is performed.

G29 can be used to return from the 2nd, 3rd, and 4th reference point (same as reference position return, G28) (M series only).

This function can be used once reference position return has been performed after power-on.

Format

G30 $\left\{ \begin{array}{l} \mathbf{P2} \\ \mathbf{P3} \\ \mathbf{P4} \end{array} \right\}$ **IP _ ;**

P2, P3, P4: Select from 2nd, 3rd, or 4th reference positions.
If not selected, 2nd reference position return is automatically selected.

6.6 FLOATING REFERENCE POSITION RETURN (G30.1)

It is possible to return the tool to the floating reference position by commanding the G30.1.

The floating reference position is located on the machine and can be a reference position of some sort of machine operation. It is not always a fixed position but may vary in some cases. The floating reference position can be set using the soft keys of MDI and can be memorized even if the power is turned off.

Generally, the position where the tools can be replaced on machining center, milling machine is a set position on top of the machinery. The tools cannot be replaced at any machine angle. Normally the tool replacement position is at any of the No. 1 to No. 4 reference position. The tool can be restored to these positions easily by G30 command. However, depending on the machine, the tools can be replaced at any position as long as it does not contact the workpiece.

In lathes, the tool can generally be changed at any position unless it touches the workpiece or tailstock.

For machinery such as these, in order to reduce the cycle time, it is advantageous to replace tools at a position as close as possible to the work. For this purpose, tool replacement position must be changed for each work shape and this feature can be easily realized by this function. Namely, the tool replacement position which is suitable for works can be memorized as the floating reference position and it is possible to return the tool to the tool replacement position easily by commanding the G30.1.

Format

G30.1 IP_ ;

IP : It is the intermediate point to the floating reference position and is commanded by an absolute value or an incremental value.

Explanations

When the G30.1 is commanded, the axis commanded is set to the intermediate point with rapid traverse at first and then is set to the floating reference position from the intermediate point with rapid traverse. The positioning to the intermediate point or to the floating point is performed at rapid traverse for each axis (non-linear positioning). The floating reference position return completion signal is output after completing the floating reference position return.

Examples

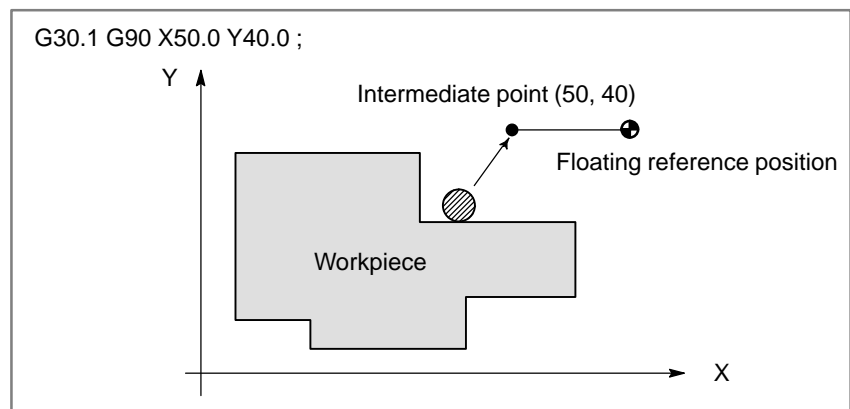

6.7 REFERENCE POSITION SHIFT

For reference position return using the grid method, you can shift the reference position without having to move the deceleration dog, simply by setting the amount of shift in a parameter.

The time required to adjust the reference position is thus greatly reduced because the deceleration dog need not be adjusted.

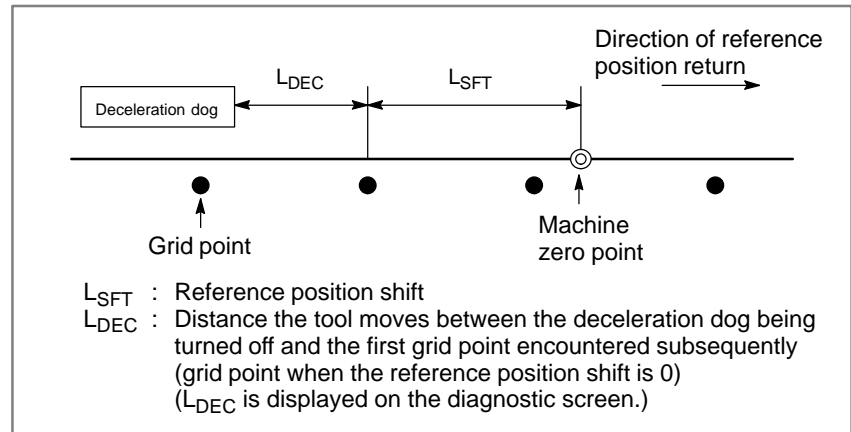

6.8 BUTT-TYPE REFERENCE POSITION SETTING

The butt-type reference position setting function automates the setting of a reference position by butting the tool against a mechanical stopper on an axis. This function is provided to eliminate the variations in reference position setting that arise when the procedure is performed by different operators, and to minimize the amount of workpiece involved in making fine adjustments after reference position setting.

Select the axis for which the reference position is to be set, then perform cycle start. The following operations are performed automatically:

1. The torque (force) of the selected axis is reduced so that the butting feedrate is constant. The tool is butted against the mechanical stopper. Then, the tool is drawn back a parameter-set amount from the mechanical stopper.
2. Again, the torque (force) of the selected axis is reduced, then the tool is butted against the mechanical stopper. Then, the tool is drawn back a parameter-set amount from the mechanical stopper.
3. The point on the axis to which the tool is drawn back is set as the reference position.

6.9 LINEAR SCALE WITH ABSOLUTE ADDRESSING REFERENCE MARKS

The linear scale with absolute addressing reference marks has reference marks (one-rotation signals) at intervals that change at a constant rate. By determining the reference mark interval, the corresponding absolute position can be deduced. The CNC makes a small movement along an axis to measure the one-rotation signal interval, then calculates the absolute position. The reference position can be established without performing positioning to the reference position.

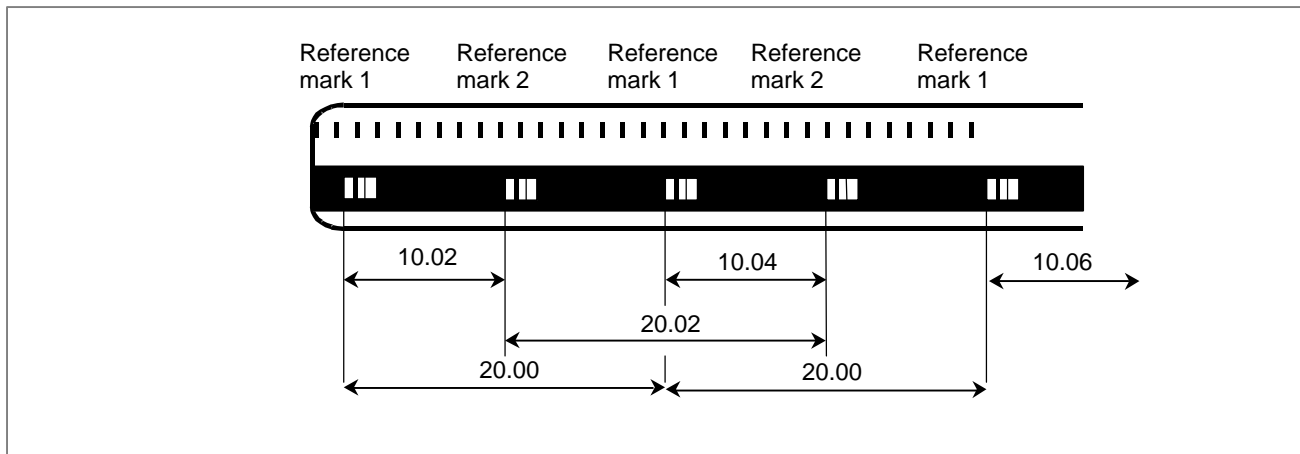

Fig. 6.9 Sample linear scale with absolute addressing reference marks

6.10 LINEAR SCALE EXPANSION FUNCTION WITH ABSOLUTE ADDRESSING REFERENCE MARKS

The linear scale expansion function with absolute addressing reference marks which is an optional function measures the reference mark interval automatically to establish a reference position when a G00 command or a jog-feed movement is specified.

6.11 LINEAR INTERPOLATION G28, G30, AND G53

When the linear interpolation type is set for positioning operation (bit 1 (LRP) of parameter No. 1401 is set to 1), linear interpolation can also be applied to the following operations by setting bit 4 (ZLN) of parameter No. 1015 to 1:

- Movement from an intermediate point to reference position during automatic reference point return (G28)
- Movement from an intermediate point to reference position during return to the second, third, or fourth reference position (G30)
- Positioning in machine coordinate system selection (G53)

When linear interpolation is applied to the above operations, acceleration/deceleration is controlled according to the setting of bit 4 (RCT) of parameter No. 1603.

7

COORDINATE SYSTEMS



By teaching the CNC the position the tool is to arrive, the CNC moves the tool to that position. The position is specified using coordinates on a certain coordinate system.

There are three types of coordinate systems.

- **Machine coordinate system**
- **Workpiece coordinate system**
- **Local coordinate system**

As necessary, one of the above coordinate systems is used for specifying coordinates for the target position of the tool.

7.1 MACHINE COORDINATE SYSTEM (G53)

Machine coordinate system is a coordinate system set with a zero point proper to the machine system.

A coordinate system in which the reference point becomes the parameter-preset coordinate value when manual reference point return is performed, is set. With G53 command, the machine coordinate system is selected and the axis is able to be moved in rapid traverse to the position expressed by the machine coordinates.

Format

```
G53 IP_ ;
```

NOTE

For use of machine coordinate system selection (G53), the workpiece coordinate system option is required.

• High-speed G53 function

When the function for overlap between rapid traverse blocks is enabled between a block containing a machine coordinate system selection command (G53) and a block containing a positioning (rapid traverse) command (G00), the rapid traverse command (G00) can be executed before the tool stops through deceleration at the end of the machine coordinate system selection command (G53). This can speed up positioning even when the machine coordinate system selection command (G53) is used.

Specifying P1 in the G53 block enables the high-speed G53 function.

Format

```
G53 IP_ P1 ;
```

G53 : G code for selecting the machine coordinate system (00 group)

IP_ : End point dimension word

P1 : Enables the high-speed G53 function.

7.2 WORKPIECE COORDINATE SYSTEM

A coordinate system in which the zero point is set to a fixed point on the workpiece, to make programming simple.

A workpiece coordinate system may be set by using the following methods:

- (1) Using G92 (G50 for T series with G code system A)
- (2) Automatic setting
- (3) Using G54 to G59

When (1) is used, a workpiece coordinate system is established using the numeric value programmed after G92.

When (2) is used, a workpiece coordinate system is automatically established upon a manual reference position return, as specified in a parameter.

When (3) is used, six workpiece coordinate systems must be set from the MDI panel in advance. The workpiece coordinate system to be used is selected by specifying a code selected from G54 to G59.

7.2.1 Setting a Workpiece Coordinate System (Using G92) (with G Code System A: G50)

Format

```
(G90) G92IP _ ;
```

Examples

- Example 1

By using the above command, a workpiece coordinate system can be set so that the current tool position is at a specified position.

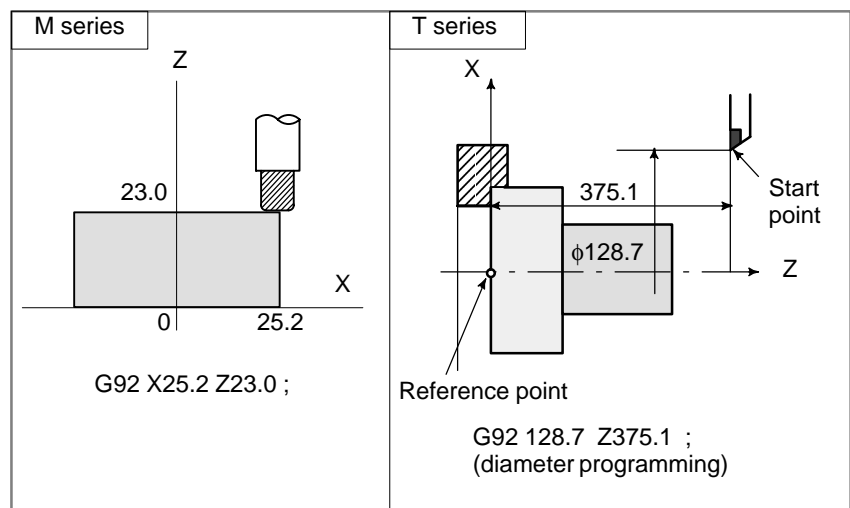

- **Example 2**

Set the reference point on the tool holder or turret as shown in the figure below, then specify G92 at the beginning of the program. By specifying an absolute command in this condition, the reference point is moved to a specified position. To move the tool tip to a specified position, compensate the distance between the reference point and the tool tip by using tool length compensation (for the M series) or tool offset (for the T series).

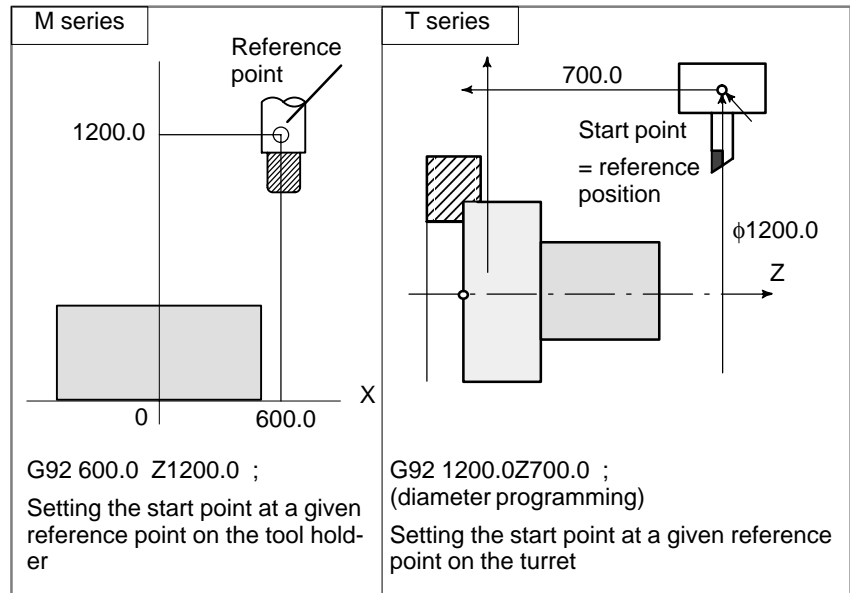

When a new workpiece coordinate system is created by specifying G92, it is determined so that a given point on the tool has a given coordinate value. So, there is no need to be concerned with old workpiece coordinate systems. Particularly when the start point for machining is determined based on the workpiece, the G92 command is useful. In this case, a desired coordinate system can newly be created even if an old workpiece coordinate system is invalid.

- **Example 3**

**(Shift of a workpiece coordinate system)
(T series)**

A workpiece coordinate system can be shifted by using the following command:

When this command is specified, a new coordinate system is created so that the current coordinate value (x, z) at a given point on the tool (for example, the tool tip) becomes (x+u, z+w).

For the x and u values, diameters must be set if diameter programming is specified, or radii must be set if radius programming is specified.

Format

(G91) G92 X(u) Z(w) ;

With G code system A: G50U(u)W(w);

Examples

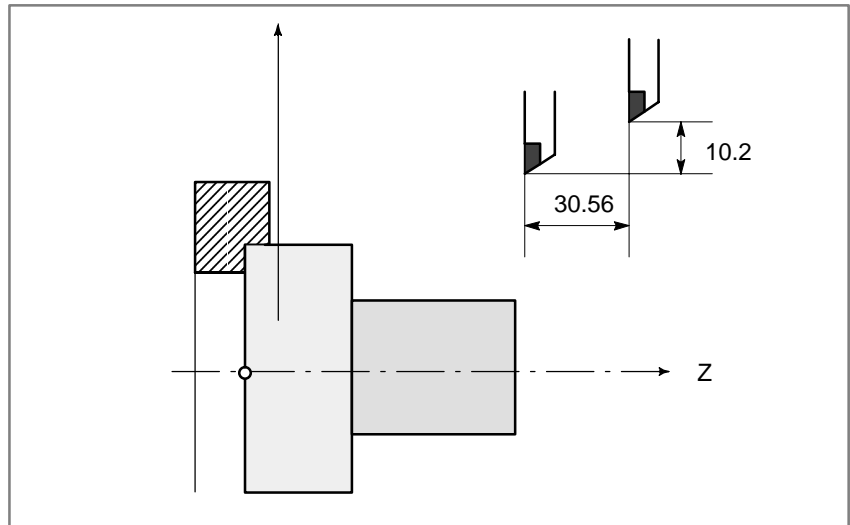

When tool A is switched to tool B, G91 G92 X20.4 Z30.56 (diameter programming) is specified.

7.2.2 Automatic Coordinate System Setting

When manual reference position return is performed, a workpiece coordinate system can be set automatically so that the current tool position at the reference position becomes a desired position which is set using a parameter in advance. This functions as if G92IP__ were specified at the reference position.

This function can be used when the workpiece coordinate system function is not provided.

7.2.3 Setting a Workpiece Coordinate System (Using G54 to G59)

Explanations

- **Setting a workpiece coordinate system**

Set six coordinate systems specific to the machine in advance. Then, select one of the six coordinate systems by using G54 to G59.

Format

$\left. \begin{array}{l} \mathbf{G54} \\ \mathbf{G55} \\ \mathbf{G56} \\ \mathbf{G57} \\ \mathbf{G58} \\ \mathbf{G59} \end{array} \right\} \mathbf{IP_};$	G54	Workpiece coordinate system 1
	G55	Workpiece coordinate system 2
	G56	Workpiece coordinate system 3
	G57	Workpiece coordinate system 4
	G58	Workpiece coordinate system 5
	G59	Workpiece coordinate system 6

Set the distance between the machine zero point and the zero point of each of the six coordinate systems (offset from the workpiece zero point) in advance.

There are two setting methods.

- **Using the MDI**
- **Using a program (See Section 7.4.)**

Workpiece coordinate systems 1 to 6 are established properly when return to the reference position is performed after power is turned on. Immediately after power is turned on, G54 is selected.

- **Shift of workpiece coordinate systems**

The six workpiece coordinate systems can be shifted by a specified amount (external offset from the workpiece zero point).

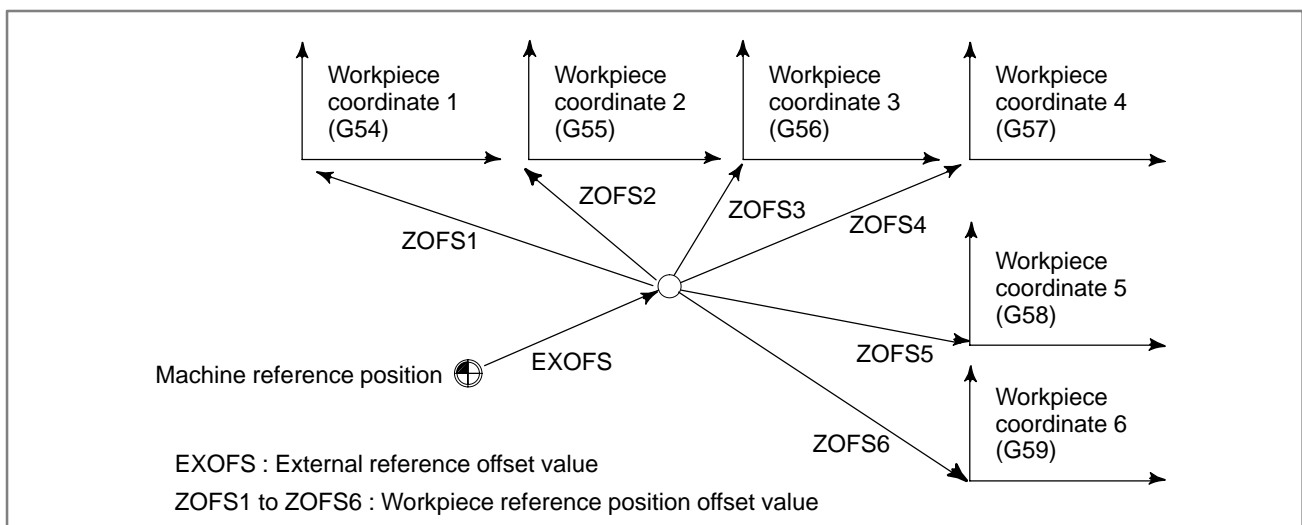

7.2.4 Counter Input in a Workpiece Coordinate System

Explanations

- **Inputting counter values in a workpiece coordinate system**

On the workpiece coordinate system screen, when an axis address is specified, then the [INP.C.] soft key is pressed, the relative coordinate value for the specified axis is set at the cursor position as workpiece coordinate system data.

Examples

When the cursor is positioned on the X-axis of the offset from the workpiece zero point (G54) with the following relative coordinates:

[Relative coordinates]	[Workpiece coordinate system G54]
X 100.000	X= 0.000 ←Cursor position
Y 200.000	Y= 0.000
Z 300.000	Z= 0.000

- (1) Inputting X then [INP.C.] sets X = 100.000.
- (2) Inputting Y then [INP.C.] sets X = 200.000.
- (3) Inputting Z then [INP.C.] sets X = 300.000.

7.3 LOCAL COORDINATE SYSTEM (G52)

With G52 commanded, the local coordinate system with the commanded position as zero point can be set. Once the local coordinate system is set, values specified in subsequent move commands are regarded as coordinate values on that coordinate system. Coordinates once set is valid till a new G52 is commanded. This is used when, for example, programming of a part of the workpiece becomes easier if there is a zero point besides the workpiece coordinates' zero point.

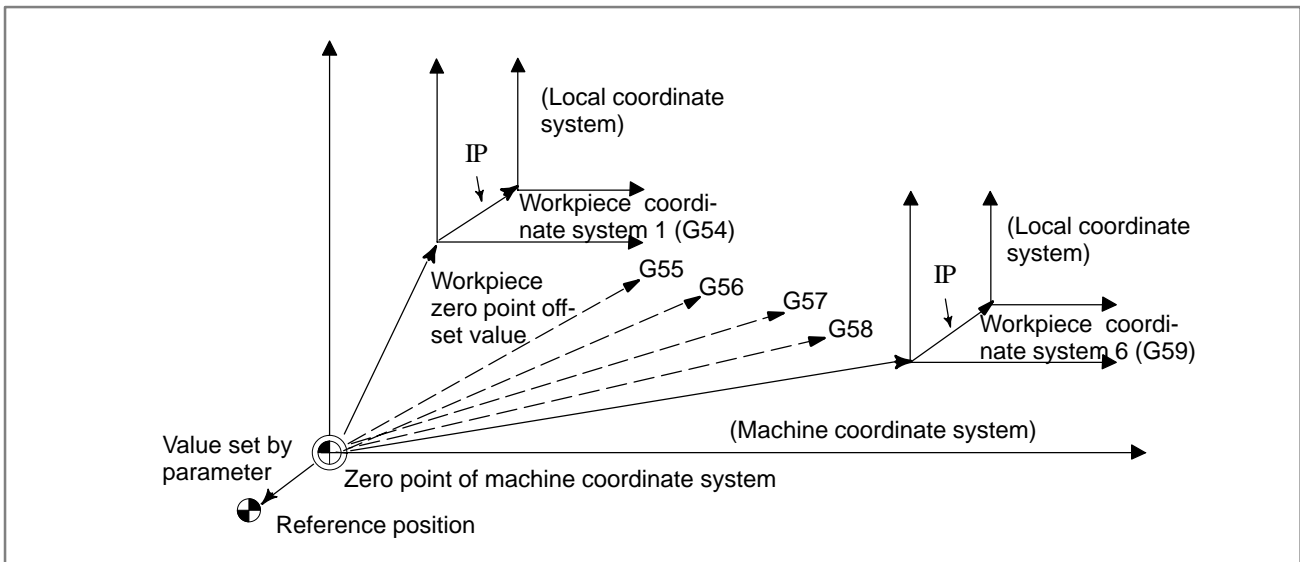

Format

G52 IP_ ;

Explanations

When local coordinate system is set, local coordinate system 1 - 6, corresponding to workpiece coordinate system 1 - 6 is set. Distance between zero points are all the same preset value.

If G52 IP0; is commanded, local coordinate system is canceled.

7.4 WORKPIECE ORIGIN OFFSET VALUE CHANGE (PROGRAMMABLE DATA INPUT) (G10)

G10 command is used to change workpiece origin offsets.

When G10 is commanded in absolute command (G90), the commanded workpiece origin offsets becomes the new workpiece origin offsets, and when G10 is commanded in incremental command (G91), the currently set workpiece origin offsets plus the commanded workpiece origin offsets becomes the new workpiece offsets.

Format

G10 L2 Pp IP _ ;

p : Specification the external workpiece origin offset value

p=1-6 : Specification the workpiece origin offset value corresponded to workpiece coordinate systems 1-6

IP : Workpiece origin offset value

7.5 ADDITIONAL WORKPIECE COORDINATE SYSTEMS

M series

Forty-eight workpiece coordinate systems can be added when existing six workpiece coordinate systems (G54 - G59) are not enough for the operation. Make a command as follows for selection of workpiece coordinate system.

Up to 300 additional workpiece coordinate systems can be used.

Format

G54.1 Pp IP _ ; or **G54 Pp IP _ ;**

P: 1-48 or 1-300 Number of the additional workpiece coordinate system

The following are the methods of setting and changing of the workpiece origin offset value as well as those used for the existing workpiece coordinate systems of G54 to G59.

- **Method via MDI**
- **Method via program**
 - G10L20Pp;
 - Custom macro

7.6 WORKPIECE COORDINATE SYSTEM PRESET (G92.1)

The workpiece coordinate system with its zero position away by the workpiece zero offset amount from the machine coordinate system zero position is set by returning the tool to the reference point by a manual operation. Also, when the absolute position detector is provided, the workpiece coordinate system is automatically set by reading the machine coordinate value from the detector when power on without performing manual reference point return operation. The set workpiece coordinate may shift by any of the following commands or operation:

- When manual interruption is performed with the manual absolute signal off
- When the travel command is performed by the machine lock
- When axis travel is performed by the handle interrupt or auto/manual simultaneous operation
- When operation is performed by mirror image
- When the setting of local coordinate system is performed by the G52 or change of workpiece coordinate system is performed by the G82

The workpiece coordinate system shifted by the above operation can be preset by the G code instruction or MDI operation the same as conventional manual reference point return.

Explanations

- **Workpiece coordinate system preset by G code command**

The workpiece coordinate system can be preset by commanding the

G92.1 IP 0 ;

IP 0 : The axis address to be preset the workpiece coordinate system
Uncommanded axis is not preset.

- **Workpiece coordinate system preset by MDI operation**

The workpiece coordinate system can be preset by the MDI operation with soft keys.

7.7 WORKPIECE COORDINATE SYSTEM SHIFT

T series

When the coordinate system actually set by the G50 command or the automatic system setting deviates from the programmed workpiece system, the set coordinate system can be shifted.

Set the desired shift amount in the workpiece coordinates system shift memory.

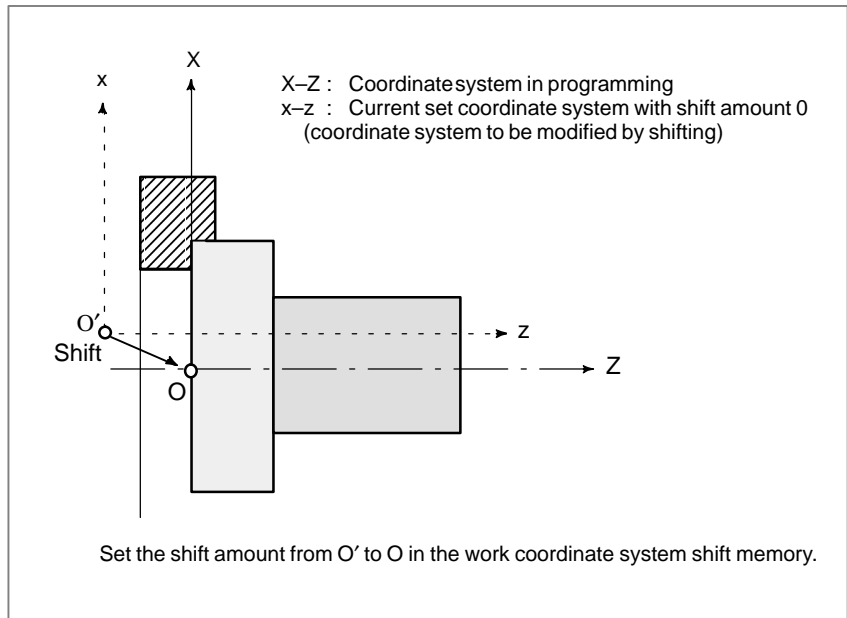

Workpiece coordinate system shift

7.8 PLANE SELECTION (G17, G18, G19)

A plane subject to circular interpolation, cutter compensation, coordinate system rotation, or drilling can be selected by specifying a G code.

G code	Selected plane	Xp	Yp	Zp
G17	Xp–Yp plane	X axis or an axis parallel to the X axis	Y axis or an axis parallel to the Y axis	Z axis or an axis parallel to the Z axis
G18	Zp–Xp plane			
G19	Yp–Zp plane			

Explanations

One of the existing parallel axes is determined by an axis address that appears in the block for which G17, G18, or G19 is specified.

• Example 1

When X and U, Y and V, and Z and W are parallel to each other, respectively

```
G17 X_ Y_ . . . . XY plane
G17 U_ Y_ . . . . UY plane
G18 X_ W_ . . . . WX plane
G18 U_ W_ . . . . WU plane
```

• Example 2

Planes remain unchanged in blocks for which G17, G18, or G19 is not specified.

```
G18 X_ Z_ . . . . ZX plane
X_ Y_ . . . . Plane not changed (ZX plane)
```

• Example 3

If G17, G18, or G19 is specified for a block, and no axis address is specified in that block, the axis addresses for the basic three axes are assumed to be omitted.

```
G17 . . . . . XY plane
G17 X_ . . . . . XY plane
G17 U_ . . . . . UY plane
```

NOTE

A parameter is used to specify which axis, X, Y, or Z the additional axis is parallel to. The move command functions regardless of the plane selection.

For example, suppose that the following is specified:

G17 Z_ ;

Axis Z does not exist on the XpYp plane. The XY plane is just selected, and the Z axis is moved regardless of the plane.

8

COORDINATE VALUE AND DIMENSION



8.1 ABSOLUTE AND INCREMENTAL PROGRAMMING (G90, G91)

There are two ways to command travels to the axes; the absolute command, and the incremental command. In the absolute command, coordinate value of the end point is programmed; in the incremental command, move distance of the axis itself is programmed.

G90 and G91 are used to command absolute or incremental command.

G90 : Absolute command

G91 : Incremental command

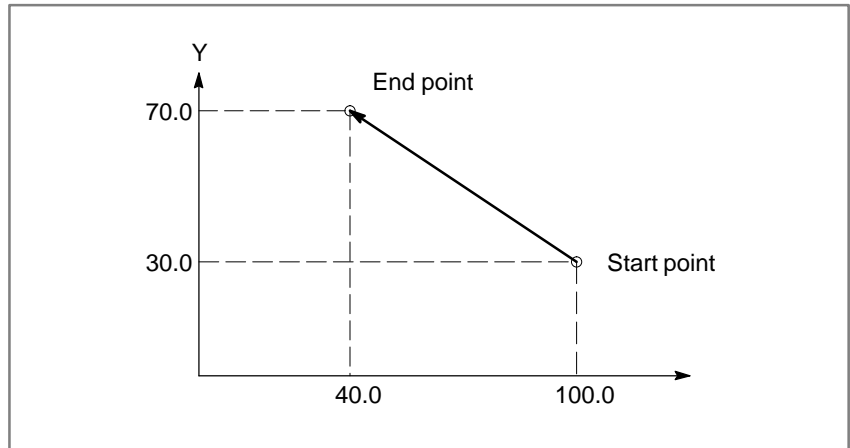

For the above figure, incremental command programming results in:

G91 X60.0 Y40.0 ;

while absolute command programming results in:

G90 X40.0 Y70.0 ;

Absolute/incremental command, when G code system A at T series is selected, is not distinguished by G90/G91 but is distinguished by the address word.

For the A and B axes, no incremental commands are provided.

Absolute command	Incremental command	Notes
X	U	X axis move command
Z	W	Z axis move command
Y	V	Y axis move command
C	H	C axis move command
A	None	A axis move command
B	None	B axis move command

Example

X_ W_ ;

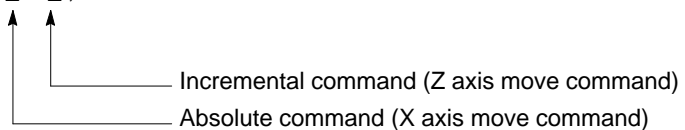

8.2 **M series** POLAR COORDINATE COMMAND (G15, G16)

The end point coordinate value can be input in polar coordinates (radius and angle). Use G15, G16 for polar coordinates command.

G15 : Polar coordinate system command cancel

G16 : Polar coordinate system command

Plane selection of the polar coordinates is done same as plane selection in circular interpolation, using G17, G18, G19.

Command radius in the first axis of the selected plane, and angle in the second axis. For example, when the X-Y plane is selected, command radius with address X, and angle with address Y. The plus direction of the angle is counter clockwise direction of the selected plane first axis + direction, and the minus direction the clockwise direction.

Both radius and angle can be commanded in either absolute or incremental command (G90, G91).

The center of the polar coordinates is the zero point of the workpiece coordinates. (However, if the local coordinates are set, it is the zero point of the local coordinates.)

Examples

● Bolt hole cycle

N1 G17 G90 G16;

Polar coordinates command, X-Y plane

N2 G81 X100. Y30. Z-20. R-5. F200.;

100mm radius, 30° angle

N3 X100. Y150;

100mm radius, 150° angle

N4 X100. Y270;

100mm radius, 270° angle

N5 G15 G80;

Polar coordinates cancel

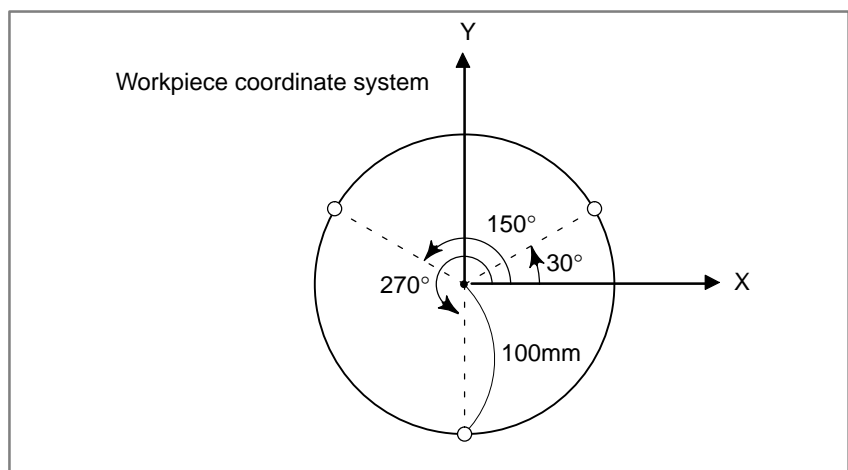

8.3 INCH/METRIC CONVERSION (G20, G21)

Conversion of inch and metric input can be commanded by the G code command.

G20 : Inch input

G21 : Metric input

Whether the output is in inch system or metric system is parameter-set when the machine is installed.

Command G20, G21 at the head of the program.

Inch/metric conversation can also be done by MDI setting.

The contents of setting data differs depending on whether G20 or G21 is commanded.

8.4 DECIMAL POINT INPUT/POCKET CALCULATOR TYPE DECIMAL POINT INPUT

Numerals can be input with decimal points. Decimal points can be used basically in numerals with units of distance, speed, and angle. The position of the decimal point is at the mm, inch, deg position.

There are two types of decimal point notation: calculator-type notation and standard notation.

When calculator-type decimal notation is used, a value without decimal point is considered to be specified in millimeters, inch or deg. When standard decimal notation is used, such a value is considered to be specified in least input increments.

Use parameters to select input method; whether to input by pocket calculator type input, or by the usual decimal point input.

Values can be specified both with and without decimal point in a single program.

Program command	Pocket calculator type decimal point programming	Usual decimal point programming
X1000 Command value without decimal point	1000mm Unit : mm	1mm Unit : Least input increment (0.001 mm)
X1000.0 Command value with decimal point	1000mm Unit : mm	1000mm Unit : mm

8.5 DIAMETER AND RADIUS PROGRAMMING

T series

Since the work cross section is usually circular in latches, its dimensions can be specified in two ways when performing a thing:

When the diameter is specified, it is called diameter programming, and when the radius is specified, it is called radius programming.

The diameter programming or radius programming can be selected by parameter for each axis.

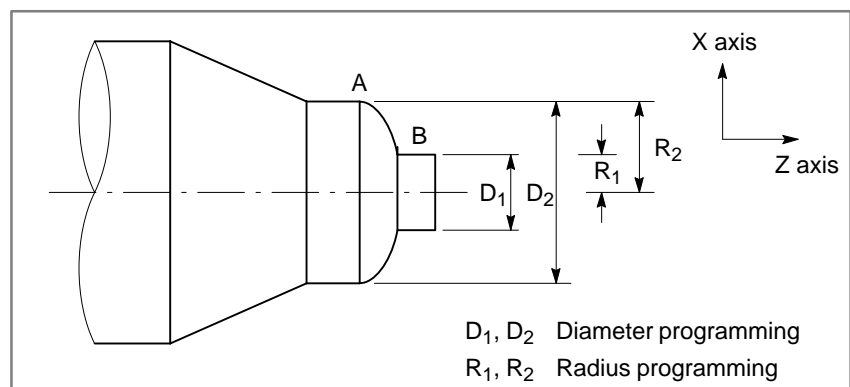

8.6 LINEAR AXIS AND ROTATION AXIS

A linear axis refers to an axis moving linearly, and for it values are specified in mm or inches.

A rotation axis refers to a rotating axis, and for it values are specified in degrees.

For rotation axes, note the following:

- Inch-metric switching is not performed.
- The machine coordinate system is always normalized to the range from 0deg to 360deg.

8.7 ROTATION AXIS ROLL-OVER FUNCTION

The rotation axis roll-over function rounds the absolute coordinate value and relative coordinate value of a rotation axis to a coordinate value within one rotation. This prevents coordinate values to overflow.

In an incremental command, the specified value is regarded as the amount of travel.

In an absolute command, the specified value is rounded to within one rotation. The resulting coordinate value is used as the end point. A parameter is used to specify whether to determine the move direction by the sign of the specified value or by the move distance (the shortest move distance to the end point is selected).

8.8 ROTARY AXIS CONTROL

When an absolute command is specified for a rotary axis for which the rollover function is set, the tool moves in the direction indicated by the sign of the specified value, and the coordinates of the end point become the specified absolute values.

9

SPINDLE FUNCTIONS



9.1**S CODE OUTPUT**

Specify the spindle speed with up to five digits immediately after address S. The 5-digit numeric value is output to the PMC as a 32-bit binary code. The code is maintained until another S is specified. The maximum number of input digits for S can be specified using a parameter.

9.2**SPINDLE SPEED
ANALOG OUTPUT
(S ANALOG OUTPUT)**

The speed of the analog interface spindle is controlled. Specify the spindle speed with up to five digits immediately after address S. According to the specified spindle speed, a speed command is output to the spindle motor in a form of analog voltage. During constant surface speed control, an analog voltage is output so that it matches the spindle speed reached after constant surface speed control.

9.3**SPINDLE SPEED
SERIAL OUTPUT
(S SERIAL OUTPUT)**

The speed of the serial interface spindle is controlled. Specify the spindle speed with up to five digits immediately after address S. A speed command is output to the spindle motor according to the specified spindle speed. During constant surface speed control, a speed command is output so that it matches the spindle speed reached after constant surface speed control.

9.4**SPINDLE OUTPUT
CONTROL BY THE
PMC**

If a speed command for the spindle motor is input in a form of [sign + 12-bit binary code], the command is output to the spindle motor according to the input.

9.5 CONSTANT SURFACE SPEED CONTROL

Whether to perform constant surface speed control is specified using G96 or G97.

G96 : Constant surface speed control mode

G97 : Constant surface speed control cancel mode

If the surface speed is specified with an S code (S followed by a numeric value) in the constant surface speed control mode, the spindle speed is controlled so that a constant surface speed can be maintained while the tool position is changing.

The axis on which the calculation for constant surface speed control is based can be specified with either a parameter or the following command:

G96 P α ; P0 : Axis specified with a parameter

P α : α th axis ($\alpha = 1$ to 8)

The specifiable range of the S code is as follows:

1 to 99999 m/min or feet/min

In the constant surface speed control cancel mode, the spindle speed is specified using an S code.

In the constant surface speed control mode, a constant surface speed control on signal is output.

By specifying the following command, the maximum spindle speed can be set:

G50 S_ ; (with the G code system A in T series)

or

G92 S_ ; (where, S-- is the maximum spindle speed in min^{-1})

The spindle speed is clamped when it reaches the specified maximum spindle speed.

Generally, a machine that does not have (or which does not use) a position coder cannot perform feed per rotation under constant surface speed control. When a certain parameter is set, such a machine can perform feed per rotation under constant surface speed control, assuming that S 12-bit code signals R01O to R12O represent a specified spindle speed. (Constant surface speed control without a position coder: T series only)

9.6 SPINDLE OVERRIDE

To the spindle speed specified by S, an override from 0% to 254% can be applied (in steps of 1%).

9.7 T series ACTUAL SPINDLE SPEED OUTPUT

Actual spindle speed calculated by the return pulses of the position coder on the spindle is output in 16-bit binary code.

9.8 SPINDLE POSITIONING

T series

In turning operation, the spindle connected to the spindle motor rotates at a certain speed, and the workpiece attached to the spindle is then turned. The spindle positioning function moves the spindle connected to the spindle motor by a given angle so that the workpiece attached to the spindle is positioned at a desired angle.

With this function, any portion of the workpiece can be drilled.

The spindle position is detected by the position coder attached to the spindle.

Whether to use the spindle for spindle positioning (spindle positioning mode) or to use the spindle for spindle rotation (spindle rotation mode) is command by special M code (set by parameters).

- **Move command**

When commanded:

G00 C_ ;

The spindle is positioned to the commanded position by rapid traverse. Absolute (G90) and incremental (G91) command, as well as decimal point input is possible.

- **Increment system**

Least input increment: 0.001 deg.

Detection unit: $(360 \times N) / 4096$ deg.

N: Combination ratio of position coder and spindle (N=1, 2, 4)

9.9 SPINDLE SPEED FLUCTUATION DETECTION (G25, G26)

This function monitor spindle speed, detects a higher level of fluctuation than the commanded speed and signals an abnormality, if any, to the machine side, using an alarm, thereby preventing the spindle from seizure, for example. Whether the spindle speed fluctuation detection is done or not is specified by G code.

G25 : Spindle speed fluctuation detection is off.

G26 : Spindle speed fluctuation detection is on.

Format

G26 P_ Q_ R_ ;

P_ : Time from the change of spindle speed to the start of the spindle speed fluctuation detection (Unit: msec)

Q_ : The ratio of spindle speed to the specified spindle speed where spindle speed fluctuation detection starts (Units: %)

R_ : Fluctuation ratio regarded as an alarm (Unit: %)

NOTE

- 1 The value of P, Q, and R remains after the power off.
- 2 The actual spindle speed is calculated by the return pulses generated from the position coder attached to the spindle.

Explanations

There are two ways in generating an alarm:

An alarm is generated before the specified spindle speed reaches.

An alarm is generated after the specified spindle speed reaches.

- When an alarm is generated after the spindle speed becomes the commanded speed.

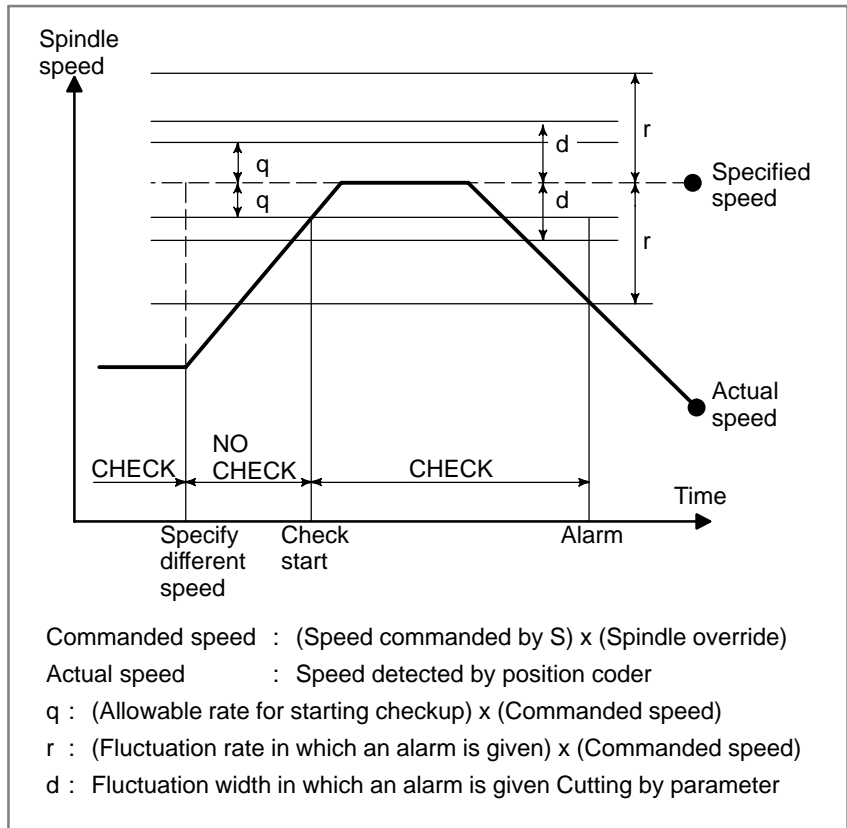

- When an alarm is generated before the spindle speed becomes the commanded speed.

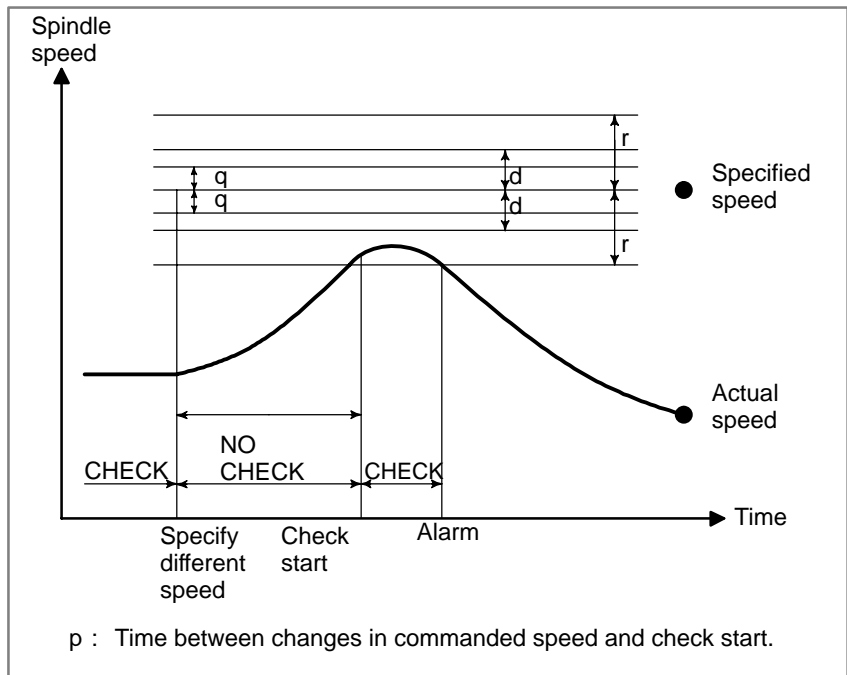

9.10 Cs CONTOUR CONTROL

Explanations

- **Control mode**

The serial interface spindle permits positioning and linear interpolation with another servo axis. Thus, linear interpolation between the spindle and a servo axis can be specified.

The serial interface spindle has two modes.

- The spindle rotation control mode controls the speed of the spindle. (The spindle is rotated according to a speed command.)
- The spindle contour control mode (also called Cs contour control) controls the position of the spindle. (The spindle is rotated according to a move command.)

These modes are switched by a signal sent from the PMC.

- **Spindle contour control axis**

The axis subject to spindle contour control is placed as one of the CNC control axes. Any of the control axes can be selected as the spindle contour control axis.

- **Move command**

In manual and automatic operation, a move command for the spindle contour control axis is programmed in the same way as for a servo axis.

Example) Let the name of the spindle contour control axis be C.

G00 C30.0 ; (Positioning)

G01 X100.0 Y100.0 C90.0 F1000.0 ; (Linear interpolation)

- **Automatic loop gain setting when switching between spindle rotation control and spindle contour control is made**

- Switching from spindle rotation control to spindle contour control**

If there is a difference in servo loop gain between the axis subject to spindle contour control and the other servo axes, linear interpolation with the spindle contour control axis cannot be performed properly. As soon as spindle rotation control is switched to spindle contour control, an appropriate spindle contour control servo loop gain for a selected gear is automatically set for a necessary servo axis. The axis for which the servo loop gain is to be changed, and the spindle contour control servo loop gain for this axis must be set in parameters for each gear beforehand.

- Switching from spindle contour control to spindle rotation control**

As soon as spindle contour control is switched to spindle rotation control, the original servo loop gain is set for the servo axis automatically.

9.11 MULTI-SPINDLE CONTROL

Up to four spindles can be controlled. The three spindles are called the first, second, third, and fourth spindles. The first and second spindles are made up of serial interface spindles, and the third spindle is of an analog interface spindle. (The second or third spindle may be omitted from the configuration.)

If no analog interface spindle is used, all the first to fourth spindles are configured with serial interface spindles.

A spindle speed is specified with a 5-digit numeric value following S. This command functions on the spindle selected by spindle selection signals (SWS1 to SWS4). More than one spindle can be selected so that they can be rotated at the same time by specifying the same command. Each spindle holds a specified command (spindle speed). When the spindle is not selected by the spindle selection signal, the spindle rotates at the held spindle speed. By using this feature, the spindles can be rotated at different speeds at the same time. For each spindle, a signal to stop spindle rotation is provided (*SSTP1 to *SSTP4). With these signals, unnecessary spindles can be placed in the stopped state.

Feedback pulses from the position coders connected to the first and second spindles can be input to the CNC to perform threading and feed per rotation. One of the position coders connected to the first and second spindles is selected by a signal. The feedback pulse from the selected coder is then input to the CNC. From the third spindle, no feedback pulse can be input.

The multi-spindle control functions of the M and T series differ as follows:

- For the M series, multi-spindle control is possible only when spindle gear selection type T is specified.
- For the M series, rigid tapping spindle selection signals (RGTSP1, RGTSP2, and RGTSP3) cannot be used.
- When two-path control is performed with the M series, spindle commands and position coder feedback signals cannot be changed between the paths (spindle command select signals SLSPA and SLSPB, and spindle feedback select signals SLPCA and SLPCB are not supported).

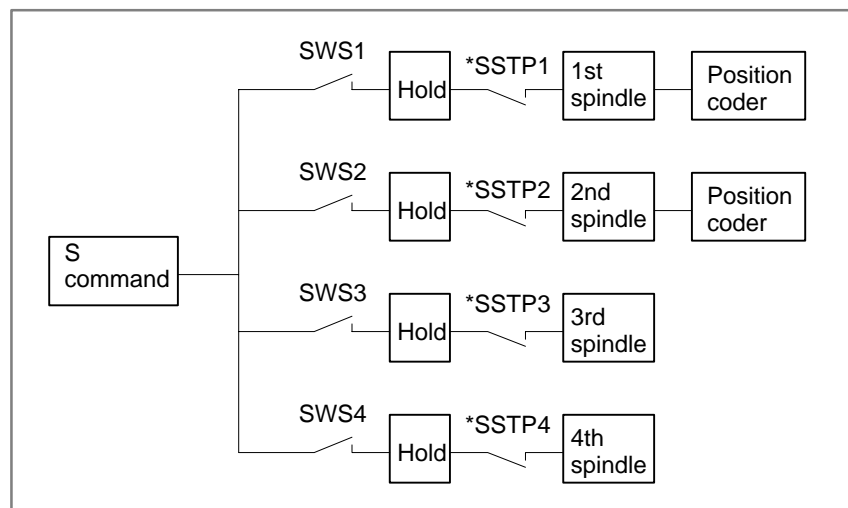

9.12 SPINDLE SYNCHRONIZATION CONTROL

In machine tools having two spindles (such as a lathe), the speeds of the two spindles sometimes have to match. This requires when a workpiece held on the first spindle is transferred to the second spindle while the spindles are rotating, and when acceleration/deceleration is performed while a workpiece is being held by the first and second spindles.

When a workpiece having a different figure is transferred between the spindles, the rotation phases (rotation angles) of the spindles must also match.

The serial interface spindle synchronization control function is provided to provide synchronization control for two spindles.

9.13 SPINDLE ORIENTATION

You can perform spindle orientation simply by mounting a position coder on the spindle. Stoppers or pins for physically stopping the spindle at a specified position are not necessary. A spindle can be instantly oriented, even when rotating at high speed, thereby greatly reducing the orientation time.

9.14 SPINDLE OUTPUT SWITCHING

Spindle output switching switches between the two windings, one for low speed and the other for high speed, incorporated into the special spindle motors. This ensures that the spindle motor demonstrates stable output characteristics over a wide range.

9.15 THREE/FOUR -SPINDLE SERIAL OUTPUT

When one-path control or two CPUs with two-path control is performed, up to four serial spindles can be connected.

The third serial spindle operates as an ordinary third analog spindle. For the third, as well as the first and second serial spindles, all the functions supported by the serial spindle control unit (spindle orientation, spindle output switching, and spindle switching) can be used.

When the third spindle orientation function is used, stop-position external-setting type orientation can also be performed for the third spindle.

When the fourth spindle orientation function is used, stop-position external-setting type orientation can also be performed for the fourth spindle.

9.16 SIMPLE SPINDLE SYNCHRONOUS CONTROL

In simple spindle synchronous control mode, the second spindle can be controlled as a slave axis of the first spindle.

Thus, control based on the Cs contour axis control function, rigid tapping function, and spindle positioning function (T series) can be exercised over the second spindle, under the control of the first spindle.

Note, however, that unlike spindle synchronous control, simple spindle synchronous control does not guarantee synchronization between the first and second spindles.

To realize simple spindle synchronous control, two serial spindle systems, both of which support two-spindle connection, are required. Moreover, both spindles must be fitted with the spindle-related hardware, such as detectors, required for the functions used with simple spindle synchronous control (Cs contour axis control function, rigid tapping function, and spindle positioning function (T series)).

9.17 SERIAL SPINDLE ADVANCED CONTROL

The advanced feedforward control function can be made usable for serial interface spindles. This makes rigid tapping, Cs contour axis control (for the first axis only), and spindle positioning (T series) usable even in the advanced control mode.

Because the fine acceleration/deceleration (FAD) function cannot be applied to the serial interface spindle, however, it cannot be used for the servo axis if advanced control is applied to the serial interface spindle.

9.18 SPINDLE POSITION DATA DISPLAY

Appropriate parameter setting causes the current position coder position (the number of pluses) to be displayed with a precision of 4096 per rotation on the diagnosis screen.

This data can be used to determine the current position of the spindle.

10 TOOL FUNCTIONS



10.1 T CODE OUTPUT

M series

A tool can be selected by specifying a tool number of up to eight digits immediately after address T. The tool number is output to the PMC in a 32-bit binary code. This code is kept till the next T code is commanded. Maximum input digits are set by parameters.

T series

A tool and offset can be selected by specifying a tool number and offset number of up to eight digits (in total) immediately after address T. The offset number is specified with the last one or two digits of the T code. The tool number is specified with the remaining digits after excluding the one or two digits used to specify the offset number.

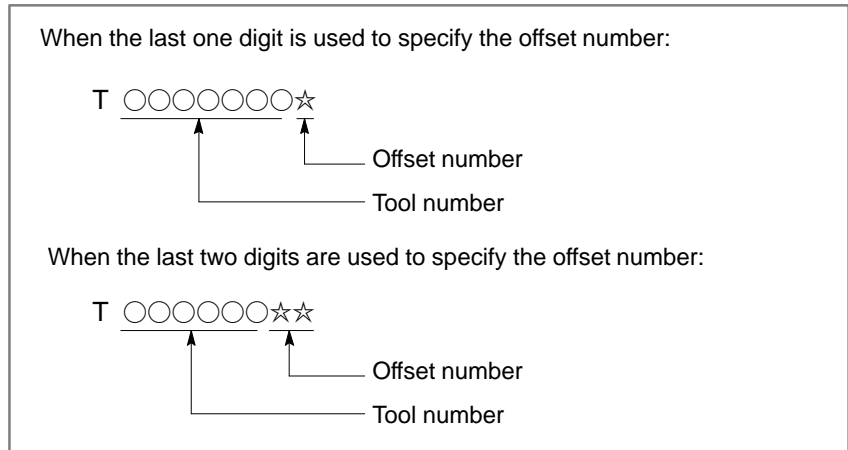

The tool number is output in a 32-bit binary code. This code is kept till the next T code is commanded. Maximum input digits are set by parameters.

10.2 TOOL LIFE MANAGEMENT

10.2.1 Tool Life Management

Tools are classified into groups, and tool life (hours and times of use) is set for each group. When use of the tool exceeds the preset hours or times of use, another tool in the same group which has not yet exceeded the preset life time is selected. If all the tool in a group exceeds the preset life time, a signal is output to inform the operator that the tools must be changed to new tools. With setting the cutter radius compensation number and the tool length compensation number of the tools, compensation corresponding to each tool can also be done. (M series) With use of this function Factory Automation (FA) comes to a reach. This function has the following features:

- Tool life can be set in hours or times of use.
- **New tool select signal output**
This signal is output when a new tool is selected in a group. This can also be used for automatic measurement in compensations of the new tools.
- **Tool change signal**
When all the tools of a group has exceeded their life time, this signal is output to inform the operator.
- **Tool skip signal**
By inputting this signal, tools still not exceeding their life time, can also be changed.
- **Tool life management data is display/modification**
Tool life management data is displayed on the LCD screen, informing the operator of the condition of the tools at a single view. If necessary, the counter value of tool life can be modified via the MDI panel. Number of groups and number of tools per group is selected by parameter from the following.

M series		T series	
Number of groups	Number of tools	Number of groups	Number of tools
16	16	16	16
32	8	32	8
64	4	64	4
128	2	—	—

10.2.2 Addition of Tool Pairs for Tool Life Management <512 Pairs (M series) / 128 Pairs (T series)>

The number of groups that can be registered in the tool life management function and the allowable number of tools per group can be selected from the following four combinations. One of the combinations is selected using a parameter.

M series		T series	
Number of groups	Number of tools	Number of groups	Number of tools
64	16	16	32
128	8	32	16
256	4	64	8
512	2	128	4

10.2.3 **M series** Extended Tool Life Management

The following features are added to the tool life management function for easier handling:

- Setting tool life management data for each tool group by program**
 Addition, modification, and deletion can be made to only the tool life management data of a specified group; the tool life management data of the other groups is left intact.
 A tool life is set for each tool group by time or use count.
- Displaying and editing tool life management data**
 All tool life management data is displayed on the screen, and so the user can understand the current tool state instantly. The following data items are displayed:
 - Tool group number of the tool currently used
 - Tool group number selected next
 - Tool life management data
 - Life, life counter value
 - List of tool numbers in the group
 - Cutter compensation number and tool length compensation corresponding to each tool number
 - Use state for each tool (for example, indicating whether tool life is reached)

Tool life management data can be modified at the MDI panel. In addition, tool numbers can be added, changed, and deleted.

- Life count override**
 If a tool life is set by time, actual time obtained by multiplying the use time of a tool by a magnification (override value) can be added to the life counter. An override value from 0 to 99.9 is specified in steps of 0.1 by a signal sent from the PMC.

Example)

If the override value is 0.1, and the use time of a tool is ten minutes, the life counter is incremented by one minute.

10.3 TOOL LIFE MANAGEMENT B

M series

- **Tool life notice signal**

When the rest of the tool life (remainder value) until a new tool is selected is set as a value common to all groups, a signal is output to the PMC when the value obtained by the subtraction (the life value (LIFE) minus the counter value (COUNT)) has reached the set remainder value.

With tool life management B, the features of the conventional tool life management function have been expanded as follows:

- **Expanded life value**

In the conventional tool life management function, the maximum life count and time were 65535 times and 4300 minutes, respectively. When the tool life management B option is used, the maximum life count and time can be extended to 999999 and 100000 minutes, respectively.

- **Support of setting of arbitrary tool group numbers**

In the conventional tool life management function, the T code to specify a target group for tool life management was the tool life management ignore number plus group number. In tool life management B, use of the function for setting arbitrary tool group numbers (bit 5 of parameter No. 6802) allows an arbitrary T code to be used to specify a group.

- **Tool life notice signal expansion**

In the conventional tool life management function, the tool life notice signal was able to be used to set the rest of the tool life until the selection of a new tool only as a value common to all groups. With tool life management B, this value can be set for each group.

11

MISCELLANEOUS FUNCTIONS



11.1 MISCELLANEOUS FUNCTIONS

When up to eight digits immediately after address M are specified, a 32-bit binary code is output. The maximum number of input digits can be specified with a parameter. This binary code is used for on/off control of the machine. A block can usually contain up to three M codes although only one of them is effective.

The following M codes are used for special purposes:

- M00 : Program stop
- M01 : Optional stop
- M02 : End of program
- M30 : End of program and tape rewind

The above M codes can also be output in binary codes.

M98 (sub program call) and M99 (return from sub program) and always processed in the CNC so, signal will not be output.

11.2 1-BLOCK PLURAL M COMMAND

Up to three M codes can be simultaneously specified in one block.

As these M codes are simultaneously sent to PMC side, the machining cycle time compared with the conventional 1-block single M command is reduced.

Example)

(i) **1-block single M command**

```
M40;
M50;
M60;
G28G91X0Y0Z0;
:
```

(ii) **1-block plural M command**

```
M40M50M60;
G28G91X0Y0Z0;
:
```

NOTE

- 1 The maximum input value of the first M code is 99999999, while the maximum input values of the second and third M codes are 65535.
- 2 A strobe signal is provided for each of the first to third M codes (MF, MF2, and MF3).
When all the operations for the first to third M codes are completed, completion signal FIN is output.

11.3 SECOND MISCELLANEOUS FUNCTIONS

When an 8-digit number after address B is commanded, a 32-bit binary code is output to the PMC. This code is kept till the next B code is commanded.

11.4 HIGH-SPEED M/S/T/B INTERFACE

The communication of execution command signal (strobe signal) and completion signal is the M/S/T/B function were simplified to realize a high-speed execution of M/S/T/B function.

The time required for cutting can be minimized by speeding up the execution time of M/S/T/B function.

The following describes an example of auxiliary function M code command. The same applies to the T, S, and B (second auxiliary function) functions.

When an M code is specified, the CNC inverts the logical level of strobe signal MF. Thus, when the signal is 0, it becomes 1. When it is 1, it becomes 0. After inverting strobe signal MF, the CNC assumes the completion of PMC operation once the logical level of completion signal MFIN from PMC has become the same as the logical level of strobe signal MF.

In the usual system, if the leading edge (from "0" to "1") of the completion signal FIN of M/S/T/B is received and then the trailing edge (from "1" to "0") of the signal FIN is received, it is considered that the operation has been completed. However, in this system, the operation is considered to have been completed by a single change of completion signal MFIN.

Example) M10;
M20;

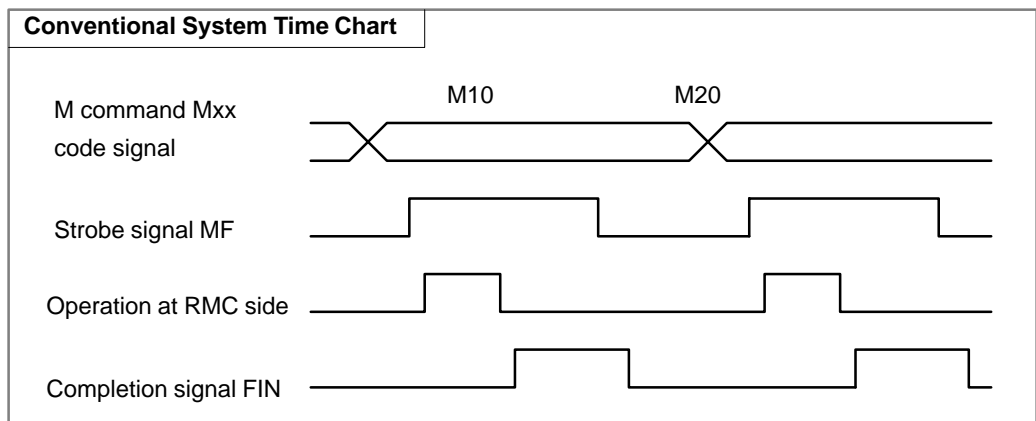
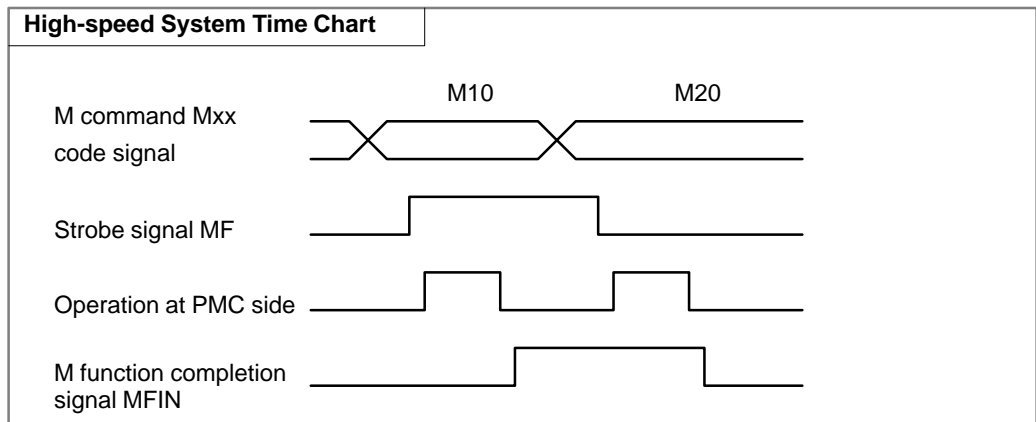

NOTE

- 1 Either the conventional system or the high-speed system can be selected for communication of strobe signal and completion signal.
- 2 In the conventional system, only one completion signal is available for all functions of M/S/T/B. However, in the high-speed system, one completion signal is available for each of M/S/T/B functions.

11.5 M CODE GROUP CHECK FUNCTION

The M code group check function checks if a combination of multiple M codes (up to three M codes) contained in a block is correct.

This function has two purpose. One is to detect if any of the multiple M codes specified in a block include an M code that must be specified alone. The other purpose is to detect if any of the multiple M codes specified in a block include M codes that belong to the same group.

12 PROGRAM CONFIGURATION



12.1 PROGRAM NUMBER

A program number is given to each program to distinguish a program from other programs. The program number is given at the head of each program, with a 4-digit number (when the 8-digit program number option is used, however, eight digits following address O) after the address O. Program number of the program currently under execution is always displayed on the LCD screen. Even during the execution of a sub program, the program number of the main program can also be displayed by parameter setting. Program search of programs registered in the memory is done with the program number. The program number can be used in various ways.

12.2 PROGRAM NAME

A program name can be given to the program to distinguish the program from other programs when displaying all the registered program on a screen. Register the name between the control-out and the control-in. Any codes usable in the CNC can be used for the program name. The program name is displayed with the program number in the directory display of registered programs. Note that the program name displayed is within 31 characters.

Example) 01234 (PROGRAM FOR ATC);

12.3 MAIN PROGRAM

A program is divided into the main program and the sub program. The CNC normally operates according to the main program, but when a command calling a sub program is encountered in the main program, control is passed to the sub program. When a command indicating to return to the main program is encountered in the sub program, control is returned to the main program.

12.4 SUB PROGRAM

When there are fixed sequences or frequently repeated patterns in a program, programming can be simplified by entering these pattern as sub programs to the memory. Sub program is called by M98, and M99 commands return from the sub program. The sub program can be nested 4 folds.

A sequence number in a sub program can also be specified for sub program call.

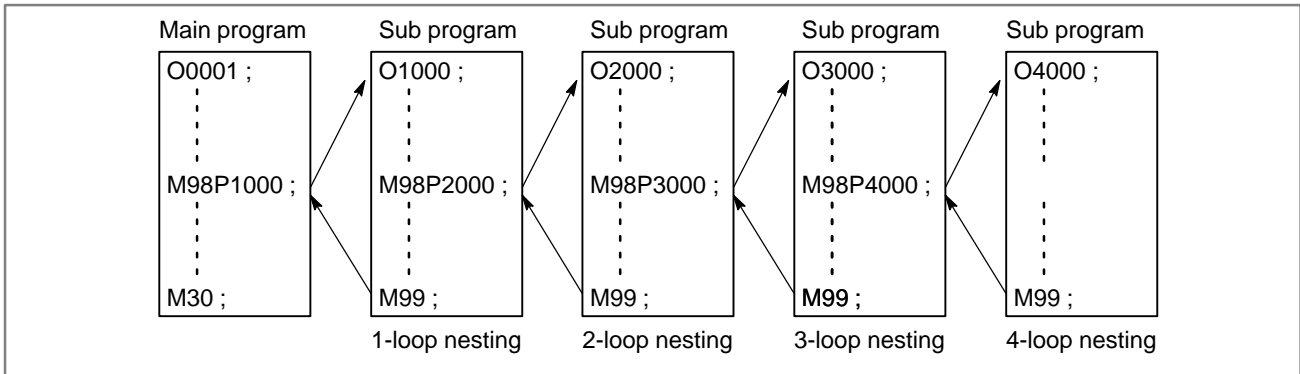

Format

Sub program call

M98 P ○○○ ○○○○ **Q** ○○○○○ ;

↑ ↑ ↑

Number of repetitive Subprogramnumber Sequencenumber
calls

If the number of repetitive calls is omitted, 1 is assumed.

When Q and a sequence number are omitted, the beginning of the sub program is called.

Return from sub program

M99 ;

12.5 EXTERNAL MEMORY AND SUB PROGRAM CALLING FUNCTION

When memory is used, a program cataloged in the floppy cassette or memory card can be called and executed as a sub program.

A sub program is called from the floppy cassette or memory card when the program using the memory executes the following block.

Format

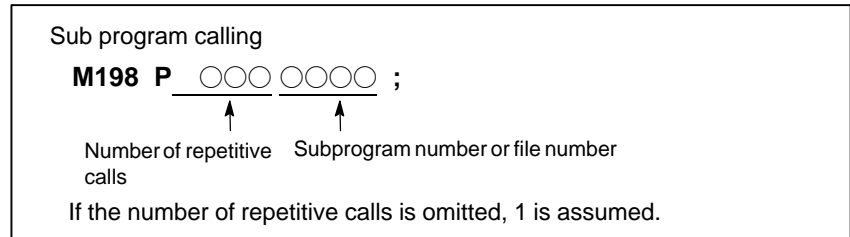

NOTE

- 1 Whether address P specifies the file number or program number is selected by a parameter.
- 2 In the program called by M198, no more sub program can be called by M198.

12.6 SEQUENCE NUMBER

Sequence number can be given in a 5-digit number after the address N at the head of the program block.

The sequence number of the program under execution is always displayed on the screen. The sequence number can also be searched in the program by the sequence number search function.

12.7 TAPE CODES

Either the EIA or the ISO code can be used as tape code. The input program code is distinguished with the first end of block code (EIA: CR, ISO: LF). See the List of Tape Codes for tape codes used.

12.8 BASIC ADDRESSES AND COMMAND VALUE RANGE

- **Basic Addresses and Range of Values to Be Specified (M series)**

The following table shows the basic addresses and the range of values to be specified. The range, however, is that of CNC. Note that the range of the machine is different from this.

Function		Address	Metric input	Inch input
Program number		O (Note1)	1-9999 1-99999999 (Note3)	1-9999 1-99999999 (Note3)
Sequence number		N	1-99999	1-99999
Preparatory function		G	0-999	0-999
Dimension word, Setting unit	IS-B	X, Y, Z, Q, R, I, J, K, A, B, C, U, V, W	±99999.999mm ±99999.999deg	±9999.9999inch (Note2) ±99999.999deg
	IS-C		±99999.999mm ±99999.999deg	±9999.9999inch (Note2) ±9999.9999deg
Feed per minute, Setting unit	IS-B	F	1-240000mm/min	0.01-9600.00inch/min
	IS-C		1-100000mm/min	0.01-4000.00inch/min
Feed per rotation, Setting unit		F	0.01-500.00mm/rev	0.0001-9.9999inch/rev
Spindle function		S	0-20000	0-20000
Tool function		T	0-99999999	0-99999999
Miscellaneous function		M	0-99999999	0-99999999
		B	0-99999999	0-99999999
Dwell, Setting unit	IS-B	X, P	0-99999.999 (sec or rev)	0-99999.999 (sec or rev)
	IS-C		0-9999.9999 (sec or rev)	0-9999.9999 (sec or rev)
Program number specification		P	1-9999	1-9999
Number of repeats		P	1-999	1-999
Offset number		H, D	0-400	0-400

● **Basic Addresses and Range of Values to Be Specified (T series)**

Function		Address	Metric input	Inch input
Program number		O (Note1)	1-9999 1-99999999 (Note3)	1-9999 1-99999999 (Note3)
Sequence number		N	1-99999	1-99999
Preparatory function		G	0-999	0-999
Dimension word, Setting unit	IS-B	X, Y, Z, U, V, W, A, B, C, I, J, K, R	±99999.999mm ±9999.9999deg	±9999.9999inch (Note2) ±99999.9999deg
	IS-C		±99999.999mm ±9999.9999deg	±999.99999inch (Note2) ±9999.9999deg
Feed per minute, Setting unit	IS-B	F	1-240000mm/min	0.01-9600.00inch/min
	IS-C		1-100000mm/min	0.01-4000.00inch/min
Feed per rotation, Screw lead		F	0.0001-500.000 mm/rev	0.000001-9.99999 inch/rev
Spindle function		S	0-20000	0-20000
Tool function		T	0-99999999	0-99999999
Miscellaneous function		M	0-99999999	0-99999999
		B	0-99999999	0-99999999
Dwell, Setting unit	IS-B	P, X, U	0-99999.999 (sec or rev)	0-99999.999 (sec or rev)
	IS-C		0-9999.9999 (sec or rev)	0-9999.9999 (sec or rev)
Program number specification		P	1-9999	1-9999
Number of repeats		P	1-999	1-999
Sequence number specification		P, Q	1-99999	1-99999

NOTE

- 1 “.” can be used for 0 in ISO Code.
- 2 Coordinates maximum command value for inch input/metric output is limited to: ±3937.0078 inch (IS-B)/ ±393.70078 inch (IS-C).
- 3 The 8-digit program number option is required.

12.9 TAPE FORMAT

The variable block word address format with decimal point is adopted as tape format. See List of Tape Format in Appendix C for details on tape formats.

12.10 LABEL SKIP

Label skip function is valid in the following cases, and “LSK” is displayed on the screen.

- When power is put on.
- When the NC is reset.

When label skip function is in valid, all codes to the first encountered end of block (EOB) code are ignored.

The ignored part is called “Reader part”, and section after the first end of block (EOB) code, “significant information”.

12.11 CONTROL-IN/ CONTROL-OUT

Information between the control-in and the control-out are regarded as notes and are ignored.

The reset codes (ISO code: %, EIA code: ER) cannot be used in this part. The ignored part is called “Notes”.

	ISO code	EIA code
Control-out	(Channel 2-4-5 on
Control-in)	Channel 2-4-7 on

12.12 OPTIONAL BLOCK SKIP

When a slash and number (/n) is programmed at the head of a program, and when the machine is operated with the optional block skip switch n on the machine operator’s panel on, information in the block commanded with the /n corresponding to the switch number n is ignored.

If the optional block skip switch n is turned off, information in the /n commanded block will not be ignored. The block with /n commanded can be skipped by the operator’s selection.

I can be used for n. The 1 to /1 can be omitted.

Example) /1 N12345 G00 X100.Z200.;

12.13 ADDITIONAL OPTIONAL BLOCK SKIP

2 to 9 can also be used for the n of the /n.

12.14 TAPE HORIZONTAL (TH) PARITY CHECK AND TAPE VERTICAL (TV) PARITY CHECK

A parity check is made on the number of punch holes for each input tape character. If the parity does not match, an alarm occurs (TH check). A parity check is made on each input data block. If the number of characters in one block (from the code next to EOB to another EOB) is odd, an alarm occurs (TV check). The TH or TV check cannot be made on the area skipped by the label skip function. The TH check is not made on the command field. A parameter can be used to specify whether the characters constituting comments are to be counted when obtaining the number of characters for TV check. The TV check function is validated or invalidated according to the value set on the MDI panel.

13

FUNCTIONS TO SIMPLIFY PROGRAMMING



13.1 **M series**
CANNED CYCLES
(G73, G74, G76,
G80-G89, G98, G99)

Canned cycle is a function to simplify commands for machining (boring, drilling, or tapping, etc). The canned cycle has the positioning plane and the drilling axis. The positioning plane is specified with the plane selection of G17, G18, and G19. The drilling axis is the basic axis X, Y or Z (that does not compose the positioning plane) or its parallel axis.

G code	Positioning plane	Drilling axis
G17	Xp-Yp plane	Xp
G18	Zp-Xp plane	Yp
G19	Yp-Zp plane	Zp

Xp : X axis or its parallel axis

Yp : Y axis or its parallel axis

Zp : Z axis or its parallel axis

The drilling axis address commanded in the same block as the G codes, G73 - G89, decides whether the drilling axis is the basic axis or its parallel axis. If the drilling axis address was not commanded, the basic axis becomes the drilling axis.

Axis other than the drilling axis becomes the positioning axis.

Example)

When U, V, W axes are set as parallel axes for X, Y, Z axes respectively.

G17G81 Z_ ; Drilling axis is Z axis.

G17G81 W_ ; Drilling axis is W axis.

G18G81 Y_ ; Drilling axis is Y axis.

G18G81 V_ ; Drilling axis is V axis.

G19G81 X_ ; Drilling axis is X axis.

G19G81 U_ ; Drilling axis is U axis.

It is not always necessary to command G17, G18, G19 in the same block as G73 - G89.

NOTE

Z axis can always be appointed the drilling axis by parameter setting.

Positioning can be commanded with optional axes other than the drilling axis. The drilling cycle starts after the positioning.

The following explanations are done on the XY plane, and Z axis as the drilling axis.

The following 13 types of canned cycles are available.

13 types of canned cycles (1/4)

G code	Operation		Function
	G98 mode	G99 mode	
G73			High-speed peck drilling cycle (Note 1)
G74			Counter tapping cycle
G76			Fine boring cycle

13 types of canned cycles (2/4)

G code	Operation		Function
	G98 mode	G99 mode	
G81	<p>Initial level Positon R Z point</p>	<p>R point R point level Z point</p>	Drilling cycle (Spot drilling)
G82	<p>Initial level R point P Z point</p>	<p>R point R point level P Z point</p>	Drilling cycle (Counter boring)
G83	<p>Initial level R point q d q d q q Z point</p>	<p>R point R point level q d q d q q Z point</p>	Peck drilling cycle (Note 1)
G83	<p>Initial level R point q d Over-load torque Dwell Z point</p>	<p>R point R point q d Over-load torque Dwell Z point</p>	Small hole peck drilling cycle

13 types of canned cycles (3/4)

G code	Operation		Function
	G98 mode	G99 mode	
G84	<p>Initial level Positon R Z point P Spindle CW Spindle CCW</p>	<p>Initial level Positon R Z point P Spindle CW R point level Spindle CCW</p>	Tapping cycle
G85	<p>Initial level Positon R Z point</p>	<p>Initial level Positon R Z point R point level</p>	Boring cycle
G86	<p>Initial level Positon R Z point Spindle CW Spindle stop</p>	<p>Initial level Positon R Z point Spindle CW R point level Spindle stop</p>	Boring cycle
G87	<p>Initial level Positon R Z point R point Spindle CW q l</p>	Not used	Back boring cycle

13 types of canned cycles (4/4)

G code	Operation		Function
	G98 mode	G99 mode	
G88			Boring cycle

<p>—————> Cutting feed</p> <p>- - - - -> Rapid traverse</p> <p>~~~~~> Manual feed</p> <p>P Dwell</p> <p>Z Z point (Hole bottom position)</p>	<p>OSS Oriented spindle stop (Spindle stops at constant rotation position)</p> <p>⇒ Shift</p>
---	--

Note 1 "d" of G73 and G83 is set by parameters.

When the drilling axis is Z axis, machining data in the canned cycle is commanded as follows:

Format

G○○ X_ Y_ Z_ R_ Q_ P_ K_ F_ ;

Drilling mode G○○ ; See previous table.

Drilling position data X, Y ; Command position of the hole.

Z : Specify hole end position shown in the previous table.

R : Specify R point position shown in the previous table.

Q : Specify cutting quantity with G73, G83, and shift quantity with G76, G87,

P : Specify dwell time at the hole bottom.

K : Specify how many times to repeat.

When specified K0, drilling data will be set, but no drilling will be done.

F : Specify feed rate for cutting.

Explanations

• R point level return (G99)

By specifying G99, return point in canned cycle is specified to R point. The drilling starts from the end point of the previous block. If the previous block has ended in the initial point, it begins from the initial point and returns to the R point.

Example) When G81 was commanded under G99 mode

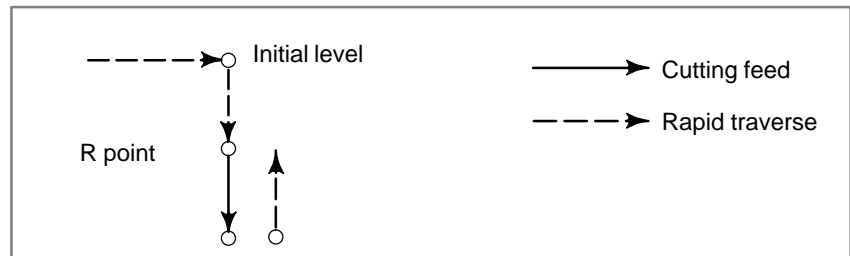

• Initial level return (G98)

By specifying G98, return point in canned cycle is specified to the initial level. The drilling starts from the end point of the previous block. If the previous block has ended in the R point, it begins from the R point and returns to the initial point.

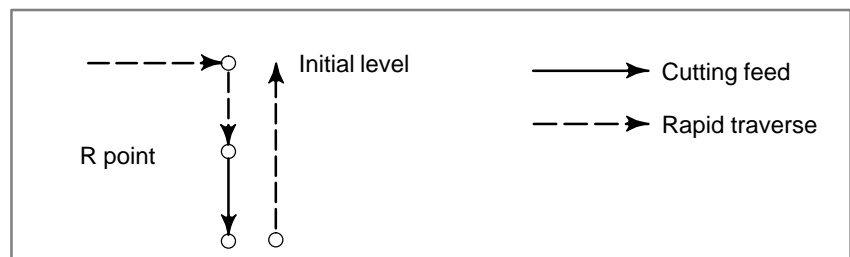

13.2 RIGID TAPPING

13.2.1 Rigid Tapping

In tapping, the feed amount of drilling axis for one rotation of spindle should be equal to the pitch of screw of tapper. Namely, the following conditions must be satisfied in the best tapping:

$P = F/S$,

where P : Pitch of screw of tapper (mm)

F : Feed rate of drilling axis (mm/min)

S : Spindle speed (rpm)

The rotation of spindle and feed of Z axis are independently controlled in the tapping cycle G74/G84 (M series), G84/G88 (T series). Therefore, the above conditions may not always be satisfied. Especially at the hole bottom, both the rotation of spindle and feed of drilling axis reduce the speed and stop. After that, they move in the inverse direction while increasing the speed. However, the above conditions may not be satisfied in general since each acceleration/deceleration is performed independently. Therefore, in general, the feed is compensated by mounting a spring to the inside of holder of tapper to improve the accuracy of tap cutting.

The rotation of spindle and feed of drilling axis are controlled so that they are always synchronous each other in the rigid tapping cycle. Namely, in other than rigid tapping, control for speed only is performed. In the rigid tapping however, position control is also performed during the rotation of spindle, that is, the rotation of spindle and feed of drilling axis are controlled as linear interpolation of two axes.

This allows the following condition to be satisfied also during acceleration/deceleration at the hole bottom and a tapping of improved accuracy to be made.

$P = F/S$

The pitch of screw tap can be directly specified.

Rigid tapping can be performed by executing any of the following commands:

- M29 S○○○○○ before tapping command G74/G84 (M series) or G84/G88 (T series)
- M29 S○○○○○ in the same block as tapping command G74/G84 (M series) or G84/G88 (T series)
- G74/G84 (M series) or G84/G88 (T series) as rigid tapping G code (Whether G74/G84 (G84/G88) is used as rigid tapping G code or ordinary tapping G code can be selected with a parameter.)

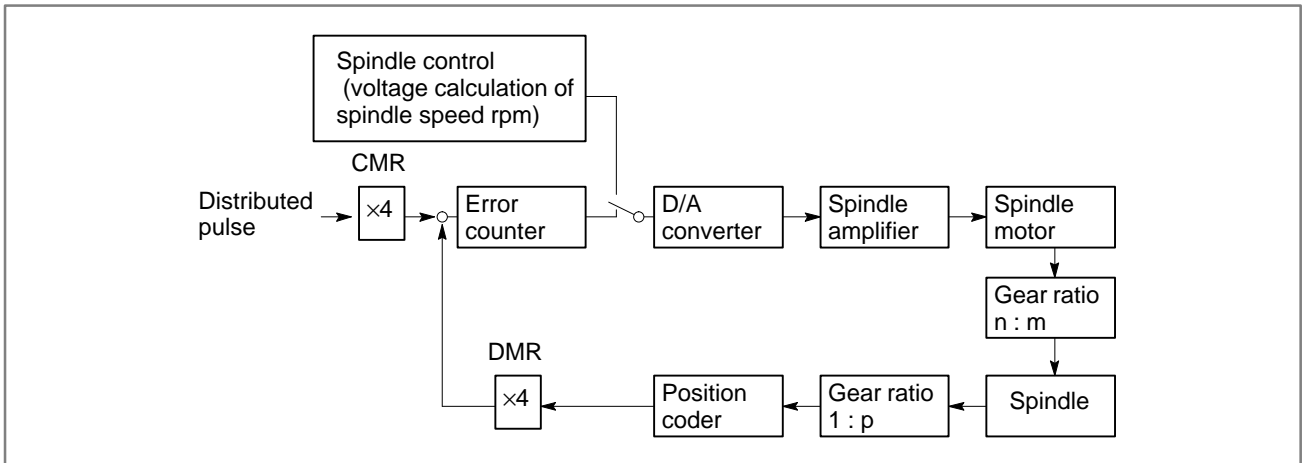

The Control System of Spindle during Rigid Tapping

Gear ratio of spindle to position coder (1 : p)	Least command increment (detection unit) deg
1 : 1	0.088 (1x360 / 4096)
1 : 2	0.176 (2x360 / 4096)
1 : 4	0.352 (4x360 / 4096)
1 : 8	0.703 (8x360 / 4096)

Even use of the spindle motor incorporating the position coder enables rigid tapping. In this case, the gear ratio of the spindle motor and the spindle is set by the parameter.

In addition, use of the spindle motor incorporating the position coder enables rigid tapping but disables threading and per revolution dwell.

Pull-out override

• **Parameter setting-based method**

Override with a previously set parameter value can be applied to the pull-out operation.

Theoretically, it is possible to apply a pull-out override of up to 2000% (20 times). (Also take machine-imposed restrictions into account.)

If an override result would exceed the maximum permissible spindle rotation speed (specified in a parameter) for rigid tapping, the actual spindle speed is clamped at the maximum permissible spindle rotation speed.

- **Program instruction-based method**

A program instruction can specify to apply override to a pull-out operation. (Using this method requires setting an additional parameter.) To specify pull-out override with a program instruction, specify a pull-out spindle rotation speed as one of the hole making data items in a G84 block, using the J address.

This instruction applies override with a value obtained in the following expression to a pull-out operation.

$$\frac{\text{Spindle rotation speed (instruction with the J address) for a return}}{\text{Spindle rotation speed (instruction with the S address)}} \times 100 = \text{Pull-out override value}$$

If the result of conversion made with the above expression does not fall in a pull-out override range of from 100% to 2000%, the spindle rotation instruction is disabled for the pull-out operation; the actual spindle rotation becomes 100%.

If the J instruction value is greater than the maximum permissible spindle rotation speed (specified in a parameter) for rigid tapping, the actual spindle rotation speed is clamped at or near the maximum permissible spindle rotation speed.

Example)

To make a pull-out operation twice faster than a cut-in operation, use the following instructions:

```
.
M29 S1000;
G84 Z-1000. F1000 J2000 ;
.
```

Feedrate override

Appropriate parameter setting enables the conventional feedrate override select signal and override cancel signal even when rigid tapping is under way.

In this case, the override value selected by the override select signal can be used for rigid tapping.

- <G012#0-7> is used as the override select signal.
- <G006#4> is used as the override cancel signal.
- The override value can be changed even when rigid tapping is under way.
- Using an applicable option enables the second feedrate override function. This function is applied to the second feedrate that is determined according to the first feedrate override function.
- The spindle override value is fixed at 100% when rigid tapping is under way. Because the spindle operation is synchronized with the operation of the tapping axis, the spindle speed is affected indirectly by the feedrate override value.
- Enabling the feedrate override select signal disables pull-out override (regardless of whether it is specified by a program instruction or owing to a rigid tapping return), causing feedrate override to be applied to the pull-out operation.

- Even if the feedrate override select signal is enabled, setting the override cancel signal to 1 causes 100% override to be applied to a cut-in operation. If pull-out override is enabled, it is applied to the pull-out operation.

The following table lists rigid tapping versus override value correspondence.

Rigid tapping versus feedrate override value correspondence

		Cut-in operation	Pull-out operation
Feedrate override = Disabled Pull-out override = Disabled		100%	100%
Feedrate override = Disabled Pull-out override = Enabled		100%	Pull-out override (*)
Feedrate override = Enabled Pull-out override = Disabled	Override cancel signal <G006#4> = 0	Feedrate override signal value	Feedrate override signal value
	Override cancel signal <G006#4> = 1	100%	100%
Feedrate override = Enabled Pull-out override = Enabled	Override cancel signal <G006#4> = 0	Feedrate override signal value	Feedrate override signal value
	Override cancel signal <G006#4> = 1	100%	Pull-out override (*)

- * The pull-out override can be any of the following:
- <1> Parameter-set pull-out override
 - <2> Program-specified pull-out override
 - <3> Rigid tapping return-based pull-out override

13.2.2 Rigid Tapping Bell-shaped Acceleration/ Deceleration

M series

Bell-shaped acceleration/deceleration can be used for rigid tapping. Generally, using bell-shaped acceleration/deceleration can reduce the required acceleration/deceleration time because the time constant of rigid tapping can be decreased.

For bell-shaped acceleration/deceleration for rigid tapping, the linear acceleration/deceleration constant and the time corresponding to the bell-shaped curve are specified using parameters.

The bell-shaped acceleration/deceleration time for rigid tapping is the sum of the time constant of linear acceleration/deceleration for the spindle and rigid tapping axis (conventional parameter setting T1) and the time corresponding to the curved portion (parameter setting T2).

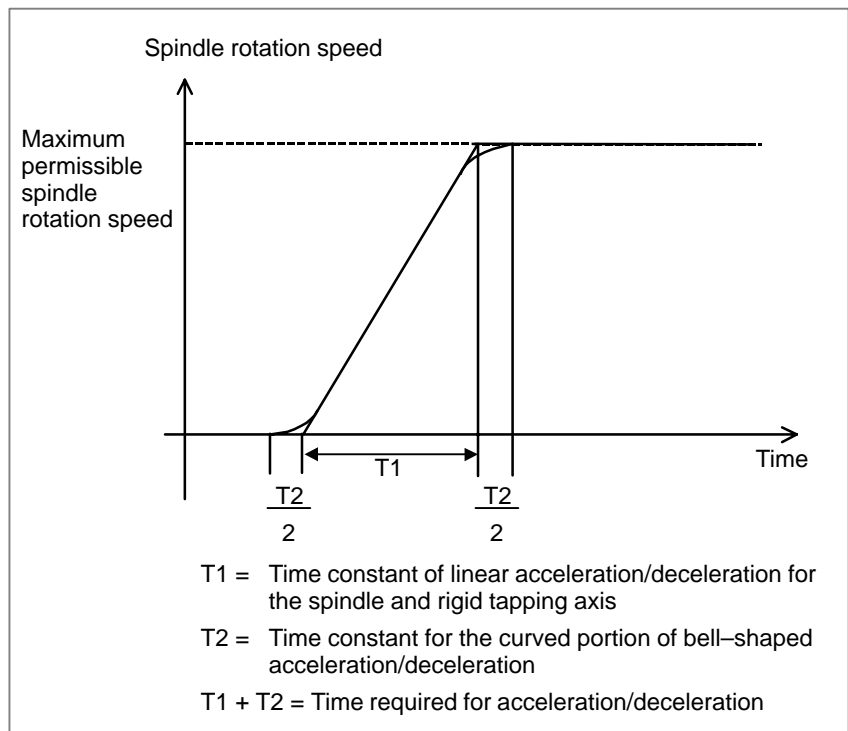

The actual time constant of linear acceleration/deceleration for the spindle and tapping axis, T_1 , is determined according to a ratio of the maximum permissible spindle rotation speed to the actually specified S. However, the time constant for the curved portion of bell-shaped acceleration/deceleration is not proportional to the actual S instruction, so a constant acceleration/deceleration (specified using a parameter) is always maintained.

13.2.3 Three-dimensional Rigid Tapping

Issuing a rigid tapping instruction in the three-dimensional coordinate conversion mode can cause a rigid tapping operation to be performed at an angle specified in a three-dimensional coordinate conversion instruction.

Three-dimensional rigid tapping is used always together with three-dimensional coordinate conversion.

13.2.4 **M series** Other Rigid Tapping Functions

The following functions related to rigid tapping are also available:

- Rigid tapping by manual handle feed (See Section II-23.10.)
- Rigid tapping return (See Section II-24.11.)

13.3 EXTERNAL OPERATION FUNCTION (G81)

M series

With the above program, external operation signal is output after positioning. G80 command cancels the external operation function.

Format

G81 IP_ ;

IP : Optional combination of axis address X, Y, Z, U, V, W, A, B, C

13.4 **T series**
CANNED CYCLES
FOR TURNING

The following three kinds of canned cycle are provided.

13.4.1
Cutting Cycle A (G77)
(with G Code System A:
G90)

- **Straight cutting cycle.**

The command below actuates a straight cutting cycle.

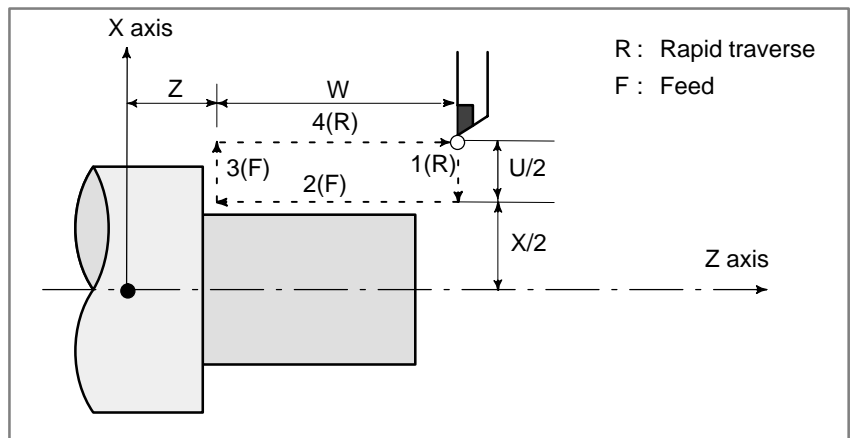

Format

```
G77 X_ Z_ F_ ;
```

- **Tapered cutting cycle**

The command below actuates a tapered cutting cycle. In the figure below, when the direction of route 1 is -X, R is a negative value. Inverting the sign of R enables reverse taper cutting.

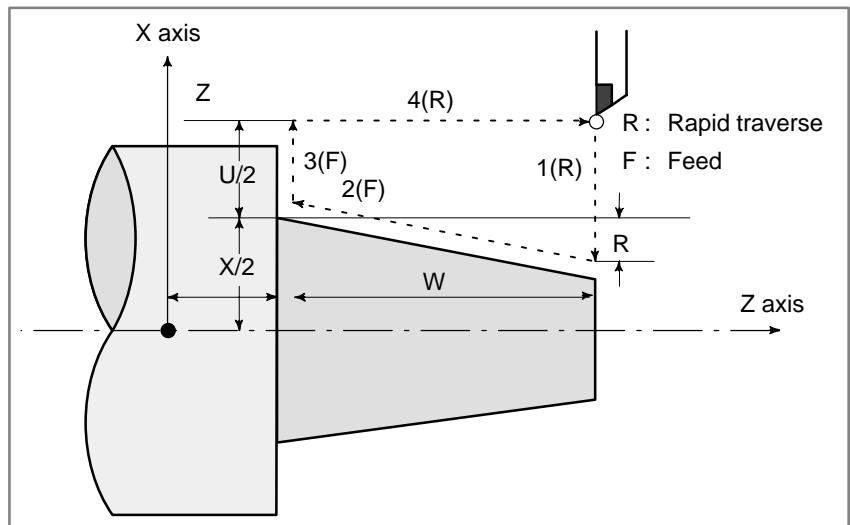

Format

```
G77 X_ Z_ R_ F_ ;
```

**13.4.2
Thread Cutting Cycle
(G78) (with G Code
System A: G92)**

- **Straight thread cutting cycle**

The command below actuates a straight thread cutting cycle.

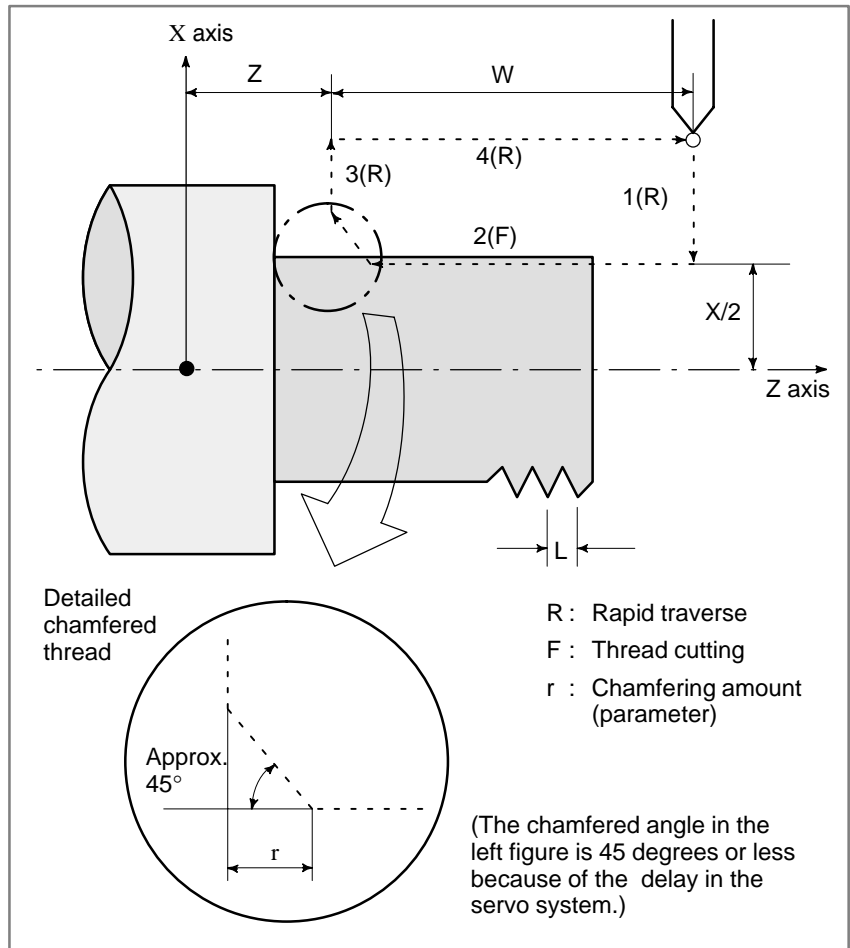

Format

```
G78 X_ Z_ F_ ;
```

● **Tapered thread cutting cycle**

The command below actuates a tapered thread cutting cycle.

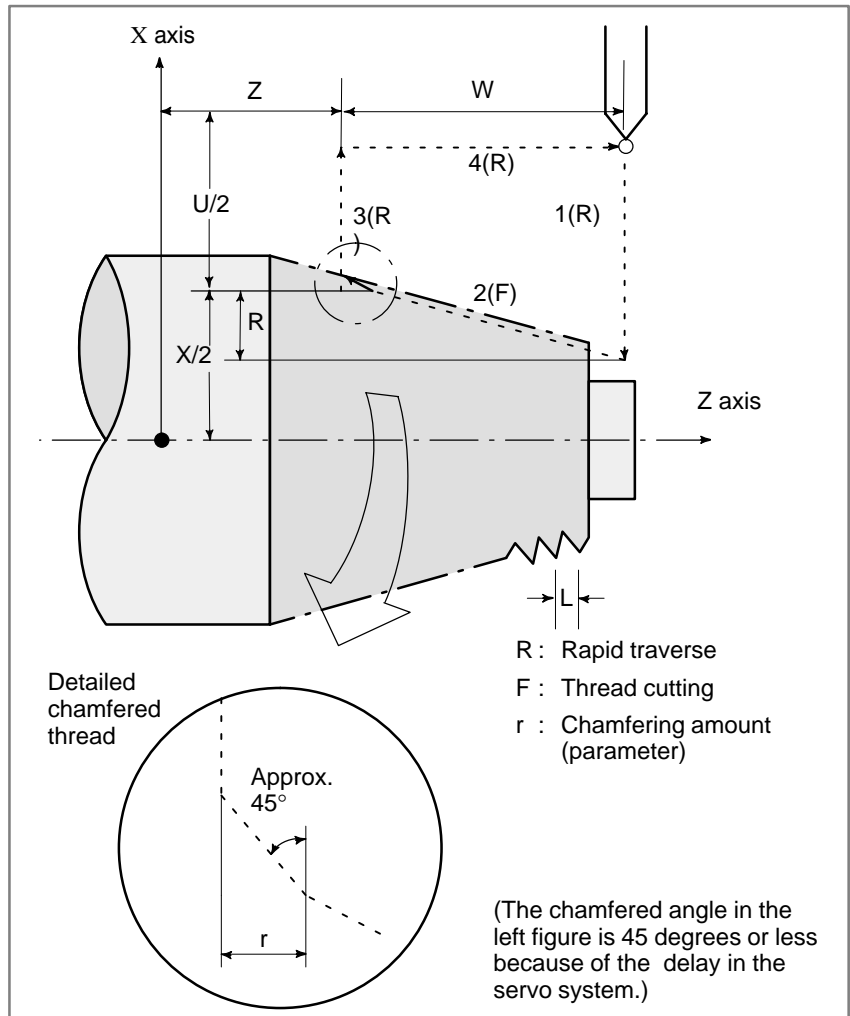

Format

```
G78 X_ Z_ R_ F_ ;
```

NOTE
 Screw chamfering can be inhibited by entering the chamfering signal.

13.4.3
Turning Cycle in Facing (G79)
 (with G Code System A: G94)

- **Face cutting cycle**

The command below actuates a face cutting cycle.

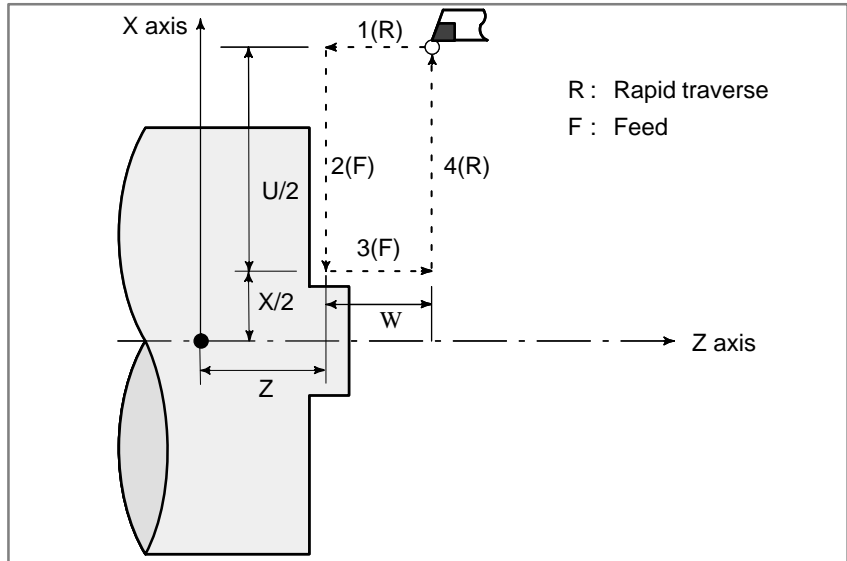

Format

```
G79 X_ Z_ F_ ;
```

- **Face tapered cutting cycle**

The command below actuates a face tapered cutting cycle. In the following figure, if the direction of the path 1 is negative in Z axis, the sign of the number following address R is negative.

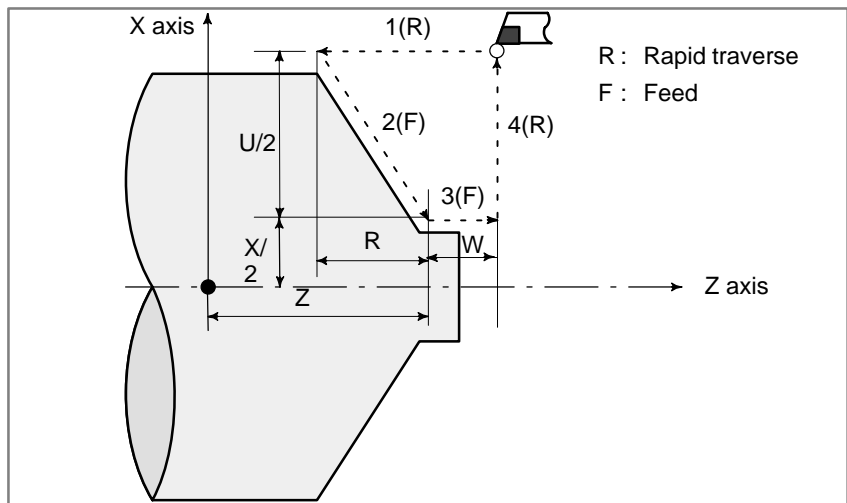

Format

```
G79 X_ Z_ R_ F_ ;
```

13.5 **T series**
MULTIPLE REPETITIVE CYCLES FOR TURNING (G70 - G76)

A multiple repetitive cycle is composed of several canned cycles. A tool path for rough machining, for example, is determined automatically by giving the data of the finishing work shape. A thread cutting cycle has also been prepared.

13.5.1
Stock Removal in Turning (G71)

There are two types of rough cutting cycles for external surfaces, type I and type II.

• **Type I**

If a finishing shape of A to A' to B is given in the figure below, machining is done with the cutting depth Δd and the finishing allowance $\Delta U/2$ and ΔW .

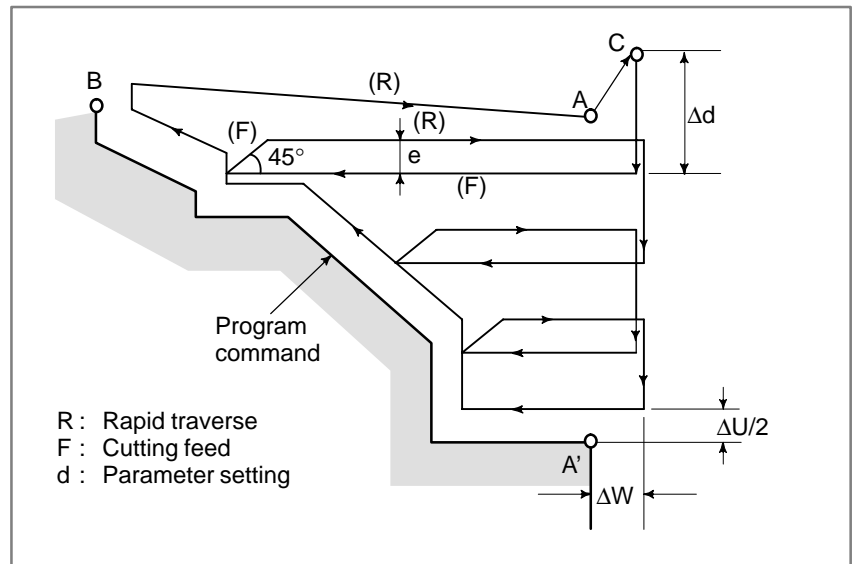

Format

G71 U(Δd) R(e) ;
G71 P(ns) Q(nf) U(Δu) W(Δw) F(f) S(s) T(t) ;

N(ns)

 F_
 S_
 T_
 N(nf) ;

} A block between sequence numbers ns and nf specifies the target figure between A and B.

Δd : Depth of cut. It is specified without sign. The cutting direction is determined by the direction of AA'.

e : Clearance

ns : Sequence number of the first block of target figure blocks

nf : Sequence number of the end block of the target figure blocks

Δu : Distance and direction of finishing allowance along X axis

Δw : Distance and direction of finishing allowance along Z axis

f, s, t : The F, S, and T specified by a block between ns and nf are ignored during cycle operation. Those specified by the block of G71 or before are effective.

F, S, and T in the blocks of move commands from A to B are ignored and those specified in the same block as G71 or before are effective.

G96s (constant surface speed control on) and G97s (constant surface speed control off) in the blocks of move commands from A to B are ignored. A G96 or a G97 commanded in the same block as G71 or before is effective. The following four patterns are given depending on the sign of delta U and delta W as in the figure below. All of these cutting cycles are made parallel to Z axis.

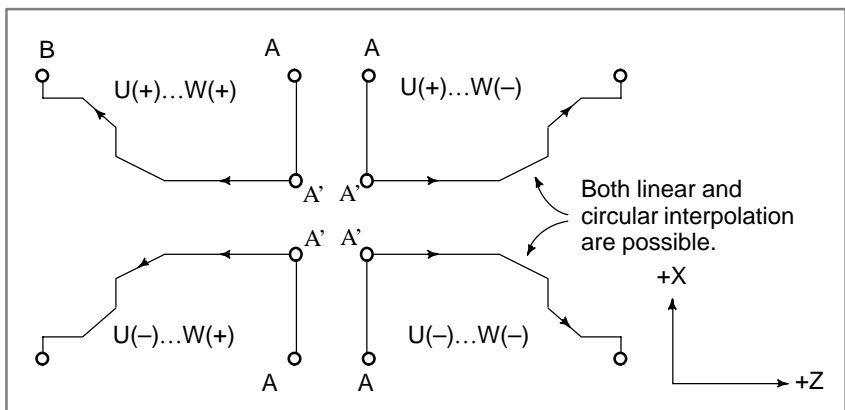

For the path from A to A', the block of sequence number ns specifies a command including G00 or G01. For the path A' to B, increase or decrease must be steady in both X-axis and Z-axis directions.

If the command for the path from A to A' is G00, the cutting along the path is performed in the G00 mode. If the command for the path from A to A' is G01, the cutting is performed in the G01 mode.

• **Type II**

Type II differs from Type I in the following point.

Increase in X-axis direction does not need to be steady. Up to 10 pockets are allowed.

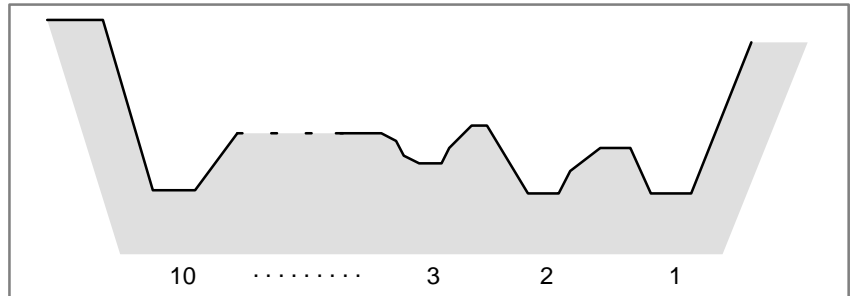

In Z-axis direction, however, increase or decrease must be steady. The following figure is not allowed for machining.

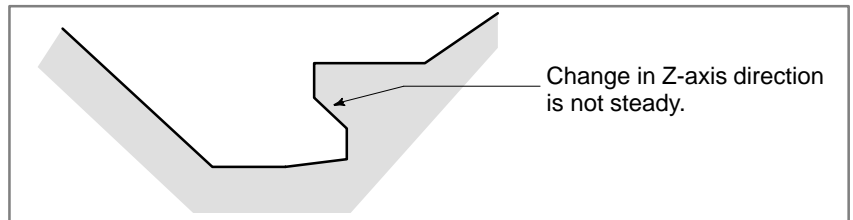

The first cutting does not need to be vertical. Any profile is allowed as far as the change in Z-axis direction is steady.

For clearance after turning, chamfering is performed along the workpiece profile.

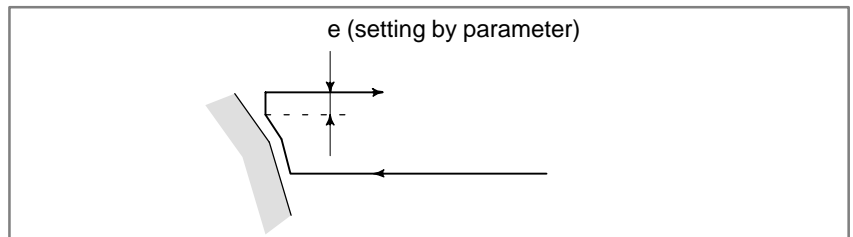

The following figure shows an example of a cutting path when there are two pockets.

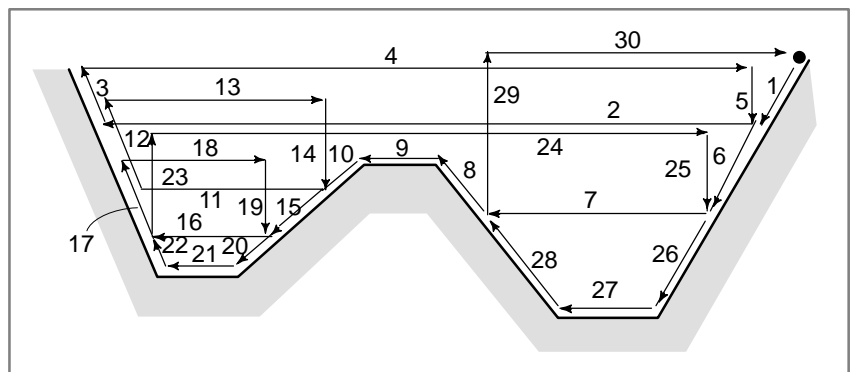

The offset of tool tip R is not added to the finishing allowance Δu and Δw . It is assumed to be zero for cutting. Generally $\Delta w=0$ is specified. Otherwise, the tool catches into a side wall. The two axes X(U) and Z(W) are specified in the first block of the repeat part. If there is no movement in Z-axis direction, W0 is specified.

This function is effective only in memory mode.

- Use of Types I and II

Type I:

Used when only one axis is specified in the first block (ns block) in the repeat part.

Type II

Used when two axes are specified in the first block in the repeat part.

Example)

Type I

```
G71 10.0 R5.0 ;  
G71 P100 Q200 ... ;  
N100 X(U)_ ;  
  ;  
B200... ;
```

Type II

```
G71 10.0 R5.0 ;  
G71 P100 Q200 ... ;  
N100 X(U)_ Z(W)_ ;  
  ;  
B200... ;
```

13.5.2 Stock Removal in Facing (G72)

As shown in the figure below, this cycle is the same as G71 except that cutting is made parallel to X-axis.

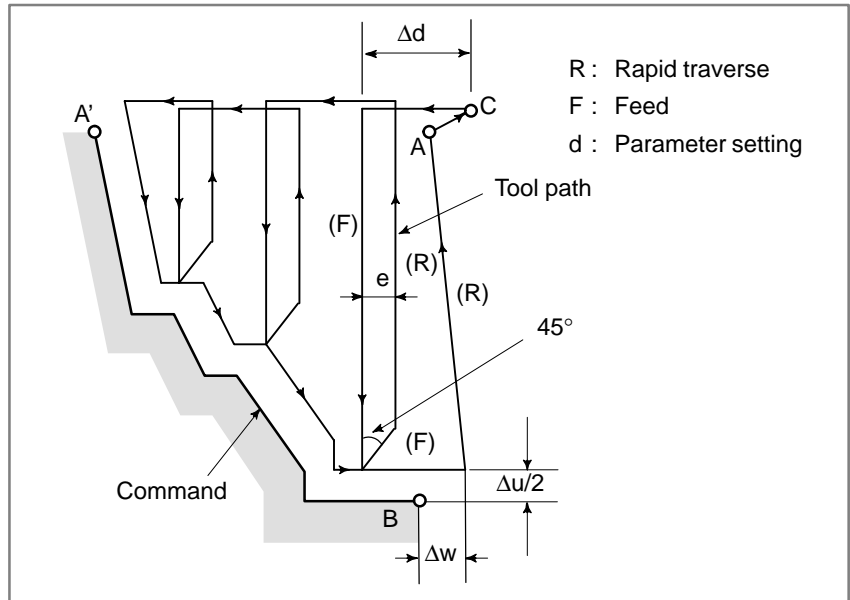

Format

```

G72 W( $\Delta d$ ) R( $e$ ) ;
G72 P( $ns$ ) Q( $nf$ ) U( $\Delta u$ ) W( $\Delta w$ ) F( $f$ ) S( $s$ ) T( $t$ ) ;
    
```

Δd , e , ns , nf , Δu , Δw , f , s , and t are the same as those in G71.

For the shape to be cut by G72, the following four patterns are considered. Any of them is cut by repetition of operation parallel to the X axis of the tool. The signs of ΔU and ΔW are as follows:

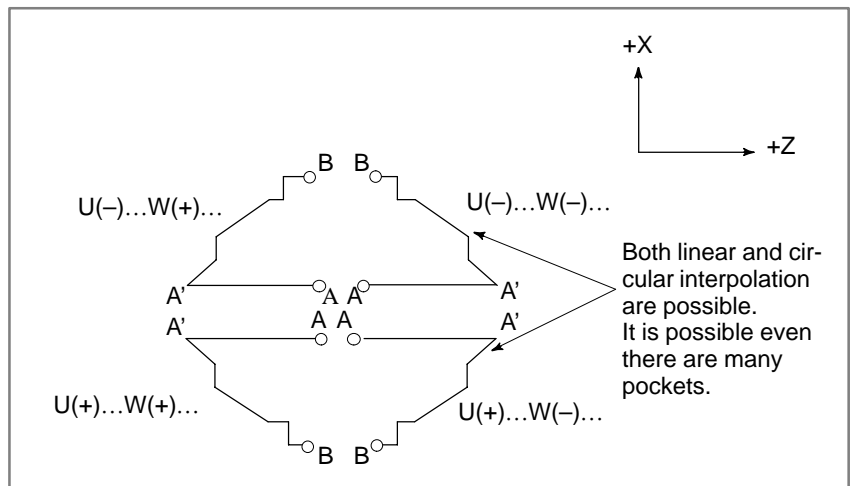

This function is effective only in memory mode.

13.5.3 Pattern Repeating (G73)

This function permits cutting a fixed cutting pattern repeatedly with the position being displaced bit by bit. By this cutting cycle, it is possible to efficiently cut the work whose rough shape has already been made by rough machining, forging, or casting, etc.

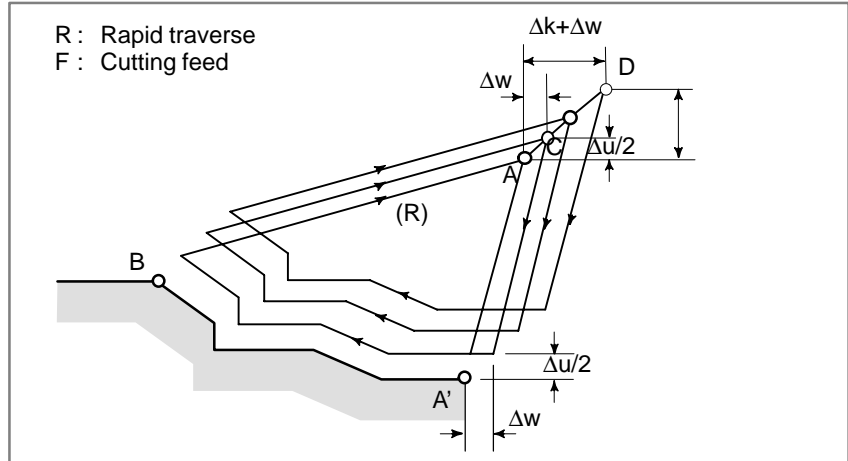

Pattern to be specified by the program
Point A → Point A' → Point B

Format

G73 U(Δi) W(Δk) R(d) ;

G73 P(ns) Q(nf) U(Δu) W(Δw) F(f) S(s) T(t) ;

N(ns)

.

. F₋

. S₋

. T₋

N(nf) ;

} The move commands for the target figure from A to A' then to B are specified by blocks between sequence numbers ns and nf.

Δi : Distance and direction of the clearance along X axis (radius programming)

Δk : Distance and direction of the clearance along Z axis

d : Number of divisions which is equal to the number of times that rough cutting is performed

ns : Sequence number of the first block of target figure blocks

nf : Sequence number of the end block of target figure blocks

Δu : Distance and direction of the finishing allowance along X axis (diameter or radius programming)

Δw : Distance and direction of the finishing allowance along Z axis

f, s, t : F, S, and T codes

CAUTION

F, S, and T specified by any block between ns and nf are ignored. Those specified by the block of G73 or before are effective.

This function is available for only memory mode.

13.5.4 Finishing Cycle (G70)

After rough machining with G71, G72 or G73 the following command actuates finishing.

Format

G70 P(ns) Q(nf) ;

P : Sequence number of cycle start (ns)

Q : Sequence number of cycle end (nf)

NOTE

F, S, and T codes specified in the block of G71, G72 or G73 are ignored. But F, S, and T codes specified in the blocks from sequence numbers (ns) to (nf) become effective

The function is effective only in memory mode.

**13.5.6
Grooving in X-axis
(G75)**

The following tape command permits operation as seen in the figure below. This is equivalent to G74 except that X is replaced by Z. Chip breaking is possible in this cycle. Grooving in the X-axis (in this case, Z, W and Q are omitted) is possible.

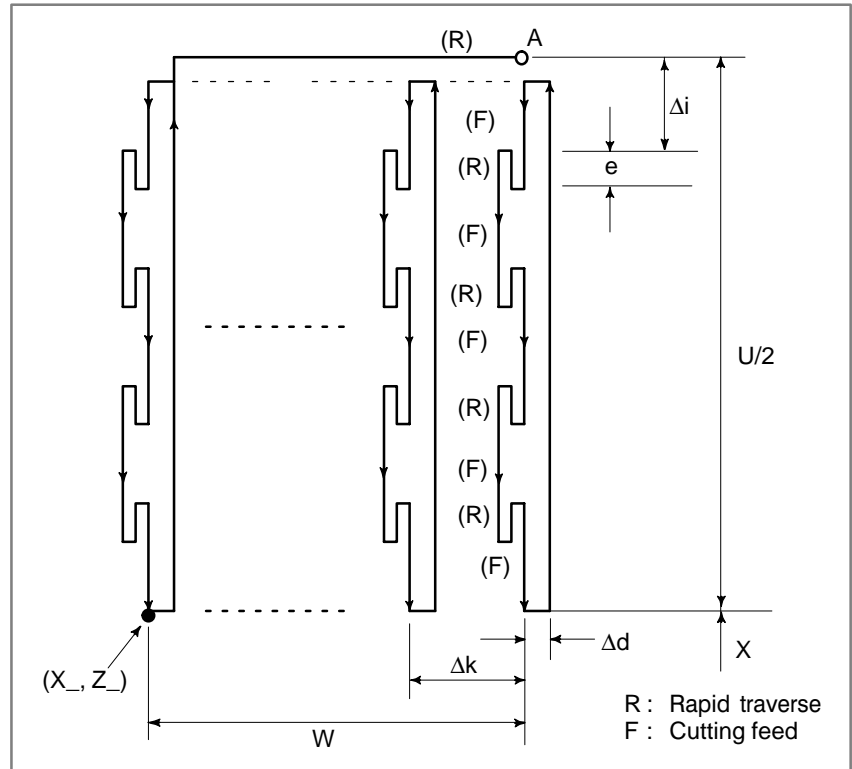

Format

```
G75 R(e) ;
G75 { X- Z- } P(Δi) Q(Δk) R(Δd) F(f) ;
      { U- W- }
```

13.5.7 Thread Cutting Cycle (G76)

A thread cutting cycle as shown below can be made.

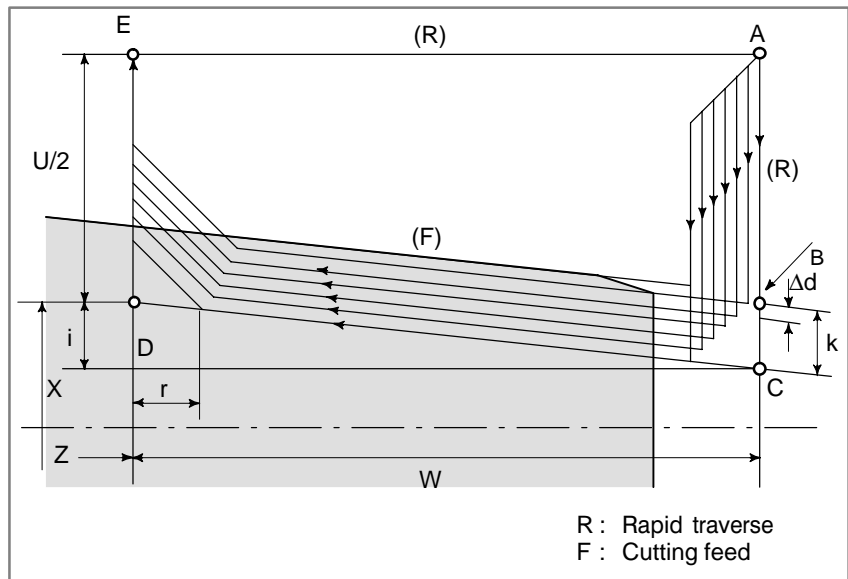

Format

G76 P(m)(r)(a) Q(Δd min) R(d) ;

G76 { $\begin{matrix} X & Z \\ U & W \end{matrix} \} R(i) P(k) Q(\Delta d) F(\ell) ;$

m : Number of final finishing repeats 1 to 99

r : Screw finishing (chamfering amount)

a : Tool tip angle (thread angle)

One of the six angles, 80°, 60°, 55°, 30°, 29°, and 0°, can be selected as a 2-digit number. m, r, and a are specified in address P at the same time.

Example)

When m = 2, r = 1.2ℓ, and a = 60°, they are specified as follows:

$\frac{P02}{m} \frac{12}{r} \frac{60}{a}$

Δbmin: Minimum depth of cut

d : Finishing allowance

i : Difference in thread radius
Straight threading for i = 0

k : Height of the thread (The distance in X-axis direction is specified with a radius value.)

Δd : Depth of first cut (specified with a radius value)

ℓ : Screw lead (same as threading of G32)

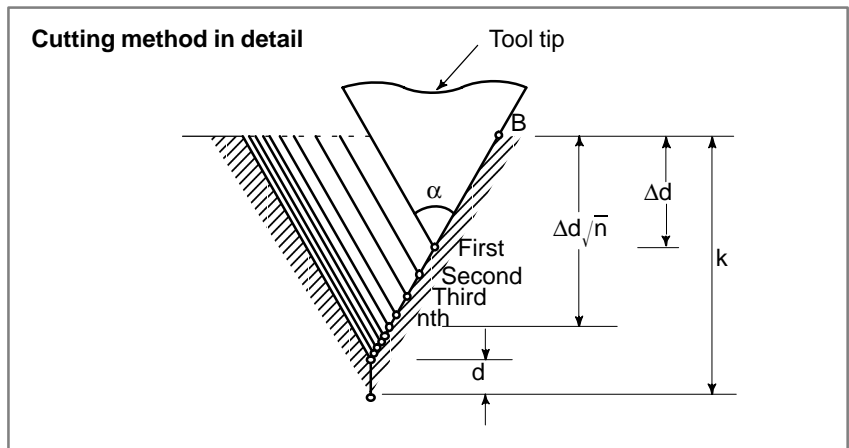
**NOTE**

Thread chamfering can be inhibited by entering the chamfering signal.

13.6 **T series**
**CANNED CYCLES
FOR DRILLING
(G80 - G89)**

The canned cycles for drilling enable one block including the G function to specify the machining which is usually specified by several blocks. Programming is then simplified.

The canned cycles for drilling conform to JIS B 6314.

Canned cycles

G code	Drilling axis	Drilling	Operation at hole bottom	Clearance	Use
G80					Cancel
G83	Z axis	Cutting feed Intermittent feed	Dwell	Rapid traverse	Deep drilling
G84	Z axis	Cutting feed	Spindle reverse	Cutting feed	Tapping
G85	Z axis	Cutting feed	Dwell	Cutting feed	Boring
G87	X axis	Cutting feed Intermittent feed	Dwell	Rapid traverse	Deep drilling
G88	X axis	Cutting feed	Spindle reverse	Cutting feed	Tapping
G89	X axis	Cutting feed	Dwell	Cutting feed	Boring

13.7 T series CHAMFERING AND CORNER R

A chamfer or corner are can be inserted between two blocks which intersect at a right angle as follows. An amount of chamfering or corner are specifies by address I, K, or R.

- Chamfering
Z → X

Command	Tool movement
<p>G01 Z(W) I(C) ±i ;</p> <p>Specifies movement to point b with an absolute or incremental command in the figure on the right.</p>	

- Chamfering
X → Z

Command	Tool movement
<p>G01 X(U) K(C) ±k ;</p> <p>Specifies movement to point b with an absolute or incremental command in the figure on the right.</p>	

- Corner R
Z → X

Command	Tool movement
<p>G01 Z(W) R ±r ;</p> <p>Specifies movement to point b with an absolute or incremental command in the figure on the right.</p>	

● **Corner R**
X → Z

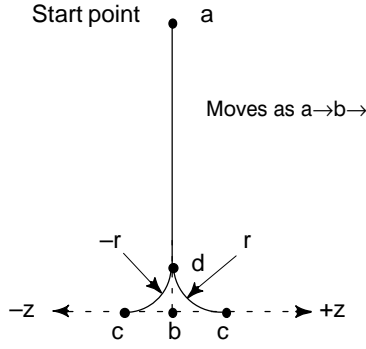
Command	Tool movement
<p>G01 X(U) R ±r ;</p> <p>Specifies movement to point b with an absolute or incremental command in the figure on the right.</p>	 <p>Start point a</p> <p>Moves as a→b→c</p>

CAUTION

If C is not used as an axis name, C can be used for a chamfer address instead of I or K.

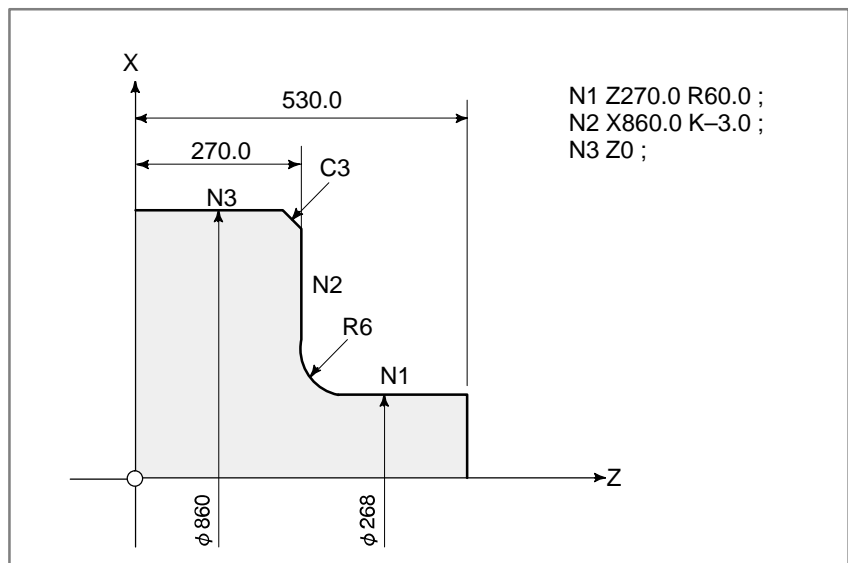

13.8 M series OPTIONAL ANGLE CHAMFERING/ CORNER ROUNDING

The block for chamfering or corner rounding can be inserted automatically between two optional linear interpolations, or between the linear interpolation and circular interpolation, or between two circular interpolations.

Specifying **”,C_”** inserts the block for chamfering, and specifying **”,R_”** inserts the block for corner rounding. They must be specified at the end of the block which specifies the linear interpolation (B01) or circular interpolation (G02 or G03).

The numeric following C specifies the distance between the virtual corner intersection and the chamfering start or end point. See the figure below.

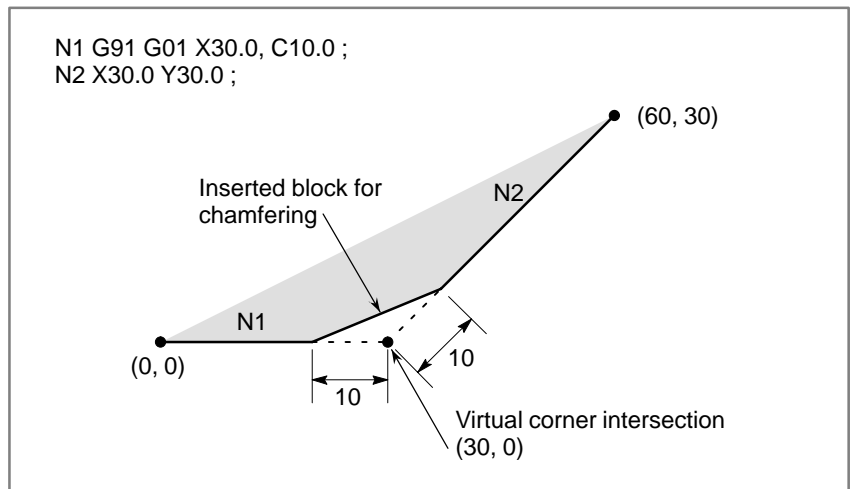

The numeric following R specifies the radius value of corner rounding. See the figure below.

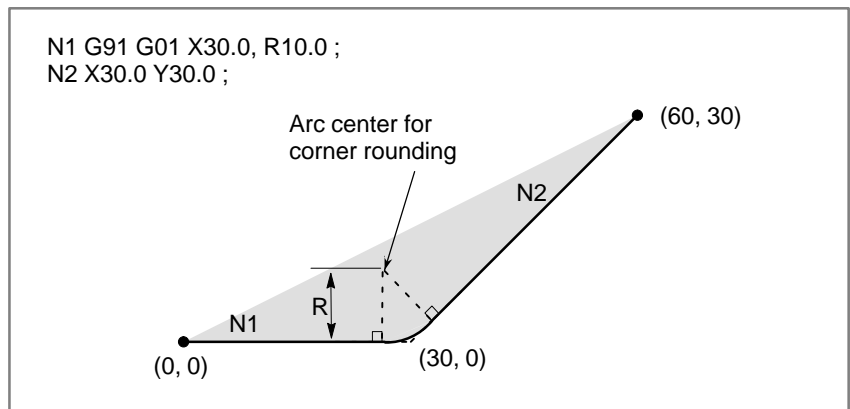

13.9 T series DIRECT DRAWING DIMENSIONS PROGRAMMING

Angles of straight lines, chamfering values, corner rounding values, and other dimensional values on machining drawings can be programmed by directly inputting these values. In addition, the chamfering and corner rounding can be inserted between straight lines having an arbitrary angle. The straight line angle, chamfering value, or corner rounding must be specified with a comma as follows:

,A_
,C_
,R_

NOTE

When A or C is not used as an axis name, the line angle, chamfering value, or corner rounding can be specified in the parameter without comma as follows:

A_
C_
R_

Command list

	Command	Movement of tool
1	X ₂ _ Z ₂ _, A_ ₋ ;	
2	,A ₁ _ ; X ₃ _ Z ₃ _, A ₂ _ ;	
3	X ₂ _ Z ₂ _, R ₁ _ ; X ₃ _ Z ₃ _ ; or ,A ₁ _, R ₁ _ ; X ₃ _ Z ₃ _, A ₂ _ ;	

	Command	Movement of tool
4	$X_2-Z_2, C_{1-};$ $X_3-Z_3;$ or $, A_{1-}, C_{1-};$ $X_3-Z_3, A_{2-};$	
5	$X_2-Z_2, R_{1-};$ $X_3-Z_3, R_{2-};$ $X_4-Z_4;$ or $, A_{1-}, R_{1-};$ $X_3-Z_3, A_{2-}, R_{2-};$ $X_4-Z_4;$	
6	$X_2-Z_2, C_{1-};$ $X_3-Z_3, C_{2-};$ $X_4-Z_4;$ or $, A_{1-}, C_{1-};$ $X_3-Z_3, A_{2-}, C_{2-};$ $X_4-Z_4;$	
7	$X_2-Z_2, R_{1-};$ $X_3-Z_3, C_{2-};$ $X_4-Z_4;$ or $, A_{1-}, R_{1-};$ $X_3-Z_3, A_{2-}, C_{2-};$ $X_4-Z_4;$	
8	$X_2-Z_2, C_{1-};$ $X_3-Z_3, R_{2-};$ $X_4-Z_4;$ or $, A_{1-}, C_{1-};$ $X_3-Z_3, A_{2-}, R_{2-};$ $X_4-Z_4;$	

13.10 **M series**
PROGRAMMABLE
MIRROR IMAGE
(G50.1, G51.1)

Mirror image can be commanded on each axis by programming. Ordinary mirror image (commanded by remote switch or setting) comes after the programmable mirror image is applied.

- **Setting of programmable mirror image**
G51.1 X_ Y_ Z_ ;
is commanded and mirror image is commanded to each axis (as if mirror was set on the axis).
- **Programmable mirror image cancel**
G50.1 X_ Y_ Z_ ;
is commanded and the programmable mirror image is canceled.

CAUTION

If mirror image is specified only for one axis on the specified plane, the operation of the commands is as follows:

- Arc command: The rotation direction is reversed.
- Cutter compensation: The offset direction is reversed.
- Coordinate rotation: The rotation angle is reversed.

When shape of the workpiece is symmetric to an axis, a program for machining the whole part can be prepared by programming a part of the workpiece using programmable mirror image and sub program.

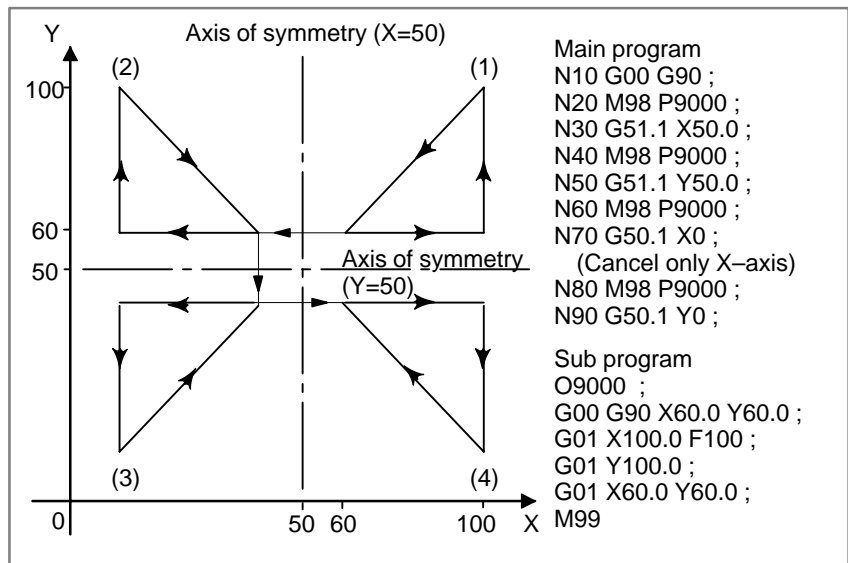

13.11 **T series** MIRROR IMAGE FOR DOUBLE TURRETS (G68, G69)

Mirror image can be applied to X axis with G code.

G68 : Double turret mirror image on

G69 : Mirror image cancel

When G68 is designated, the coordinate system is shifted to the mating turret symmetrical cutting.

To use this function, set the distance between the two turrets at parameter.

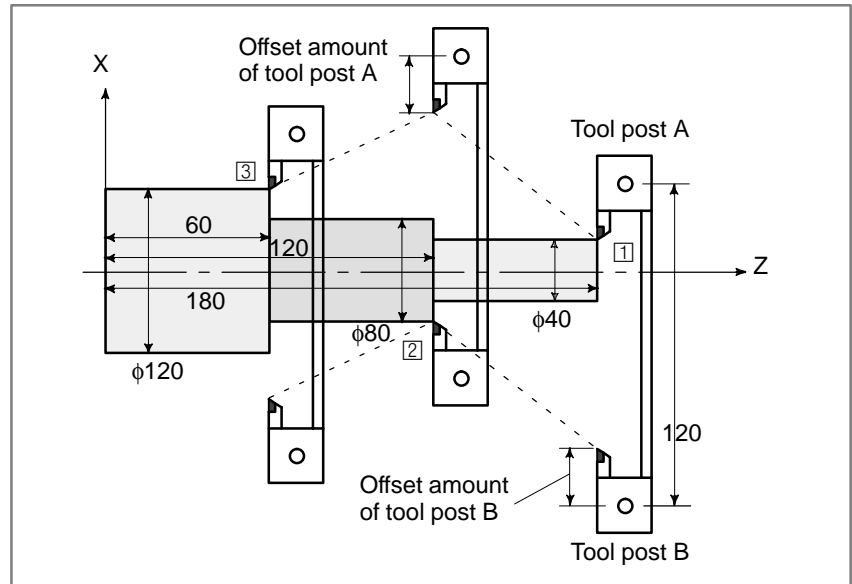

X40.0 Z180.0 T0101 ; Position turret A at [1].

G68 ; Shift the coordinate system by the distance A to B (120 mm), and turn mirror image on.

X80.0 Z120.0 T0202 ; Position turret B at [2].

G69 ; Shift the coordinate system by the distance B to A, and turn mirror image on.

X120.0 Z60.0 T101 ; Position turret A at [3].

13.12 INDEX TABLE INDEXING

M series

The index table on the machining center is indexed by using the fourth axis as an indexing axis.

To command for indexing, an indexing angle is only to be specified following a programmed axis (arbitrary 1 axis of A, B, C as the rotation axis) assigned for indexing. It is not necessary to command the exclusive M code in order to clamp or unclamp the table and therefore programming will become easy.

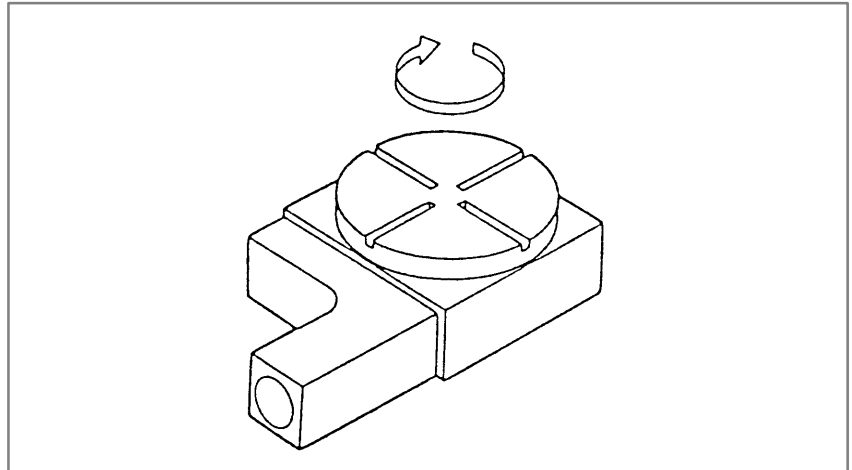

13.13 **T series**
CANNED CYCLES
FOR CYLINDRICAL
GRINDING

The repetitive machining specific to grinding can be specified by one block. Since four types of canned cycles are provided for grinding, programming is simplified.

Traverse grinding cycle
(G71, G72)

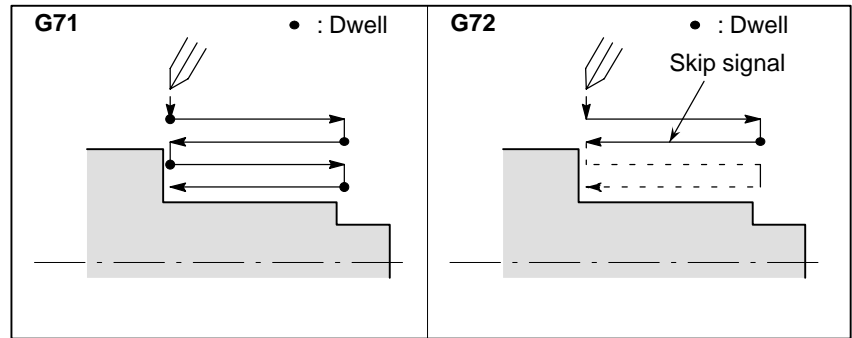

Oscillating grinding cycle
(G73, G74)

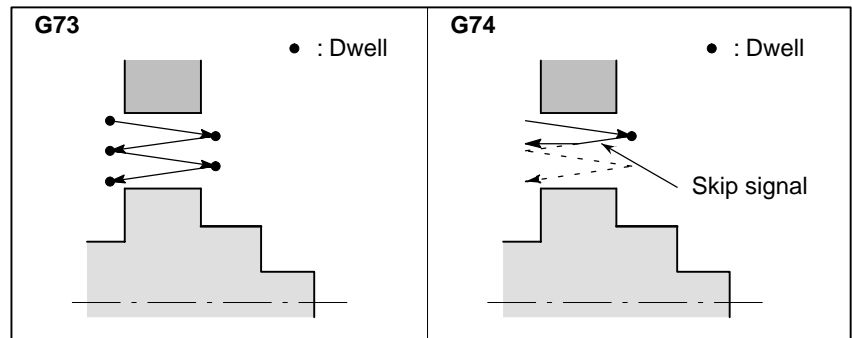

13.13.1 Traverse Grinding Cycle (G71)

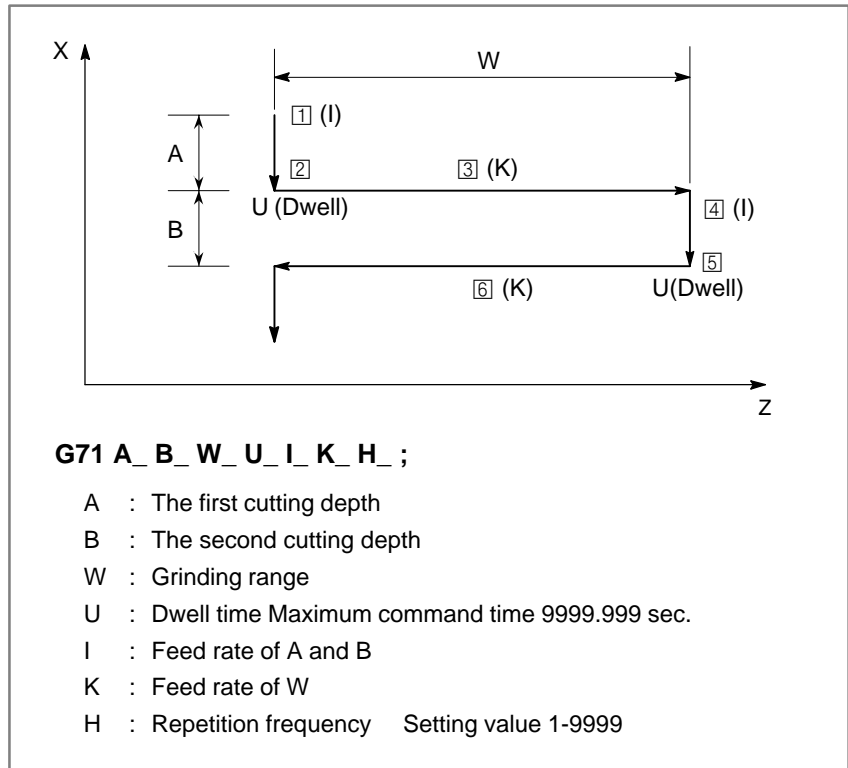

13.13.2 Traverse Direct Gauge Grinding Cycle (G72)

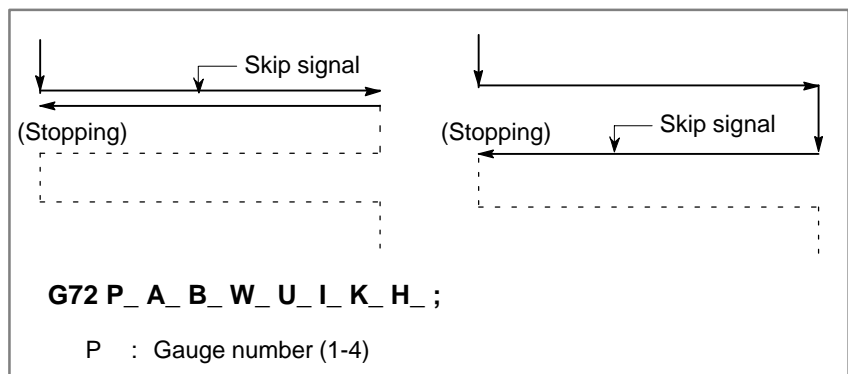

If the option of the multi-step skip is employed, gauge number can be specified. The specifying means of the gauge number is the same as the multi-step skip. If the option of the multi-step skip is not employed, a conventional skip signal becomes effective. Commands other than gauge number are similar to G71.

**13.13.3
Oscillation Grinding
Cycle (G73)**

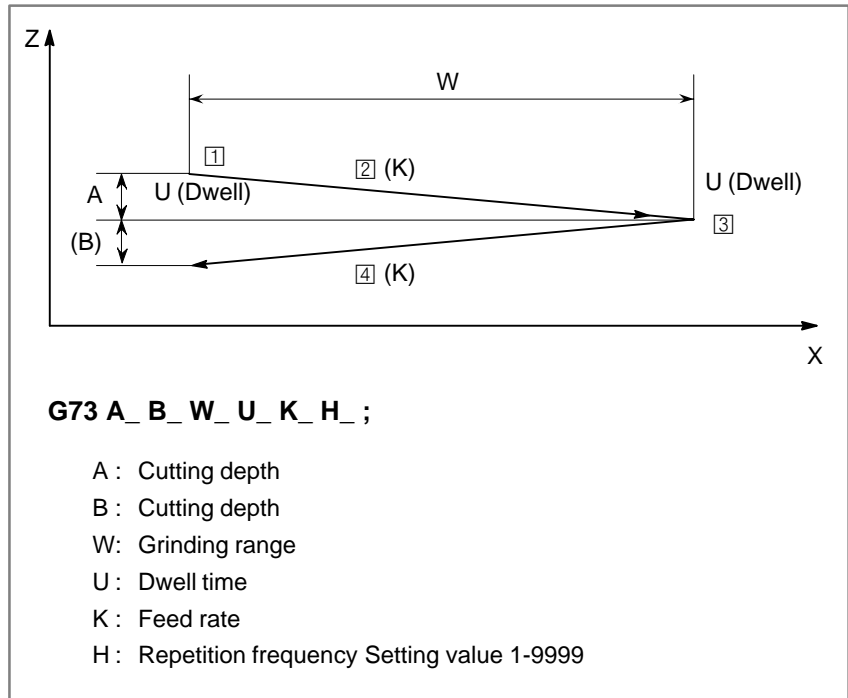

**13.13.4
Oscillation Direct
Gauge Grinding Cycle
(G74)**

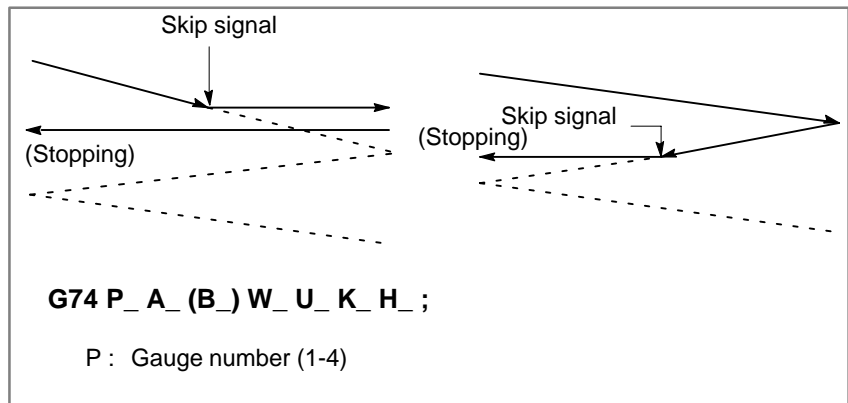

If the option of the multi-step skip is employed, gauge number can be specified. The specifying means of the gauge number is the same as the multi-step skip. If the option of the multi-step skip is not employed, a convectional skip signal becomes effective. Commands other than gauge number are similar to G73.

13.14 **M series** SURFACE GRINDING CANNED CYCLE

In the surface grinding canned cycle, repeated cutting peculiar to grinding machining normally commanded by a number of blocks, is simply programmed by commanding one block which includes the G function. There are the following 4 types of grinding canned cycle.

- **Plunge grinding cycle G75**
- **Plunge direct grinding cycle G77**
- **Continuous feed plane grinding cycle G78**
- **Intermittent feed plane grinding cycle G79**

13.14.1 Plunge Grinding Cycle (G75)

The plunge grinding cycle is possible by the following command.

Format

G75 I_ J_ K_ X(Z)_ R_ F_ P_ L_ ;

- I : The first cutting depth
(Cutting direction is by command coding.)
- J : The second cutting depth
(Cutting direction is by command coding.)
- K : Total cutting depth
- X(Z) : Grinding range (Grinding direction is by command coding.)
- R : Feed rate of I and J
- F : Feed rate of X(Z)
- P : Dwell time
- L : Grindstone wear compensation number (Note 1)

Note 1) L is specified when performing continuous dressing.

Note 2) X(Z), I, J and K commands are all incremental commands.

Explanations

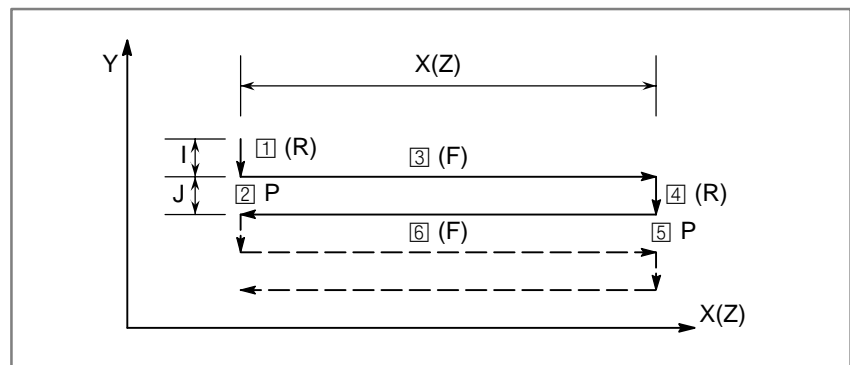

The plunge grinding cycle is made up from the following sequence of 6 operations.

The operations from ① up to ⑥ are repeated until the grindstone cutting amount reaches the total cutting amount specified by address K.

① Grindstone cutting :

Cuts in Y axis direction by cutting feed only the amount specified by the first cutting depth I. The feed rate becomes the rate specified by R.

② Dwell :

Performs dwell for only the time specified by P.

③ Grinding :

Shift by cutting feed only the amount specified by X (or Z) in the X axis direction (or Z axis direction). The feed rate becomes the rate specified by F.

4 Grindstone cutting :

Cuts in Y axis direction by cutting feed only the amount specified by the second cutting depth J. The feed rate becomes the rate specified by R.

5 Dwell :

Performs dwell for only the time specified by P.

6 Grinding (return direction) :

Sent at rate specified by F in the reverse direction only the amount specified by X (or Z).

In case of single block, the operations from 1 to 6 are performed by one cycle start. When cutting by 1 or J, in the case where the total cutting depth is reached, the cycle finishes after the following sequence of operations (up to 6) has been executed. The cutting depth in this case reaches the total cutting depth position.

- When total cutting depth is reached by the cutting operation of I or J

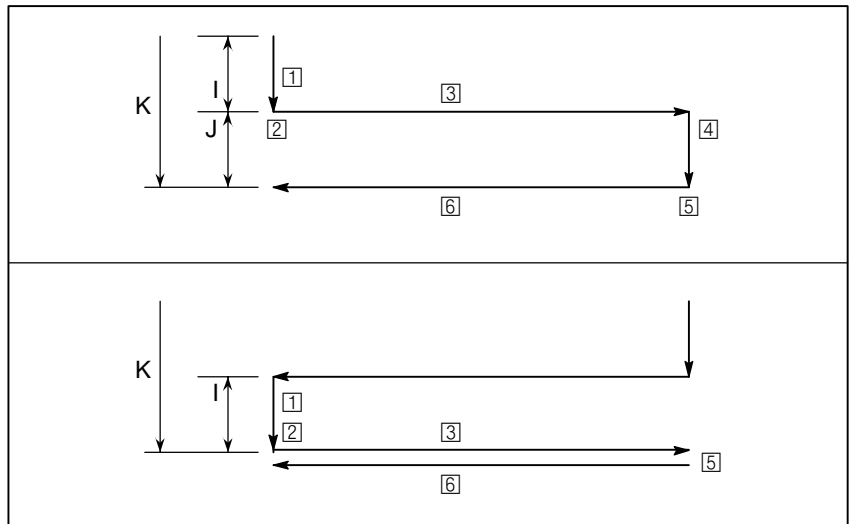

- When total cutting depth is reached in the middle of cutting of I or J

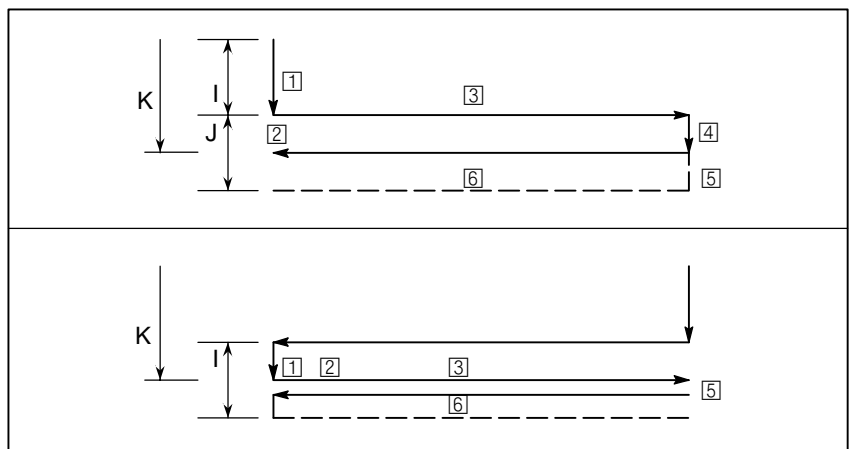

13.14.2 Plunge Direct Grinding Cycle (G77)

The plunge direct grinding cycle is possible by the following command.

Format

G77 I_ J_ K_ X(Z)_ R_ F_ P_ L_ ;

The command method is the same as the G75 case except for the G code. Further, even for the operation, the same sequence of 6 operations as the G75 case is repeated.

G77 differs from G75 as follows: Inputting a skip signal during a cycle can terminate the cycle after stopping (or terminating) the current operation sequence.

The following shows the operation at skip signal input for each operation sequence.

Explanations

- **Case of during operation sequence ① and ④ (when I and J shift)**

Cutting immediately stops and returns to X(Z) coordinate at cycle start.

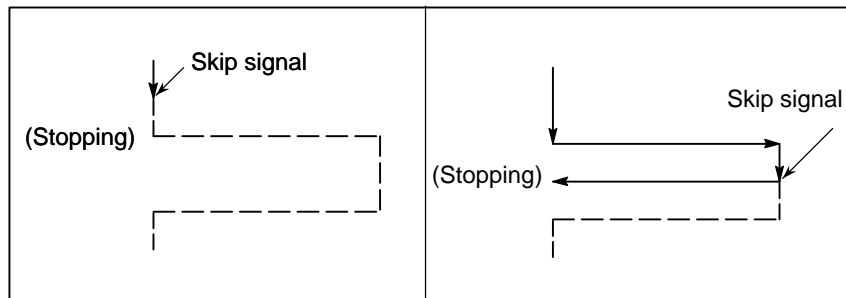

- **Case of during operation sequence ② and ⑤ (during dwell)**

Dwell immediately stops and returns to X(Z) coordinate at cycle start.

- **Case of during operation sequence ③ and ⑥ (when X(Z) shifts)**

After shift of X(Z) has finished, returns to X(Z) coordinate at cycle start.

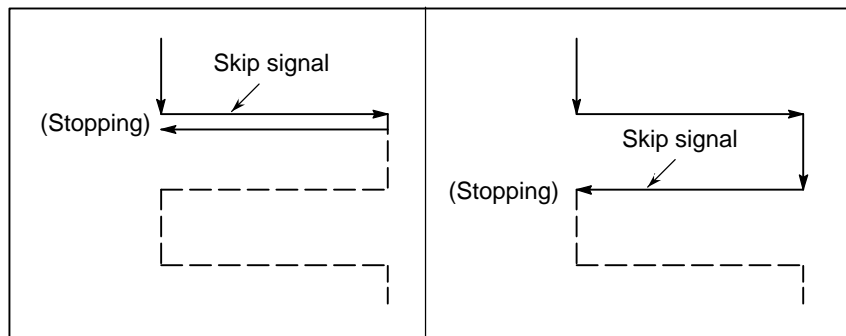

13.14.3 Continuous Feed Plane Grinding Cycle (G78)

The continuous feed plane grinding cycle is possible by the following command.

Format

G78 I_ (J)_ K_ X_ R_ F_ P_ L_ ;

- I : Cutting depth (Cutting direction is by command coding.)
- J : Cutting depth (Cutting direction is by command coding.)
- K : Total cutting depth
- X : Grinding range (Grinding direction is by command coding.)
- F : Feed rate
- P : Dwell time
- L : Grindstone wear compensation number (Note 1)

Note 1) L is specified when performing continuous dressing.

Note 2) X, I, J and K commands are all incremental commands.

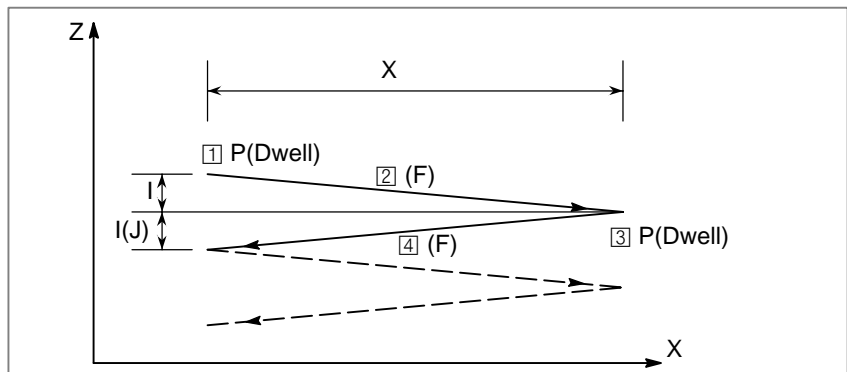

The continuous feed plane grinding cycle is made up from the following sequence of 4 operations.

The operations from ① up to ④ are repeated until the grindstone cutting depth reaches the total cutting depth specified by address K.

- ① Dwell
- ② Grinding
- ③ Dwell
- ④ Grinding (return direction)

In case of single block, the operation from ① to ④ are performed by one cycle start.

NOTE

When J is not commanded, it is regarded as J=1.

Further, the J command effective only at the specified block.

It does not remain as modal information. (Irrespective of "J" of G75, G77, and G79)

When cutting by I or J, in the case the total cutting depth is reached, the cycle finishes after the following sequence of operations (up to 4) has been executed. The cutting depth in this case reaches the total cutting depth position.

- When total cutting depth is reached by cutting operation of I or J.

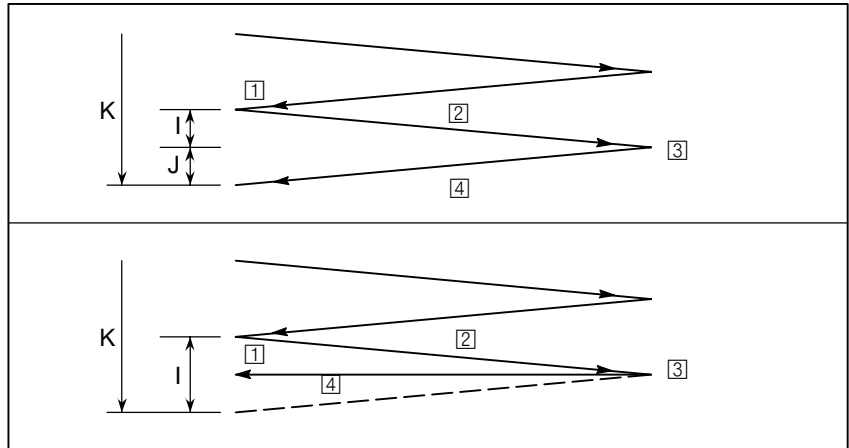

- When the total cutting depth is reached in the middle of cutting of I or J.

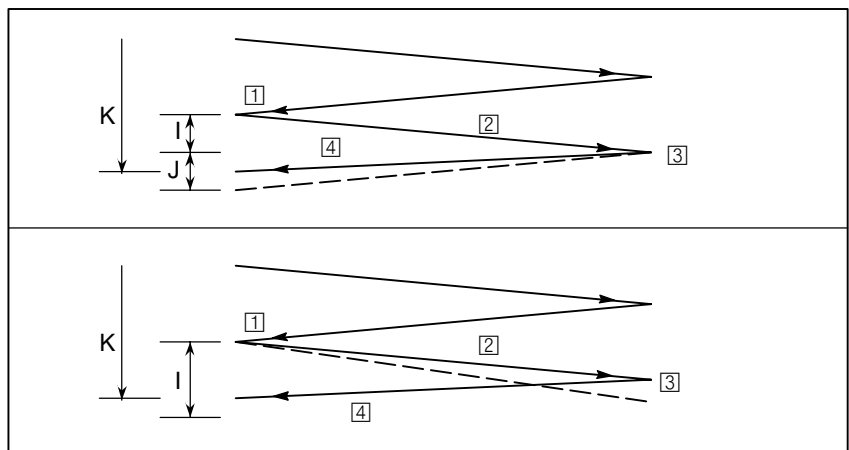

13.14.4 Intermittent Feed Plane Grinding Cycle (G79)

Format

The intermittent feed plane grinding cycle is possible by the following command.

G79 I_ J_ K_ X_ R_ F_ P_ L_ ;

- I : The first cutting depth (Cutting direction is by command coding.)
- J : The second cutting depth
(Cutting direction is by command coding.)
- K : Total cutting depth
- X : Grinding range (Grinding direction is by command coding.)
- R : Feed rate of I and J
- F : Feed rate of X
- P : Dwell time
- L : Grindstone wear compensation number (Note 1)

Note 1) L is specified when performing continuous dressing.

Note 2) I, J, K and X commands are all incremental commands.

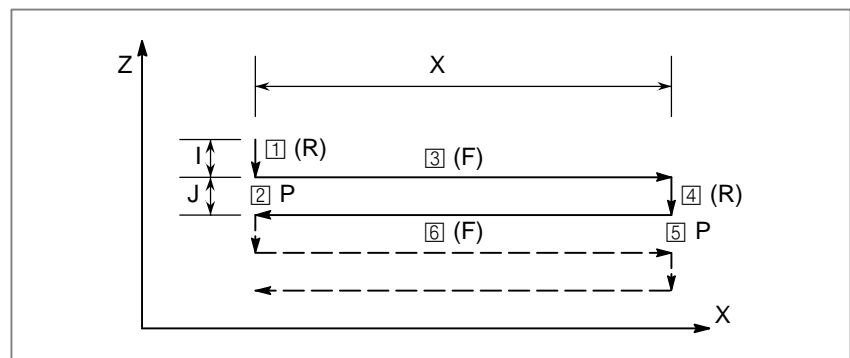

The intermittent feed plane grinding cycle is made up from the following sequence of 6 operations.

The operations from ① up to ⑥ are repeated until the grindstone cutting depth reaches the total cutting depth specified by address K.

① Grindstone cutting :

Cuts in Z axis direction by cutting feed only the amount specified by the first cutting depth I. The feed rate becomes the rate specified by R.

② Dwell :

Performs dwell for only the time specified by P.

③ Grinding :

Shifts by cutting feed only the amount specified by X in the X axis direction. The feed rate becomes the rate specified by F.

④ Grindstone cutting :

Cuts in Z axis direction by cutting feed only the amount specified by the second cutting depth J. The feed rate becomes the rate specified by R.

⑤ Dwell :

Performs dwell for only the time specified by P.

⑥ Grinding (return direction) :

Sent at rate specified by F in the reverse direction only the amount specified by X.

In the case of a single block, the operations from ① to ⑥ are performed by one cycle start.

13.15 **M series** INFEEED CONTROL

Controls cutting a certain fixed amount along the programmed figure for input of external signals at the swing end point.

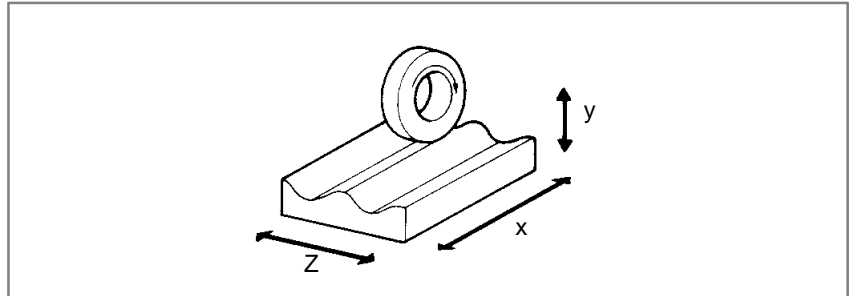

Format

G161 R_ ;

Figure program

G160 ;

- G161R_ : Commands the operation mode and start of start of figure program. Further, specifies the cutting depth by address R.
- Figure program : Programs the workpiece figure in the Y-Z plane by either linear interpolation (G01) or by circular interpolation (G02, G03). Multiple blocks can be commanded.
- G160 : Commands cancelling of operation mode (ending of figure program).

13.16 **M series** FIGURE COPYING (G72.1, G72.2)

The repeat cutting can be made by the rotation or translation of a figure commanded with a sub program.

The plane for figure copying is selected by the plane selection commands of G17, G18, and G19.

NOTE

The rotation copy cannot be commanded in the subprogram which commanded a rotation copy. Similarly, the translation copy cannot be further commanded in a subprogram which commanded a translation copy.

However, the translation copy and rotation copy can be commanded in the subprograms which commanded the rotation copy and translation copy, respectively.

13.16.1 Rotation Copy (G72.1)

The repeat cutting can be made by the rotation of a figure commanded with a sub program using the following commands :
Select the plane on which rotational copy will be performed, using plane selection commands G17, G18, and G19.

Format

G17 G72.1 P_ L_ Xp_ Yp_ R_ ; Xp-Yp plane

G18 G72.1 P_ L_ Zp_ Xp_ R_ ; Zp-Xp plane

G19 G72.1 P_ L_ Yp_ Zp_ R_ ; Yp-Zp plane

P : Sub program number

L : Number of repetitions

Xp : Xp axis center coordinate of rotation
(Xp : X axis or the axis which is parallel to X axis)

Yp : Yp axis center coordinate of rotation
(Yp : Y axis or the axis which is parallel to Y axis)

Zp : Zp axis center coordinate of rotation
(Zp : Z axis or the axis which is parallel to Z axis)

R : Rotation angle (+ = Counterclockwise direction)

Examples

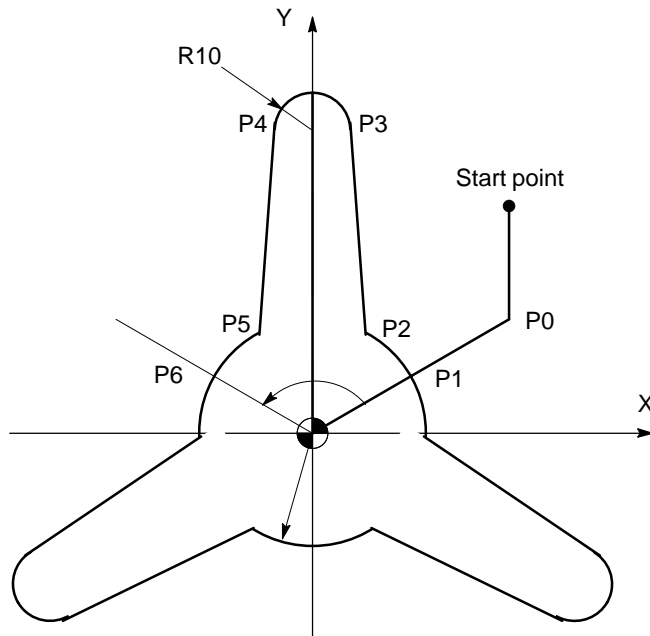

Main program

```
O1000 ;
N10 G92 X40.0 Y50.0 ;
N20 G00 G90 X_ Y_ ;
N30 G01 G17 G41 X_ Y_ D01 F10 ; (P1)
N40 G72.1 P2000 L3 X0 Y0 R120.0 ;
N50 G40 G01 X_ Y_ I_ J_ ;
N60 G00 X40.0 Y50.0 ;
N70 M30 ;
```

Sub program

```
O2000 G03 X_ Y_ R30.0 ; (P2)
N100 G01 X_ Y_ ; (P3)
N200 G03 X_ Y_ R10.0 ; (P4)
N300 G01 X_ Y_ ; (P5)
N400 G03 X_ Y_ R30.0 ; (P6)
N500 M99 ;
(P0)
```

13.16.2 Linear Copy (G72.2)

The repeat cutting can be made by the translation of a figure commanded with a sub program using the following commands :
Select the plane of linear copy with the plane selection commands G17, G18, and G19.

Format

G17 G72.2 P_ L_ I_ J_ ; Xp-Yp plane
G18 G72.2 P_ L_ K_ I_ ; Zp-Xp plane
G19 G72.2 P_ L_ J_ K_ ; Yp-Zp plane

P : Sub program number
 L : Number of repetitions
 I : Shift amount in Xp direction
 J : Shift amount in Yp direction
 K : Shift amount in Zp direction

Examples

Main program	Sub program
O1000 ;	O2000 G90 G01 X_ ; (P3)
N10 G92 X-20.0 Y0 ;	N100 Y_ ; (P4)
N20 G00 G90 X0 Y0	N200 G02 X_ L_ ; (P5)
N30 G01 G17 G41 X_ Y_ D01 F10 ; (P0)	N300 G01 Y_ (P6)
N40 Y_ ; (P1)	N400 X_ ; (P7)
N50 X_ ; (P2)	N500 M99 ;
N60 G72.2 P2000 L3 I70.0 J0 ;	
N70 X_ Y_ ; (P8)	
N80 X0 ;	
N90 G00 G40 X-20.0 Y0 ;	
N100 M30 ;	

14

TOOL COMPENSATION FUNCTION



14.1 T series TOOL OFFSET

14.1.1 Tool Offset (T Code)

By using this function, shift amount between the reference position assumed when programming and the actual tool position when machining, can be set as tool offset amount, thus allowing workpiece machining according to the programmed size without changing the program.

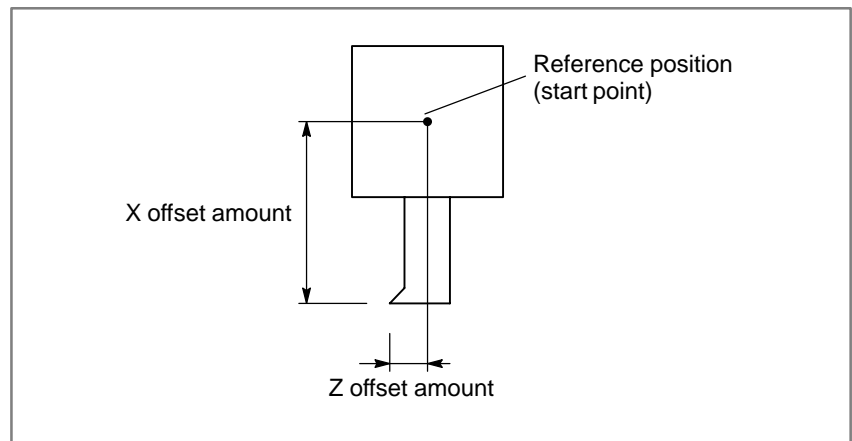

The tool offset can be commanded to X, Y, and Z axes.

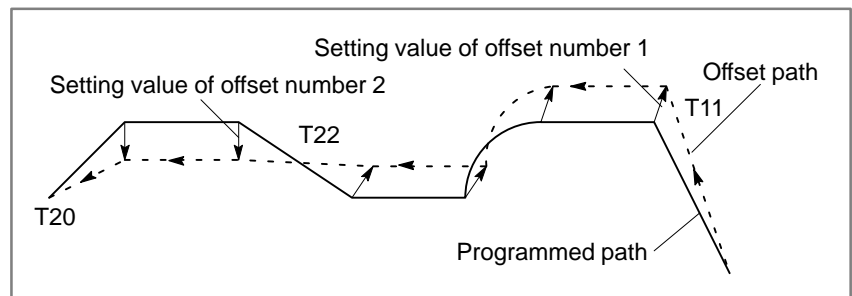

Explanations

- Offset number

The offset number is specified in the last one or two digit of the T code. Use parameters to select offset number digits (one or two).

- When offset number is specified with one digit

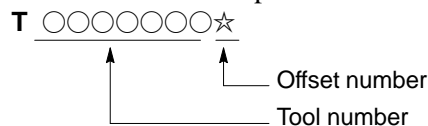

- When offset number is specified with two digits

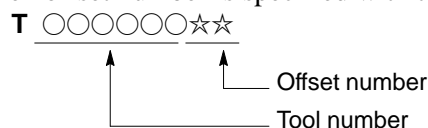

When the offset number is specified, the corresponding offset amount is selected, and tool offset starts.

When 0 is selected as offset number, the tool offset is canceled.

14.1.2 Tool Geometry Compensation and Tool Wear Compensation

The tool geometry compensation function compensates the tool figure or tool mounting position. The tool wear compensation function compensates the wear of a tool tip. These compensation amounts (offset values) can be set separately. There are two types of geometry compensation: So-called geometry compensation and the second geometry compensation that allows the user to specify whether to use the direction directed by the PMC. The second geometry compensation is used to compensate for the difference in tool mounting position or selected position. If distinction between them is not necessary, the total value of them is set as a tool position offset value.

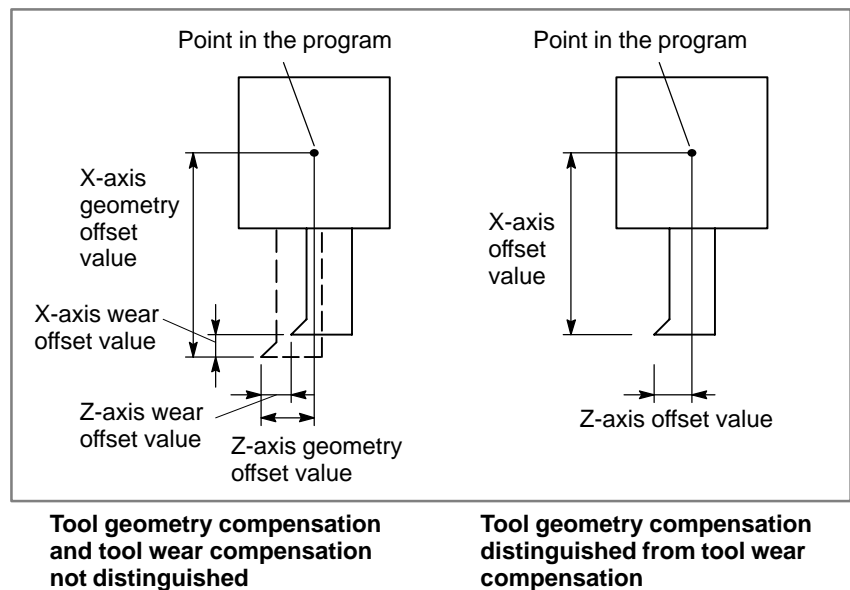

14.1.3 Y Axis Offset

In the system in which the Y axis is the fourth axis, the Y axis can be compensated by the tool offset value. When the tool geometry/wear compensation option is specified, tool geometry/wear compensation is valid for the Y-axis offset.

NOTE

- 1 To use the Y-axis offset, the Y axis must be a linear axis.
- 2 The direct input function of tool offset value or direct input B function of tool compensation amount measured value cannot be used for the Y-axis offset.

14.2 **T series** TOOL NOSE RADIUS COMPENSATION (G40, G41, G42)

With this function, the programmed tool path can be offset when actually machining, for value of the tool radius set in the CNC.

By programming machining pattern using this function (measuring cutter radius for actual cutting, and setting the value in the CNC as offset value), the tool can machine the programmed pattern, via the offset path. There is not need to change the program even when tool radius changes; just change the offset value.

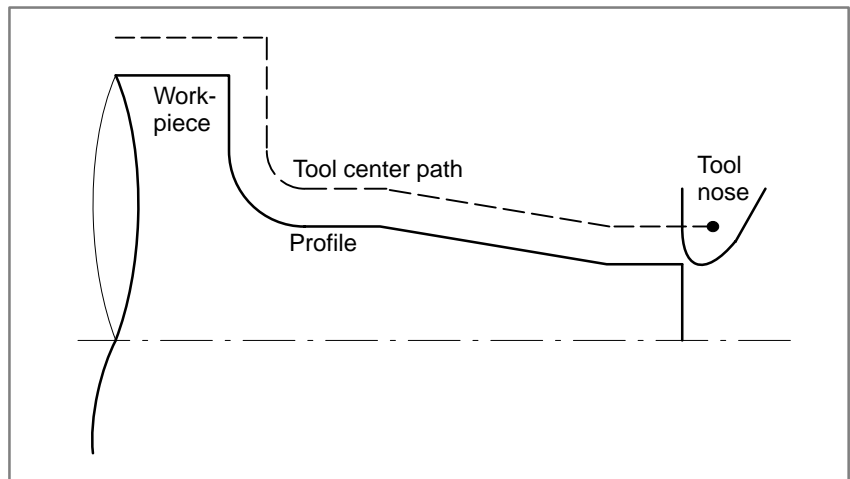

Cross points of line and line, arc and arc, line and arc is automatically calculated in the CNC to obtain offset actual tool path. So, Programming becomes simple, because it is only necessary to program the machining pattern.

Explanations

- **Tool nose radius compensation and its cancellation (G40, G41, G42)**

G40 : Tool nose radius compensation cancel

G41 : Tool nose radius compensation left

G42 : Tool nose radius compensation right

G41 and G42 are commands for tool nose radius compensation mode.

The tool is offset to the left forward in the tool movement in G42 and right forward in G42. Tool nose radius compensation is cancelled with G40.

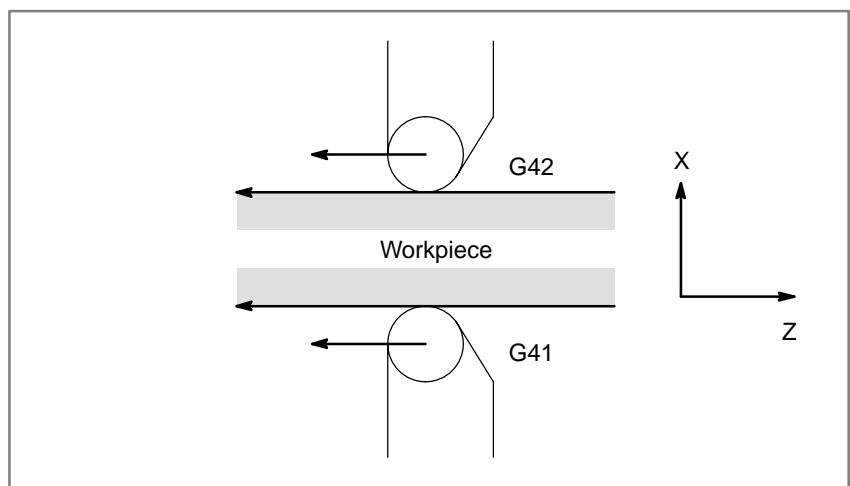

● **Imaginary tool nose**

The tool nose at position A in the following figure does not actually exist. The imaginary tool nose is required because it is usually more difficult to set the actual tool nose center to the start point than the imaginary tool nose. Also when imaginary tool nose is used, the tool nose radius need not be considered in programming.

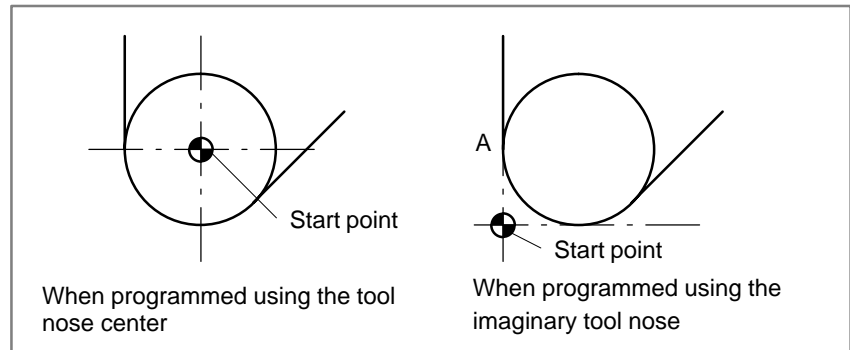

The position relationship when the tool is set to the start point is shown in the following figure. The point of tool nose for start point or reference point is set in offset memory same as tool nose radius compensation amount.

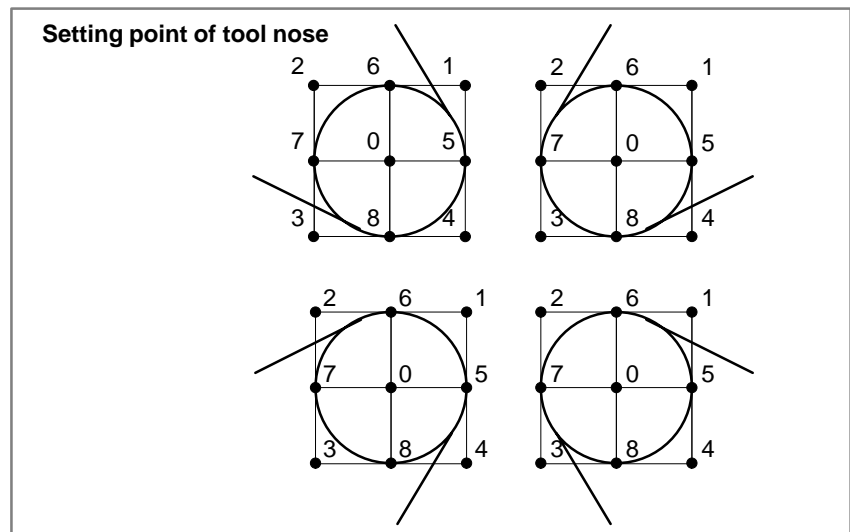

● **Tool nose radius compensation amount and assignment of imaginary tool nose point (T code)**

Tool nose radius compensation amount and imaginary tool nose point can be set in the tool nose radius compensation memory. When the last one or two digits of T code is commanded as offset number, corresponding tool nose radius compensation amount and imaginary tool nose point in the tool compensation memory is applied as the tool nose radius compensation amount and imaginary tool nose point for cutter radius compensation.

● **Plane selection
(G17, G18, G19)**

Cutter radius compensation is done on XY, ZX, YZ planes and on parallel axes of X, Y, Z axes.

Plane to perform tool nose radius compensation is selected with G17, G18, G19.

G17 : Xp-Yp plane Xp : X axis or the parallel axis

G18 : Zp-Xp plane Yp : Y axis or the parallel axis

G19 : Yp-Zp plane Zp : Z axis or the parallel axis

Parameters are used to set which parallel axis of the X, Y, Z axes is to be the additional axis.

● **Interference check**

Tool overcutting is called 'interference'. This function checks whether interference occurs, if tool nose radius compensation is performed.

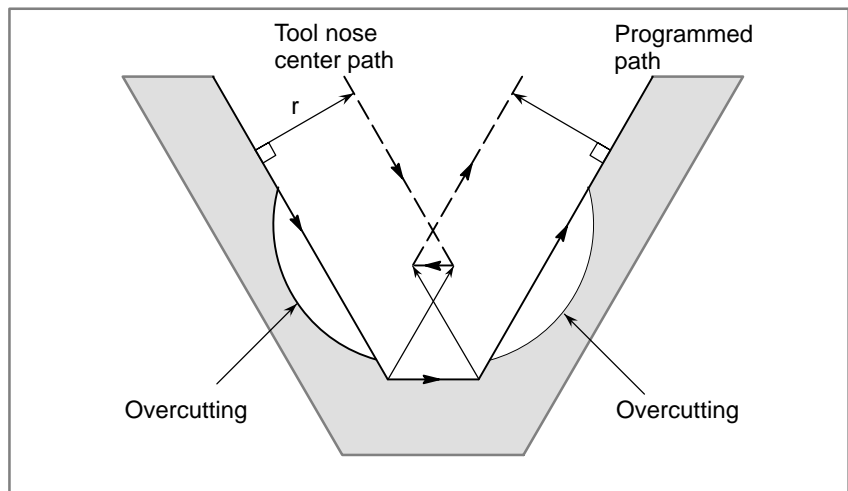

14.3 **T series**
**CORNER CIRCULAR
INTERPOLATION
FUNCTION (G39)**

During radius compensation for the tool tip, corner circular interpolation, with the specified compensation value used as the radius, can be performed by specifying G39 in offset mode.

Format

in offset mode, specify

G39 ;
or $\left\{ \begin{matrix} I_ J_ \\ I_ K_ \\ J_ K_ \end{matrix} \right\}$

14.4 M series TOOL LENGTH COMPENSATION (G43, G44, G49)

By setting the difference between tool length assumed when programming and the actual tool length as offsets, workpiece can be machined according to the size commanded by the program, without changing the program.

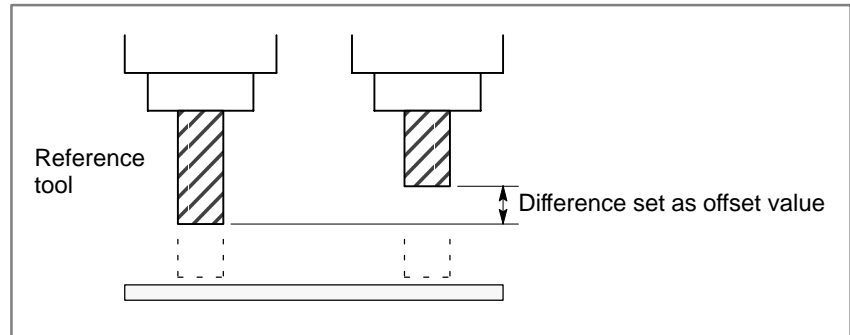

Explanations

- **Tool length compensation and its cancellation (G43, G44, G49)**

G43 : Tool length compensation +
G44 : Tool length compensation -
G49 : Tool length compensation cancel

In G43 mode, the tool is offset to the + direction for the preset tool length offset amount. In G44 mode, it is offset to the - direction for the preset tool length offset amount. G49 cancels tool length compensation.

- **Tool length compensation axis**

Tool length compensation can be performed for three types of axes. Compensation for the Z axis is tool length compensation A. That for the axis vertical to the selected plane is tool length compensation B. That for the axis specified by the G43 or G44 block is tool length compensation C. Which compensation to perform can be selected by a parameter.

- **Assignment of offset amount (H code)**

The offset amount can be set in the tool length compensation memory. By specifying an offset number with the H code, offset amount loaded in corresponding tool length compensation memory is used as tool length compensation amount.

Format

<p>Tool length compensation A</p> $\left\{ \begin{array}{l} \mathbf{G43} \\ \mathbf{G44} \end{array} \right\} \mathbf{H}_;$ <p>Tool length compensation B</p> $\left\{ \begin{array}{l} \mathbf{G17} \\ \mathbf{G18} \\ \mathbf{G19} \end{array} \right\} \left\{ \begin{array}{l} \mathbf{G43} \\ \mathbf{G44} \end{array} \right\} \mathbf{H}_;$ <p>Tool length compensation C</p> $\left\{ \begin{array}{l} \mathbf{G43} \\ \mathbf{G44} \end{array} \right\} \alpha_ \mathbf{H}_; \text{ (alpha: arbitrary 1 axis)}$
--

14.5 M series TOOL OFFSET (G45, G46, G47, G48)

Explanations



- G45, G46, G47, G48

The programmed tool movement can be expanded or reduced for offset amount preset in the tool length compensation memory, by using this function.

- G45: Tool offset expansion
- G46: Tool offset reduction
- G47: Tool offset double expansion
- G48: Tool offset double reduction

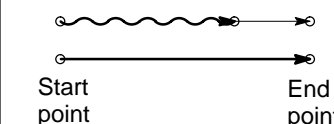
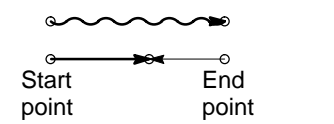
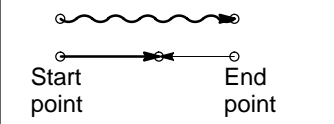
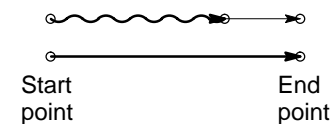
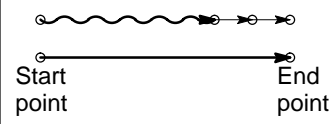
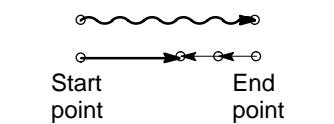
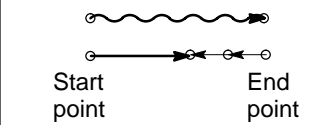
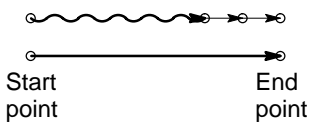
By commanding G45 - G48, expansion, reduction, double expansion, double reduction to axis move commanded in the program can be performed for the offset amount preset in the tool length compensation memory. The same offset amount is applied to all move command axes in the same block as G45 - G48.

G code	Tool offset value is positive	Tool offset value is negative
G45		
G46		
G47		
G48		

-  Movement distance
-  Tool offset value
-  Actual movement distance

- **Assignment of offset amount (D code)**

The offset amount can be set in the tool length compensation memory. By commanding an offset number with the D code, offset amount corresponding to the number in the tool length compensation memory is used as tool offset amount.

14.6**M series****CUTTER
COMPENSATION****14.6.1****Cutter Compensation B
(G40 - G42)**

With cutter compensation B, inside of the sharp angle cannot be cut. In this case, an arc larger than the cutter radius can be commanded to the corner by programming. Other functions are same as cutter radius compensation C.

14.6.2**Cutter Compensation C
(G40 - G42)**

With this function, the programmed tool path can be offset when actually machining, for value of the tool radius set in the CNC. By measuring cutting radius for actual cutting, and setting the value in the CNC as offset value, the tool can machine the programmed pattern, via the offset path. There is no need to change the program even when tool radius changes; just change the offset value.

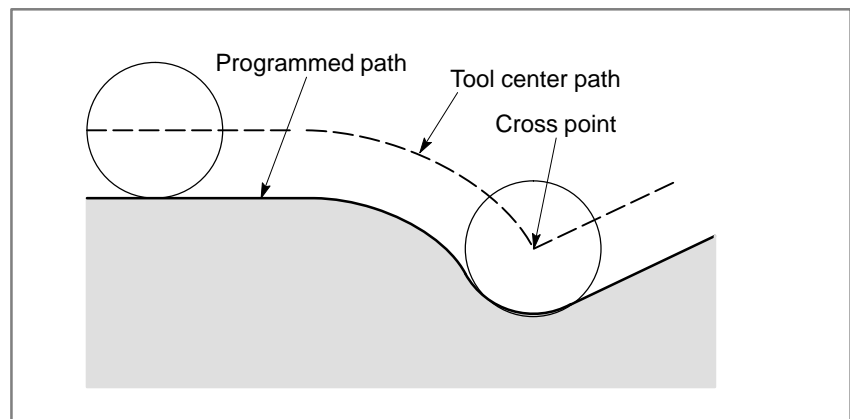

Cross points of line and line, arc and arc, line and arc is automatically calculated in the CNC to obtain offset actual tool path. So, programming becomes simple, because it is only necessary to program the machining pattern.

- **Cutter compensation and its cancellation (G40, G41, G42)**

G40 : Cutter radius compensation cancel

G41 : Cutter radius compensation left

G42 : Cutter radius compensation right

G41 and G42 are commands for cutter radius compensation mode. The cutter is offset to the left forward in the cutter movement in G41 and right forward in G42. Cutter radius compensation is cancelled with G40.

- **Assignment of offset amount (D code)**

The offset amount can be set in the cutter radius compensation memory. When the D code is commanded as an offset number, corresponding offset amount in the tool compensation memory is applied as the offset amount for cutter radius compensation.

The offset can be specified with an H code when the parameter is set accordingly.

- **Plane selection
(G17, G18, G19)**

Cutter radius compensation is done on XY, ZX, YZ planes and on parallel axes of X, Y, Z axes.

Plane to perform cutter radius compensation is selected with G17, G18, G19.

G17 : Xp-Yp plane

G18 : Zp-Xp plane

G19 : Yp-Zp plane

where

Xp : X axis or its parallel axis

Yp : Y axis or its parallel axis

Zp : Z axis or its parallel axis

Parameters are used to set which parallel axis of the X, Y, Z axes is to be the additional axis.

Plane to perform cutter radius compensation is decided in the axis address commanded in the G17, G18, or G19 block.

Example)

(U, V, W axes are parallel axes of X, Y, Z axes respectively)

G17 X_ ; XY plane

G17 U_ W_ ; UV plane

G19 Y_ W_ ; YW plane

If axis address of Xp, Yp, or Zp was omitted, compensation plane is decided regarding that X, Y, or Z was omitted.

- **Interference check**

Tool overcutting is called 'interference'. This function checks whether interference occurs, if cutter radius compensation is performed.

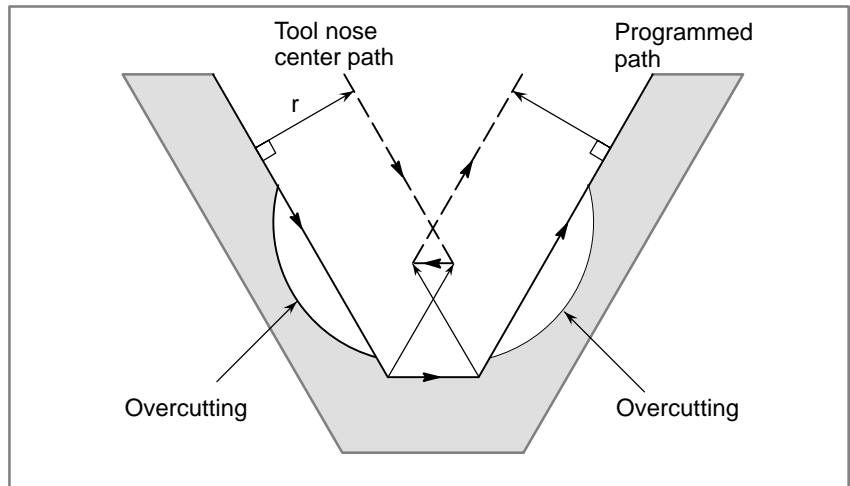

14.7 **M series** CORNER CIRCULAR INTERPOLATION FUNCTION (G39)

During cutter compensation B, C, corner circular interpolation, with the specified compensation value used as the radius, can be performed by specifying G39 in offset mode.

- **Cutter compensation B**

in offset mode, specify

G39 $\left\{ \begin{array}{l} X_ Y_ \\ X_ Z_ \\ Y_ Z_ \end{array} \right\} ;$

or

G39 $\left\{ \begin{array}{l} I_ J_ \\ I_ K_ \\ J_ K_ \end{array} \right\} ;$

- **Cutter compensation C**

in offset mode, specify

G39 ;

or

G39 $\left\{ \begin{array}{l} I_ J_ \\ I_ K_ \\ J_ K_ \end{array} \right\} ;$

14.8 TOOL COMPENSATION MEMORY

14.8.1 **M series** Tool Compensation Memory

One of the tool compensation memory A/B/C can be selected according to offset amount.

Tool offset amount range which can be set is as follows:

Increment system	Geometry compensation		Tool wear compensation	
	Metric input	Inch input	Metric input	Inch input
IS-B	±999.999mm	±99.9999inch	±99.999mm	±9.9999inch
IS-C	±999.9999mm	±99.9999inch	±99.9999mm	±9.99999inch

Explanations

- **Tool compensation memory A**

There is no difference between geometry compensation memory and tool wear compensation memory in this tool compensation memory A. Therefore, amount of geometry offset and tool wear offset together is set as the offset memory. There is also no differences between cutter radius compensation (D code) and tool length compensation (H code).

Example

Offset number	Compensation (geometry+wear)	D code/H code common
001	10.0	For D code
002	20.0	For D code
003	100.0	For H code

- **Tool compensation memory B**

Memory for geometry compensation and tool ware compensation is prepared separately in tool compensation memory B. Geometry compensation and tool wear compensation can thus be set separately. There is no difference between cutter radius compensation (D code) and tool length compensation (H code).

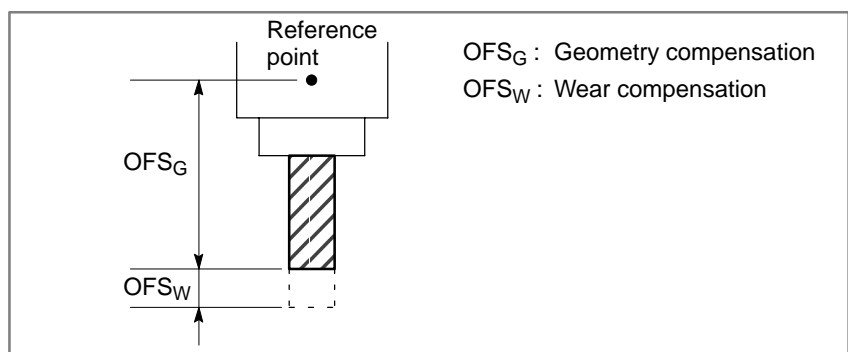

Example

Offset number	Geometry compensation	Wear compensation	D code/H code common
001	10.1	0.1	For D code
002	20.2	0.2	For D code
003	100.0	0.1	For H code

● **Tool compensation memory C**

Memory for geometry compensation as well as tool wear compensation is prepared separately in tool compensation memory C. Geometry compensation and tool wear compensation can thus be set separately. Separate memories are prepared for cutter radius compensation (for D code) and for tool length compensation (for H code).

Example

Offset number	For D code		For H code	
	Geometry compensation	Wear compensation	Geometry compensation	Wear compensation
001	10.0	0.1	100.0	0.1
002	20.0	0.2	300.0	0.3

14.8.2 **T series**
Tool Offset Amount Memory

There are two types of tool offset amount memory, which can be selected according to offset amount.

Tool offset amount range which can be set is as follows:

Increment system	Tool compensation value	
	Metric input (mm)	Inch input (inch)
IS-B	-999.999 to +999.999	-99.9999 to +99.9999
IS-C	-999.9999 to +999.9999	-99.99999 to +99.99999

The maximum wear compensation value can, however, be modified using a parameter.

The number of digits used to specify a tool geometry/wear compensation value can be expanded by selecting the option which enables seven-digit tool offset specification. When this option is used, tool compensation values can be specified using up to seven digits for IS-B and eight digits for IS-C. The valid data range for tool compensation values will thus be as listed in the following table.

Increment system	Tool compensation value	
	Metric input (mm)	Inch input (inch)
IS-B	0 to ±9999.999	0 to ±999.9999
IS-C	0 to ±9999.9999 (0 to ±4000.0000)	0 to ±999.99999 (0 to ±160.00000)

NOTE

- 1 The range enclosed in parentheses applies when automatic inch/metric conversion is enabled.
- 2 The option enabling seven-digit tool offset specification cannot be used for B-axis offsets for B-axis control.

Explanations

- **Tool geometry/wear compensation option not specified**

No distinction is made between the memory for geometry compensation values and that for wear compensation values. The total of the geometry compensation value and wear compensation value for a tool is stored in compensation memory.

Example

Offset number	X axis offset amount	Z axis offset amount	Y axis offset amount	Amount of tool nose compensation	Imaginary tool nose number
01	10.0	100.1	0	0.5	3
02	20.2	150.3	0	0.7	2
03	30.4	200.5	0	1.0	8

- **Tool geometry/wear compensation option specified**

Memory for geometry offset and tool wear offset is prepared separately. Geometry offset and tool wear offset can thus be set separately.

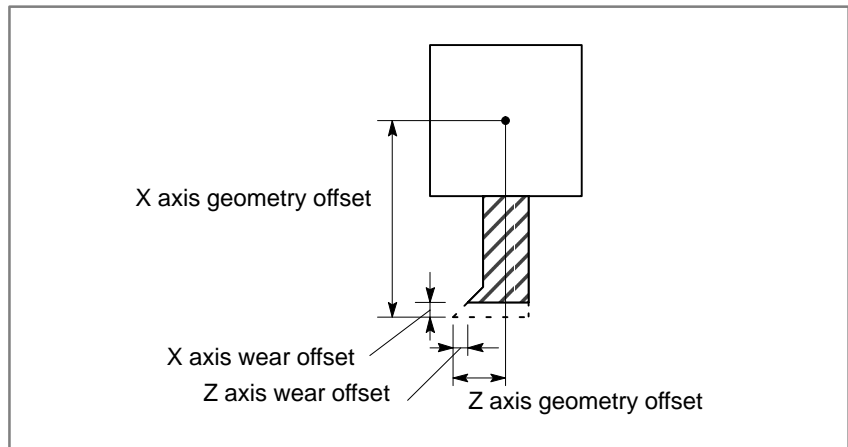

Offset number	X axis offset value		Z axis offset value		Y axis offset value		Tool nose radius compensation value		Imaginary tool nose number
	Geometry offset	Wear offset	Geometry offset	Wear offset	Geometry offset	Wear offset	Geometry offset	Wear offset	
01	10.0	0.0	100.0	0.1	0	0	0.4	0.1	3
02	20.2	0.2	150.0	0.3	0	0	0.5	0.2	2
03	30.4	0.4	200.0	0.5	0	0	1.2	-0.2	8

14.9 NUMBER OF TOOL OFFSETS

14.9.1

M series

Number of Tool Offsets

- **32 tool offsets (standard)**
Offset numbers (D code/H code) 0 - 32 can be used.
D00 - D32, or H00 - H32
- **64 tool offsets (optional)**
Offset numbers (D code/H code) 0 - 64 can be used.
D00 - D64, or H00 - H64
- **99 tool offsets (optional)**
Offset numbers (D code/H code) 0 - 99 can be used.
D00 - D99, or H00 - H99
- **200 tool offsets (optional)**
Offset numbers (D code/H code) 0 - 200 can be used.
D00 - D200, or H00 - H200
- **400 tool offsets (optional)**
Offset numbers (D code/H code) 0 - 400 can be used.
D00 - D400 or H00 - H400
- **499 tool offsets (optional)**
Offset numbers (D code/H code) 0 - 499 can be used.
D00 - D499, or H00 - H499
- **999 tool offsets (optional)**
Offset numbers (D code/H code) 0 - 999 can be used.
D00 - D999 or H00 - H999

14.9.2

T series

Number of Tool Offsets

- **16 tool offsets (standard)**
Offset numbers 0 - 16 can be used.
- **32 tool offsets (optional)**
Offset numbers 0 - 32 can be used.
- **64 tool offsets (optional)**
Offset numbers 0 - 64 can be used.
- **99 tool offsets (optional)**
Offset numbers 0 - 99 can be used.
- **400 tool offsets (optional)**
Offset numbers 0 - 400 can be used.
- **999 tool offsets (optional)**
Offset numbers 0 - 999 can be used.

NOTE

- 1 For the tool post interference check (between two paths), up to 64 tool offsets can be displayed or set for tool figure data.
- 2 For 400 or 999 tool offsets, the tool offset number is specified for the three low-order digits of the T code.

14.10 CHANGING OF TOOL OFFSET AMOUNT (PROGRAMMABLE DATA INPUT) (G10)

Tool offset amount can be set/changed with the G10 command.

When G10 is commanded in absolute input (G90), the commanded offset amount becomes the new tool offset amount. When G10 is commanded in incremental input (G91), the current tool offset amount plus the commanded offset amount is the new tool offset amount.

Format (M series)

- Tool compensation memory A

G10 L11 P_ R_ ;

P_ : Offset number
R_ : Tool offset amount

- Tool compensation memory B

Setting/changing of geometry offset amount

G10 L10 P_ R_ ;

Setting/changing of tool wear offset amount

G10 L11 P_ R_ ;

- Tool compensation memory C

Setting/changing of geometry offset amount for H code

G10 L10 P_ R_ ;

Setting/changing of geometry offset amount for D code

G10 L12 P_ R_ ;

Setting/changing of tool wear offset amount for H code

G10 L11 P_ R_ ;

Setting/changing of tool ware offset amount for D code

G10 L13 P_ R_ ;

NOTE

L1 may be used instead of L11 for the compatibility with the conventional CNC's format.

Format (T series)**G10 P_ X_ Y_ Z_ R_ Q_ ;**

or

G10 P_ U_ V_ W_ C_ Q_ ;

P : Offset number

1-64 :Tool wear offset number

10000+(1-64) : Tool geometry offset number+10000

X : Offset value on X axis (absolute)

Y : Offset value on Y axis (absolute)

Z : Offset value on Z axis (absolute)

U : Offset value on X axis (incremental)

V : Offset value on Y axis (incremental)

W : Offset value on Z axis (incremental)

R : Tool nose radius offset value (absolute)

C : Tool nose radius offset value (incremental)

Q : Imaginary tool nose number

In an absolute command, the values specified in addresses X, Y, Z, and R are set as the offset value corresponding to the offset number specified by address P. In an incremental command, the value specified in addresses U, V, W, and C is added to the current offset value corresponding to the offset number.

NOTE

- 1 Addresses X, Y, Z, U, V, and W can be specified in the same block.
- 2 Use of this command in a program allows the tool to advance little by little. This command can also be used input offset values one at a time from a tape by specifying this command successively instead of inputting these values one at a time from the MDI unit.

14.11 **M series** GRINDING-WHEEL WEAR COMPENSATION BY CONTINUOUS DRESSING

The grinding-wheel cutting and dresser cutting are compensated continuously during grinding in the canned cycles for surface grinding (G75, and G77 to G79). They are compensated according to the amount of continuous dressing.

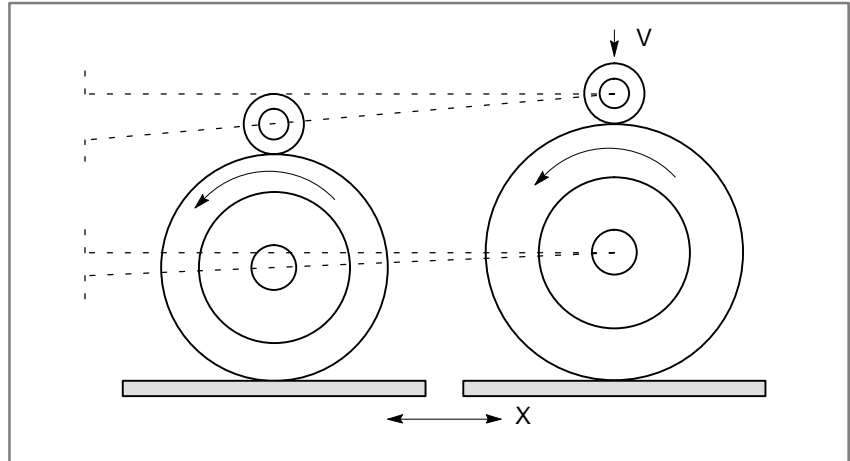

Explanations

- **Specification**

The offset number (grinding-wheel wear compensation number) is specified by address L in the block for the canned cycles for surface grinding. The compensation amount set in the offset memory corresponding to the specified number is the dressing amount.

- **Compensation**

Compensation is performed for each cutting operation (each X-axis movement) in the canned cycles for grinding. Along with X-axis movement, compensation is performed both in Y-axis direction (grinding-wheel cutting) and that in V-axis direction (dresser cutting). That is, compensation is performed for interpolation for the three coordinates simultaneously. The Y-axis movement amount (compensation amount) is the specified dressing amount. The V-axis movement amount is twice the specified dressing amount (diameter).

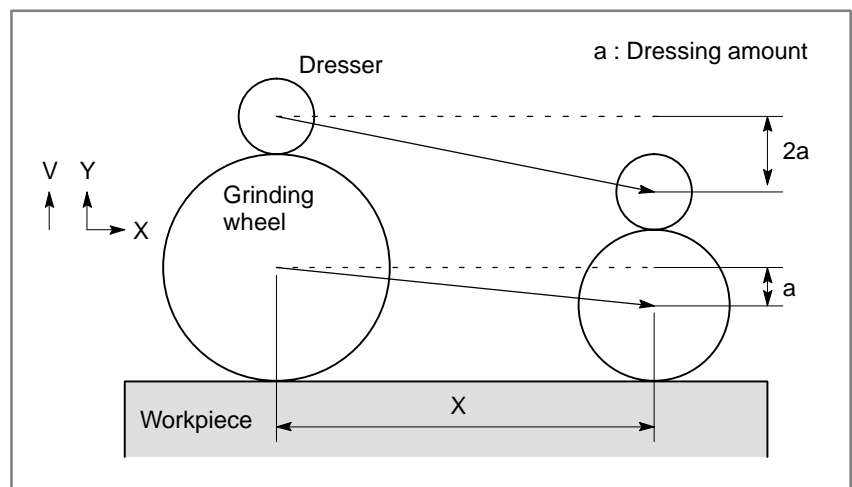

14.12 **M series** THREE- DIMENSIONAL TOOL COMPENSATION (G40, G41)

In cutter compensation C, two-dimensional offsetting is performed for a selected plane. In three-dimensional tool compensation, the tool can be shifted three-dimensionally when a three-dimensional offset direction is programmed.

Format

- **Start-up
(Starting
three-dimensional tool
compensation)**

When the following command is executed in the cutter compensation cancel mode, the three-dimensional tool compensation mode is set :

G41 Xp_ Yp_ Zp_ I_ J_ K_ D_ ;

Xp : X-axis or a parallel axis

Yp : X-axis or a parallel axis

Zp : Z-axis or a parallel axis

- **Canceling
three-dimensional tool
compensation**

When the following command is executed in the three-dimensional tool compensation mode, the cutter compensation cancel mode is set :

When canceling the three-dimensional tool compensation mode and tool movement at the same time

G40 Xp_ Yp_ Zp_ ;

or

Xp_ Yp_ Zp_ D00 ;

When only canceling the vector

G40 ;

or

D00 ;

- **Selecting offset space**

The three-dimensional space where three-dimensional tool compensation is to be executed is determined by the axis addresses specified in the start-up block containing the G41 command. If Xp, Yp, or Zp is omitted, the corresponding axis, X-, Y-, or Z- axis (the basic three axis), is assumed.

(Example)

When the U-axis is parallel to the X-axis, the V-axis is parallel to the Y-axis, and the W-axis is parallel to the Z-axis

G41 X_ I_ J_ K_ D_ ; XYZ space

G41 U_ V_ Z_ I_ J_ K_ D_ ; UVZ space

G41 W_ I_ J_ K_ D_ ; XYW space

14.13 **M series**
**GRINDING WHEEL
 WEAR
 COMPENSATION
 (G40, G41)**

The grinding wheel compensation function creates a compensation vector by extending the line between the specified compensation center and the specified end point, on the specified compensation plane.

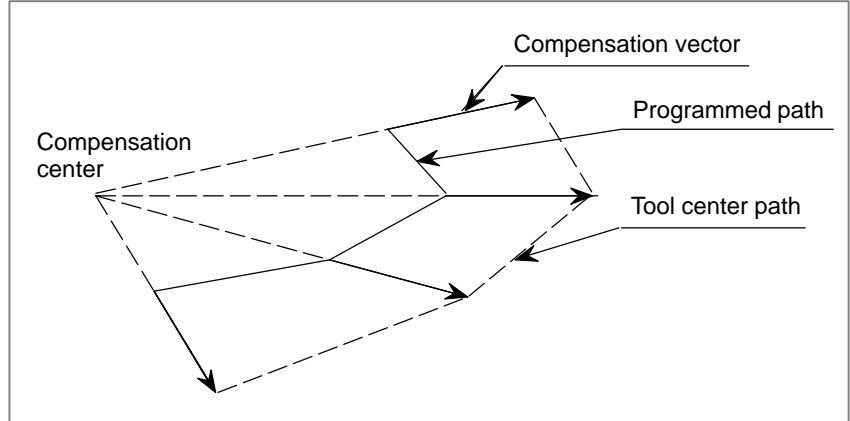

Format

- **Selecting the compensation center**

- **Start-up**

- **Canceling compensation mode**

- **Holding the compensation vector**

<p>G41 Pn (n=1, 2, 3);</p> <p style="margin-left: 20px;">G41 P1; Select the first compensation center</p> <p style="margin-left: 20px;">G41 P2; Select the second compensation center</p> <p style="margin-left: 20px;">G41 P3; Select the third compensation center</p>
<p>D_; D code other than 0</p>
<p>D0;</p>
<p>G40;</p>

14.14 TOOL AXIS DIRECTION TOOL LENGTH COMPENSATION

When a five-axis machine that has two axes for rotating the tool is used, tool length compensation can be performed in a specified tool axis direction on a rotation axis. When a rotation axis is specified in tool axis direction tool length compensation mode, tool length compensation is applied in a specified tool axis direction on the rotation axis by the compensation value specified in the H code.

The tool compensation vector changes as the offset value changes or movement is made on a rotation axis. When the tool compensation vector changes, movement is made according to the change value along the X-axis, Y-axis, and Z-axis.

Format

- Tool axis direction tool length compensation

```
G43.1 Hn ;  
n : Offset number
```

- Tool axis direction tool length compensation cancellation

```
G49 ;
```

● **Machine configuration**

The compensation of the tool length of the tool axis direction can be used for the machine of the following compositions.

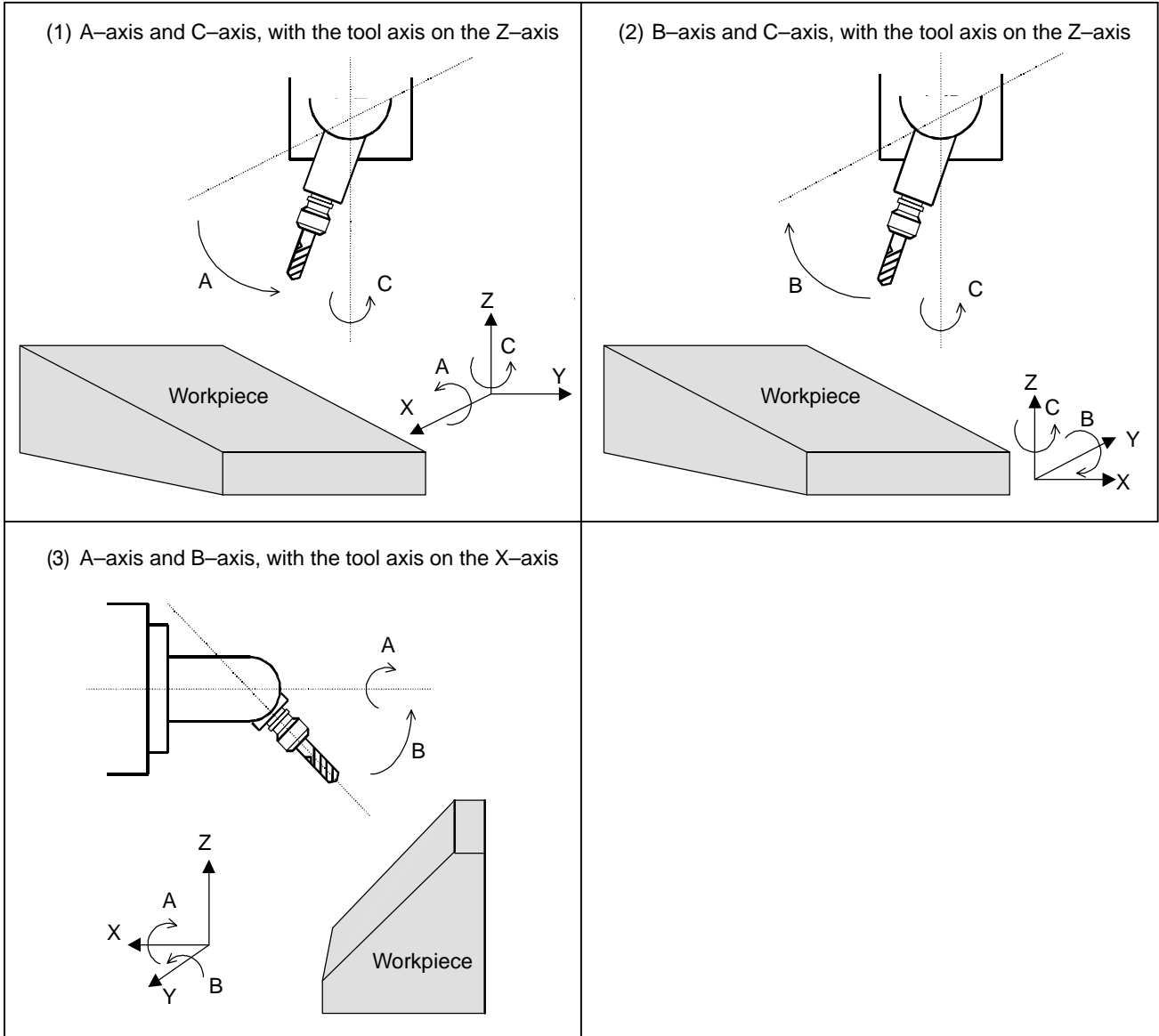

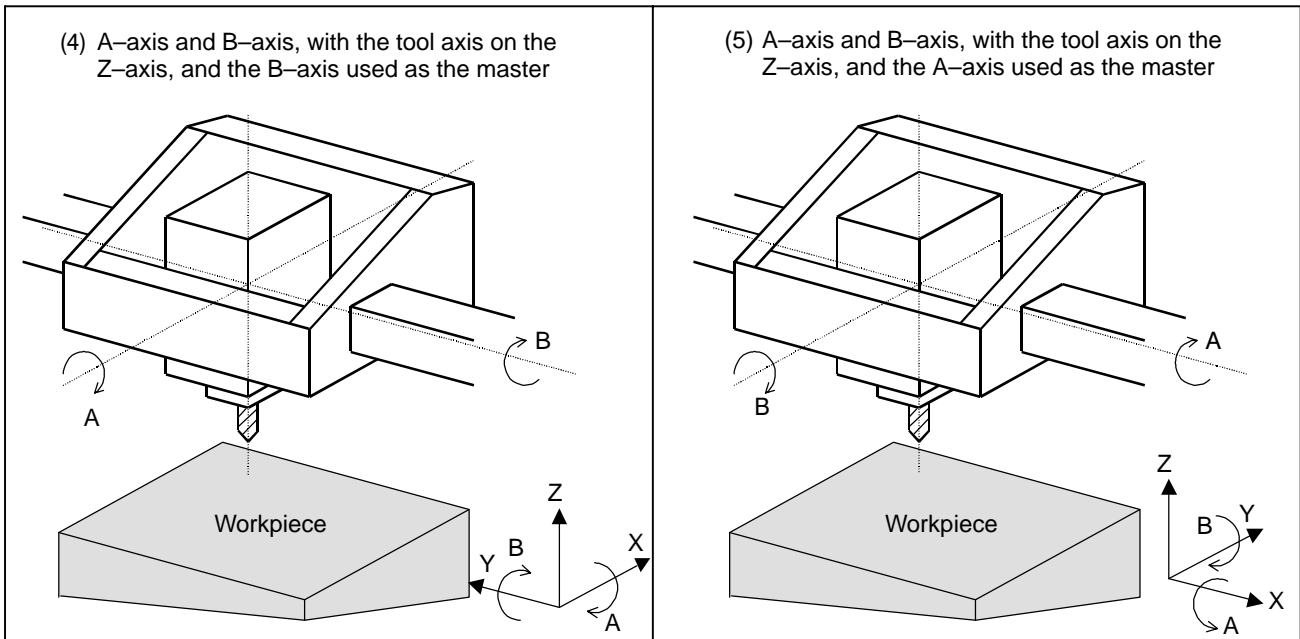

- **Parameter-based rotation angle specification**

A tool compensation vector is found from the coordinates on the rotation axes for controlling the tool axis direction. However, the configuration of some machines is such that the tool axis is inclined using a fixed attachment. In such a case, the rotation angles of the rotation axes can be set using parameters.

- **Tool holder offset**

The machine-specific length from the rotation center of the tool rotation axes (A- and B-axes, A- and C-axes, and B- and C-axes) to the tool mounting position is referred to as the tool holder offset. Unlike a tool length offset value, a tool holder offset value is set in parameter No. 7648. When tool axis direction tool length compensation is applied, the sum of the tool holder offset and tool length offset is handled as a tool length for compensation calculation.

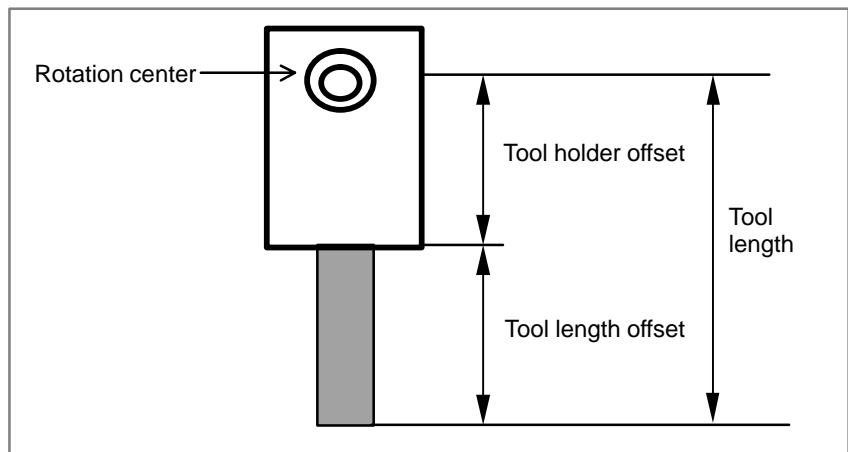

- **Rotation axis origin compensation and rotation axis offset**

This function compensates for a slight shift of the rotation axis origin caused, for example, by thermal displacement. Set offsets relative to the rotation angles of the rotation axes in parameter.

14.15 THREE-DIMENSIONAL CUTTER COMPENSATION

The three-dimensional cutter compensation function is used with machines that can control the direction of tool axis movement by using rotation axes (such as the B- and C-axes). This function performs cutter compensation by calculating a tool vector from the positions of the rotation axes, then calculating a compensation vector in a plane (compensation plane) that is perpendicular to the tool vector.

There are two types of cutter compensation: Tool side compensation and leading edge compensation. Which is used depends on the type of machining.

14.15.1 Tool Side Compensation

Tool side compensation is a type of cutter compensation that performs three-dimensional compensation on a plane (compensation plane) perpendicular to a tool direction vector.

Format

- Tool side compensation (left side)

G41.2 X_Y_Z_D_ ;

When type C is selected for the startup operation or cancel operation, the move command such as X_Y_Z_ must not be specified in the G41.2 block.

- Tool side compensation (right side)

G42.2 X_Y_Z_D_ ;

When type C is selected for the startup operation or cancel operation, the move command such as X_Y_Z_ must not be specified in the G42.2 block.

- Tool side compensation cancellation

G40 X_Y_Z_ ;

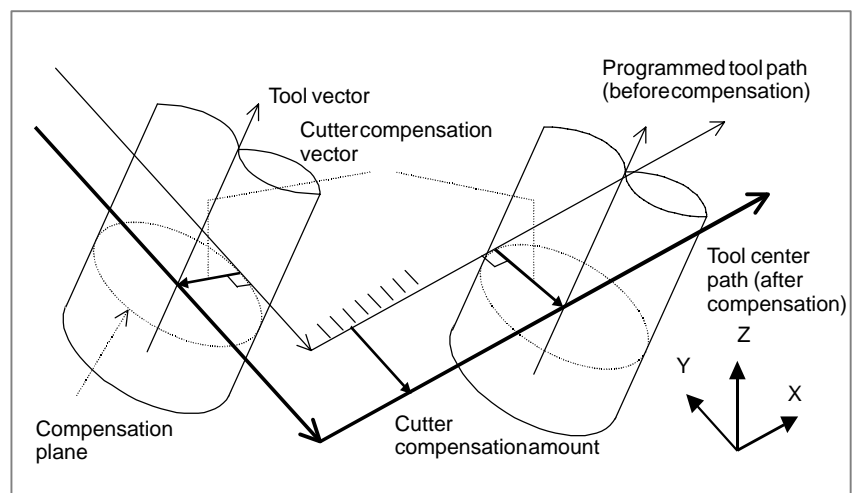

14.15.2 Leading Edge Offset

Leading edge offset is a type of cutter compensation that is used when a workpiece is machined with the edge of a tool. A tool is automatically shifted by a specified cutter compensation value on the line where a plane formed by a tool direction vector and tool movement direction intersects a plane perpendicular to the tool axis direction.

Format

- Leading edge offset

G41.3 D_ ;

- Leading edge offset cancellation

G40 ;

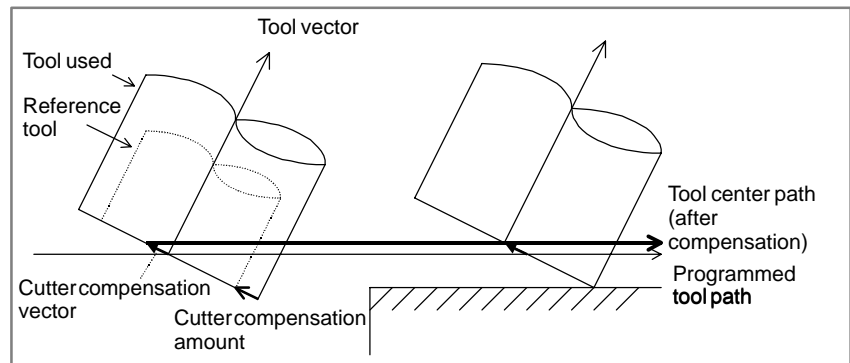

14.16 TOOL CENTER POINT CONTROL

On a five-axis machine having two rotation axes that turn a tool, tool length compensation can be performed momentarily even in the middle of a block.

Tool length compensation is classified into two types according to the programming method. In the explanation of this function, the two rotation axes are assumed to be the B- and C-axes.

(1) Type 1

The rotation axis position (B, C) is specified.

The CNC applies tool length compensation equal to the compensation amount along the tool axis whose orientation is calculated from the specified rotation axis position. This means that compensation is performed by moving the three linear axes.

(2) Type 2

The tool axis orientation (I, J, K) is specified.

The CNC controls the two rotation axes so that the tool is oriented as specified, and performs tool length compensation along the tool axis by the compensation amount. This means that compensation is performed by moving the two rotation axes and three linear axes.

Tool center point control (type 1) differs from tool length compensation along the tool axis as shown below:

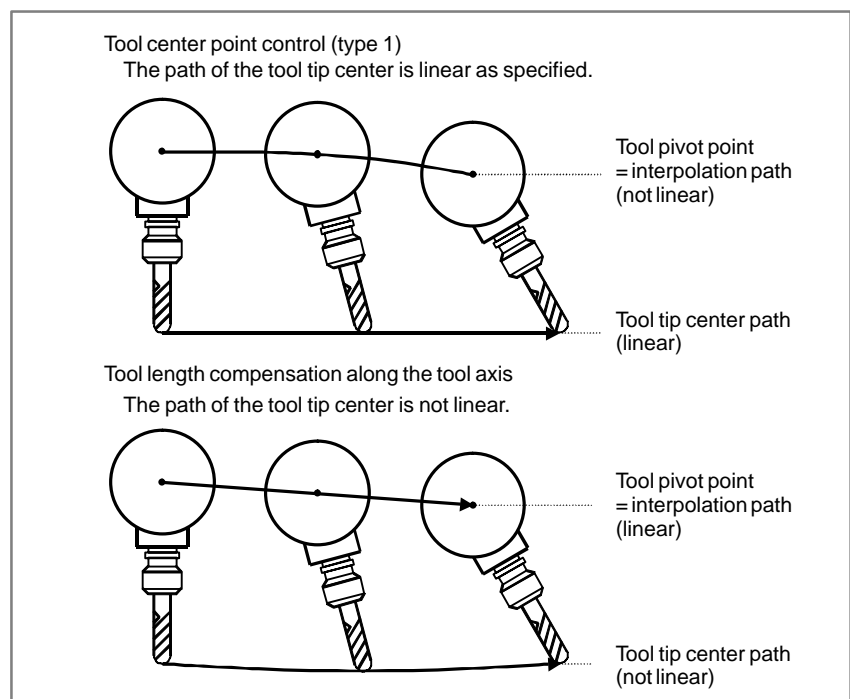

Fig. 14.16 Difference between tool center point control and tool length compensation along the tool axis

NOTE

The length from the tool tip to tool pivot point must equal the sum of the tool length compensation amount and tool holder offset value.

Format

- Specifying tool center point control (type 1)

G43.4 H_ ;
H : Offset number

- Specifying tool center point control (type 2)

G43.5 I_ J_ K_ H_ Q_ ;
I,J,K : Tool axis orientation
H : Offset number
Q : Tool inclination angle (degrees)

NOTE

- 1 When I, J, and K are all omitted from a block, the compensation vector in the previous block is used.
- 2 When any of I, J, and K is omitted, the omitted I, J, or K is assumed to be 0.
- 3 Movement of the rotation axes is controlled by shortcut control so that the amount of movement does not exceed 180.

- Canceling tool center point control

G49 ;

14.17 ROTARY TABLE DYNAMIC FIXTURE OFFSET

The rotary table dynamic fixture offset function saves the operator the trouble of re-setting the workpiece coordinate system when the rotary table rotates before cutting is started. With this function the operator simply sets the position of a workpiece placed at a certain position on the rotary table as a reference fixture offset. If the rotary table rotates, the system automatically obtains a current fixture offset from the angular displacement of the rotary table and creates a suitable workpiece coordinate system. After the reference fixture offset is set, the workpiece coordinate system is prepared dynamically, wherever the rotary table is located.

The zero point of the workpiece coordinate system is obtained by adding the fixture offset to the offset from the workpiece reference point.

Format

- Fixture offset command

G54.2 Pn ;
Pn : Reference fixture offset value number (1 to 8)
If n is set to 0, the fixture offset becomes invalid.

15

ACCURACY COMPENSATION FUNCTION



15.1 STORED PITCH ERROR COMPENSATION

The errors caused by machine position, as pitch error of the feed screw, can be compensated. This function is for better machining precision. As the offset data are stored in the memory as parameters, compensations of dogs and settings can be omitted. Offset intervals are set constant by parameters (per axis).

This function can perform compensation as described below.

- Compensation period: Constant period for each axis (parameter settings (for each axis))
- Compensation points: Total of 1,024 points
Optional distribution to each axis (parameter settings (for each axis))
- Amount of compensation: The following compensation pulse is output at each compensation point.

Compensation pulse = $(-7 \text{ to } +7) \times (\text{compensation magnification})$

Unit: Same as the detection unit

-7 to +7: Setting for each compensation point (setting within the range of -7 to +7)

Compensation magnification: 1 to 100 times

Constant magnification for each axis (parameter settings (for each axis))

15.2 BI-DIRECTIONAL PITCH ERROR COMPENSATION

In bi-directional pitch error compensation, different pitch error compensation amounts can be set for travel in the positive direction and that in the negative direction, so that pitch error compensation can be performed differently in the two directions, in contrast to stored pitch error compensation, which does not distinguish between the directions of travel. In addition, when the direction of travel is reversed, the compensation amount is automatically calculated from the pitch error compensation data to perform compensation in the same way as in backlash compensation. This reduces the difference between the paths in the positive and negative directions.

Expanded compensation points in bi-directional pitch error compensation

Bi-directional pitch error compensation allows use of 0 to 1023,3000 to 4023 as compensation points.

This function has expanded the compensation points to 0 to 2559,3000 to 5559.

15.3 INTERPOLATION TYPE PITCH ERROR COMPENSATION

Stored pitch error compensation outputs a pitch error compensation pulse for each pitch error compensation point at compensation point intervals. (See Fig. 15.3 (a).)

Interpolation type pitch error compensation outputs one to several pulses to indicate the amount of compensation at each error compensation point during each error compensation point period. (See Fig. 15.3 (b).)

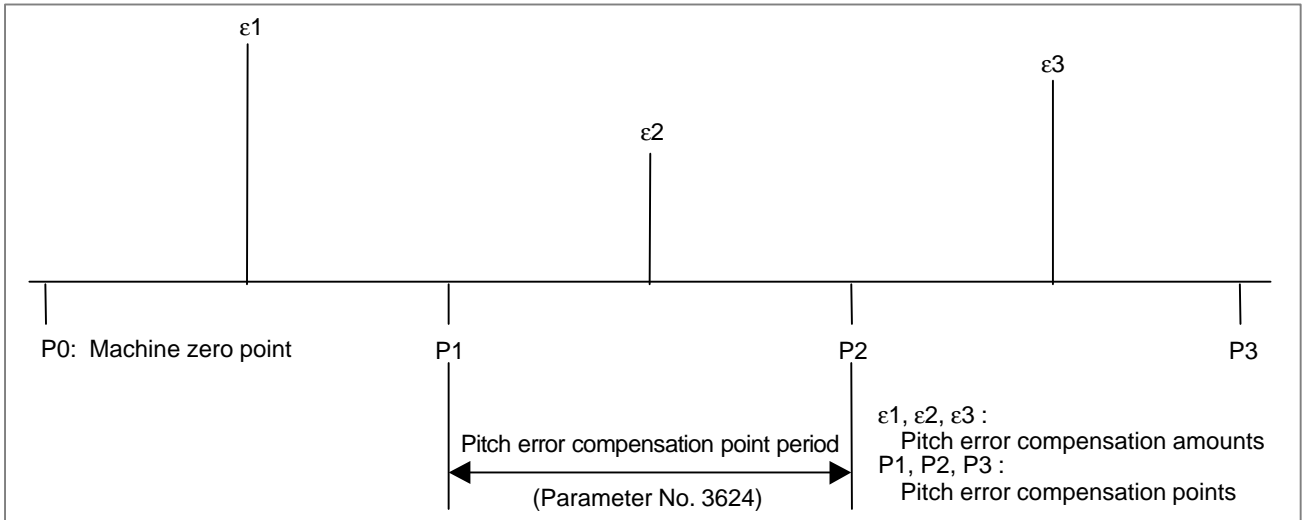

Fig. 15.3 (a) Method of stored pitch error compensation

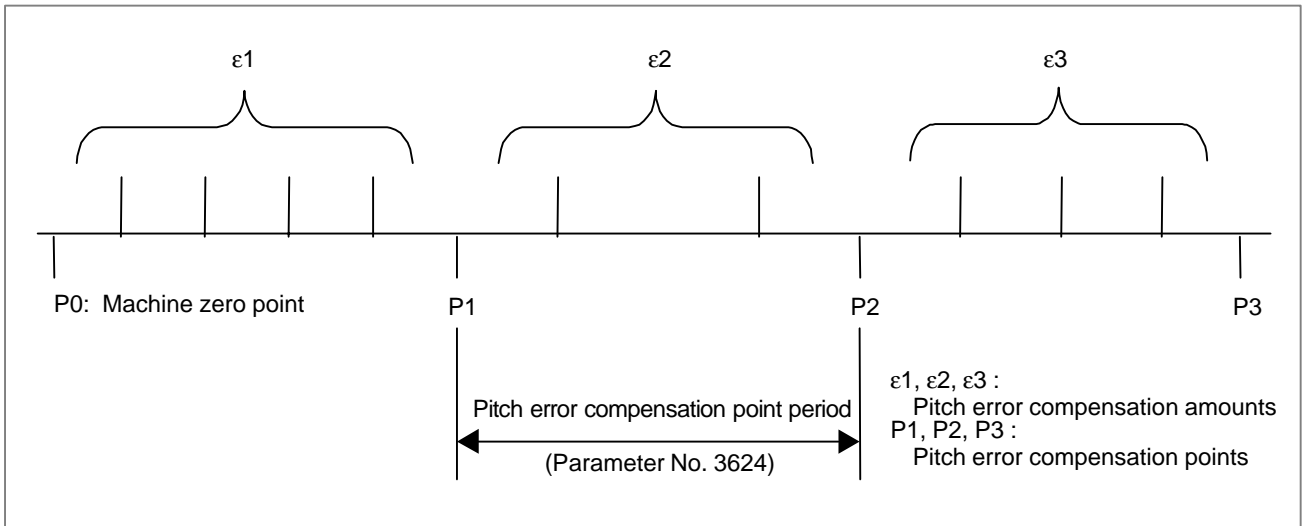
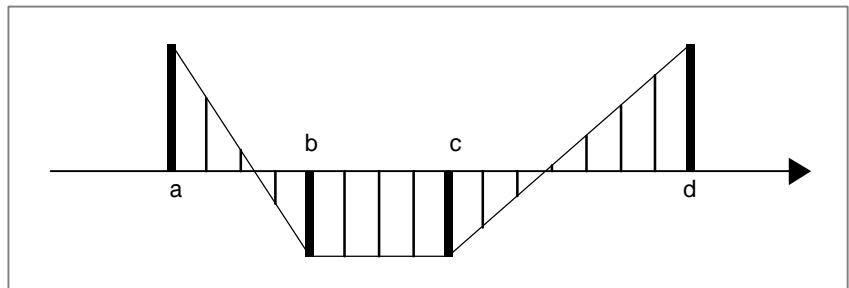

Fig. 15.3 (b) Method of interpolation type pitch error compensation

15.4 INCLINATION COMPENSATION

When a pitch error of a feed screw has a constant slope, you only need to select four representative points (a, b, c, d) from pitch error compensation points and set slope data for the four points; unlike pitch error compensation, you need not set compensation data for every compensation point. Then, compensation data at each compensation point is calculated automatically for compensation. (When movement along an axis for which slope compensation data is set is made, compensation is performed for that axis.) Pitch error compensation is required to use this function.



15.5 STRAIGHTNESS COMPENSATION

On a machine having a long stroke, machining precision may be reduced if the straightness of the axes is poor. The straightness compensation function compensates an axis in detection units while the tool is moving along another axis, thus improving machining precision. Moving the tool along an axis (the movement axis, specified with a parameter) compensates another axis (the compensation axis, specified with a parameter) within the range for pitch error compensation for the movement axis.

Example:

Pitch error compensation points along the movement axis

0 1 2 3 ... 60 61 ... 126 127

Machine coordinates along the movement axis

a b c d

α β γ ϵ

a, b, c, d : Compensation point numbers for the movement axis (same as the numbers of the pitch error compensation points)

$\alpha, \beta, \gamma, \epsilon$: Compensation value for each compensation point number (the amount of compensation performed for the compensation axis)

The compensation value applied to the compensation axis is $(\beta - \alpha)/(b - a)$ for the range between points a and b.

Explanations

Suppose a table having a ball thread in the Y-axis direction which is placed on a ball thread in the X-axis direction. When the ball thread in the X-axis direction has a constant slope because of deflection and so forth, the Y-axis that moves on the X-axis ball thread has an influence of the slope of the X-axis ball thread. As a result, the accuracy of the Y-axis lowers (Fig. 15.5 (a)).

When straightness compensation is used where the X-axis is set as the movement axis and the Y-axis set as the compensation axis, the Y-axis (the compensation axis) position is compensated according to the X-axis (the movement axis) position, which can improve the accuracy (Fig. 15.5 (b)).

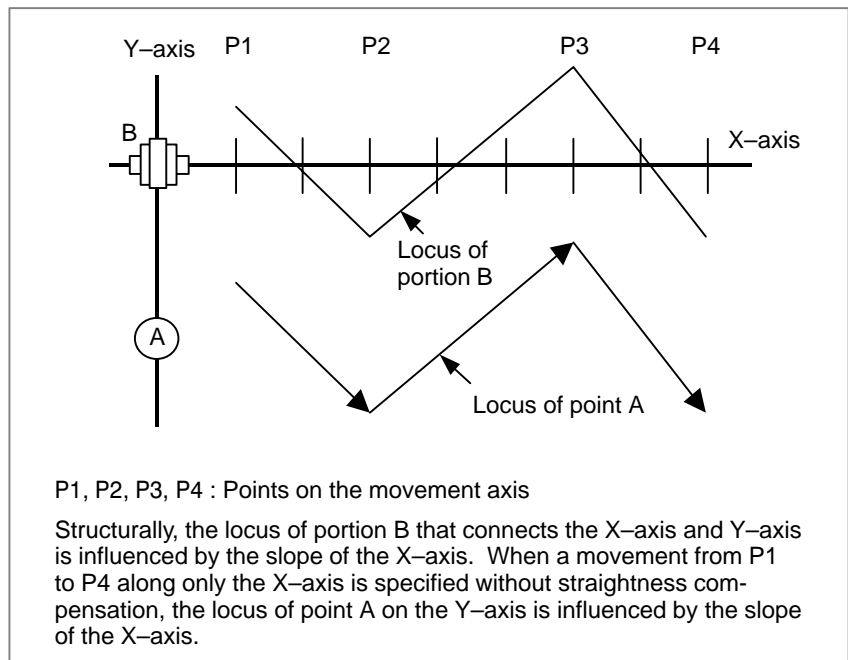

Fig. 15.5 (a)

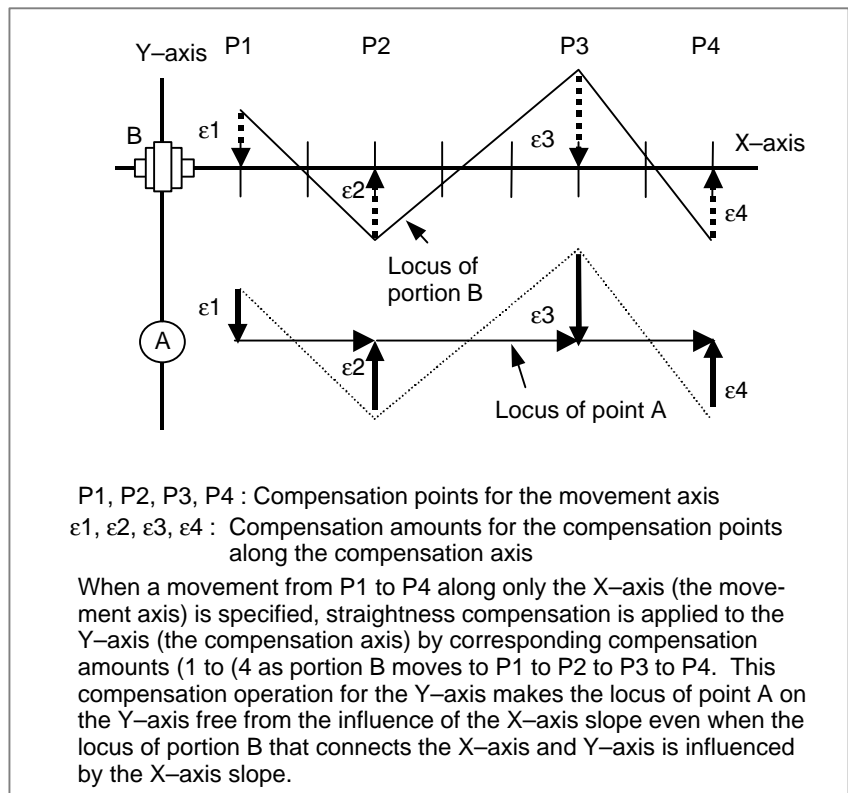

Fig. 15.5 (b)

NOTE

- 1 Straightness compensation is enabled once reference position return has been performed along the movement and compensation axes.
- 2 When the optional straightness compensation function is used, the optional storage pitch error compensation function is required.
- 3 Straightness compensation data is added to the storage pitch error compensation data when output.
- 4 In straightness compensation, the movement axis itself cannot be set as the compensation axis. To apply such a form of compensation, use slope compensation.

15.6 A DIFFERENCE AMONG PITCH ERROR COMPENSATION, INCLINATION COMPENSATION, AND STRAIGHTNESS COMPENSATION

These compensation functions all perform compensation at each compensation point according to the machine position by dividing machine strokes by the parameter-set compensation interval. Inclination compensation and straightness compensation use the compensation interval and compensation point numbers of pitch error compensation but use different compensation amounts that are prepared separately for the inclination compensation function and straightness compensation function.

In **pitch error compensation**, a compensation amount is set for each compensation point in advance. At each compensation point, the corresponding compensation amount is output.

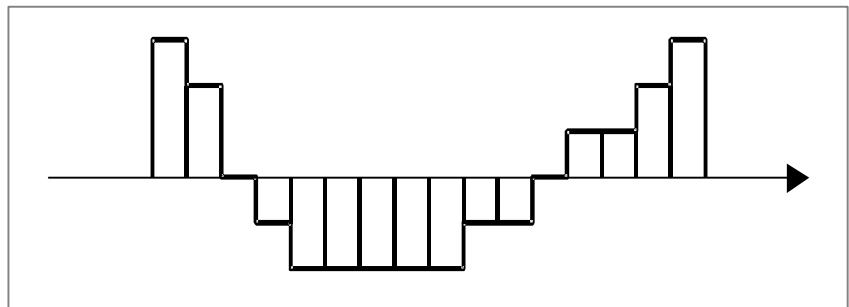

With bi-directional pitch error compensation, the compensation amount can be changed according to the axis move direction. In interpolation type pitch error compensation, compensation pulses are output even between compensation points, so smoother pitch error compensation is possible.

In **inclination compensation**, a compensation amount is not set for each compensation point; instead, compensation amounts are set for representative four points (a, b, c, d) (compensation points for inclination compensation) selected from the compensation points for pitch error compensation. At compensation points for pitch error compensation located between the compensation points for inclination compensation, the NC calculates and outputs the compensation amount according to the compensation amount for inclination compensation. Inclination compensation can be applied when pitch errors have a constant inclination.

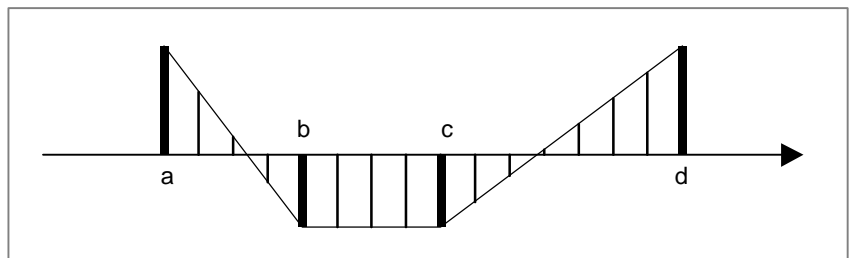

In **straightness compensation**, like inclination compensation, compensation amounts are set for representative four points (a, b, c, d) (compensation points for straightness compensation) selected from the compensation points for pitch error compensation. At compensation points for pitch error compensation located between the compensation points for straightness compensation, the NC calculates and outputs the compensation amount according to the compensation amount for straightness compensation.

The major difference from inclination compensation is that straightness compensation uses different axes as the movement axis and compensation axis. In inclination compensation, the movement axis is subjected to compensation. The relationship between the movement axis and compensation axis is defined by parameter setting (for example, the Y-axis is compensated according to the movement along the X-axis).

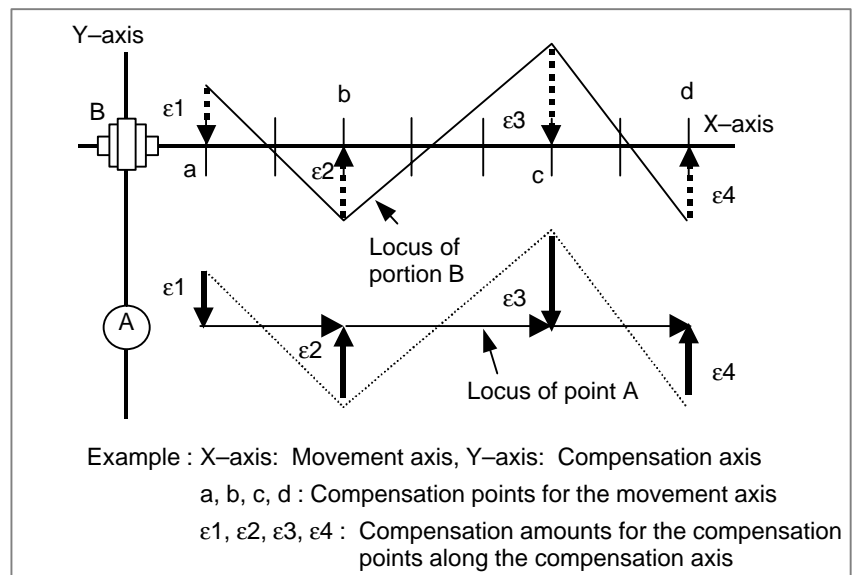

15.7 BACKLASH COMPENSATION

This function is used to compensate lost motions proper to the machine system. Offset amounts come in a range of 0 to ±9999 pulses per axis, and is set as parameters in detection unit.

15.8 BACKLASH COMPENSATION SPECIFIC TO RAPID TRAVERSE AND CUTTING FEED

Since different backlash compensation values can be used for cutting feed and rapid traverse, the machining precision is improved.

The following table shows backlash amounts according to the feedrate and movement direction. In the table, the backlash compensation amount for cutting feed is A, and that for rapid traverse is B. A and B are set in parameters.

	Cutting feed ↓ Cutting feed	Rapid traverse ↓ Rapid traverse	Rapid traverse ↓ Cutting feed	Cutting feed ↓ Rapid traverse
Movement in same direction	0	0	$\pm\alpha$	$\pm(-\alpha)$
Movement in opposite directions	$\pm A$	$\pm B$	$\pm(B+\alpha)$	$\pm(B+\alpha)$

*1) $\alpha = (A - B) / 2$

*2) Signs (+ and -) indicate directions.

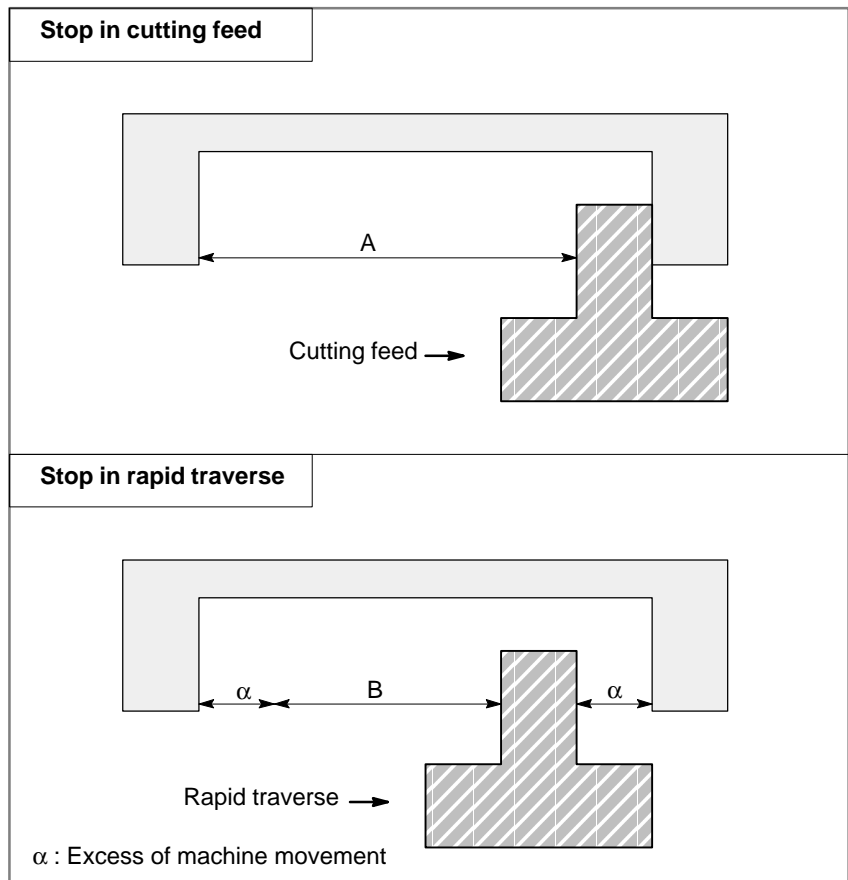

15.9 PROGRAMMABLE PARAMETER ENTRY (G10, G11)

Parameters and pitch errors data can be set by programs. therefore, following uses can be done example.

- Parameter setting such as pitch errors compensation data, etc. when the attachment is replaced.
- Parameters such as max. cutting speed and cutting feed time constant can be changed according to the machining conditions.

Format

```
G10 L50 ;  
N_ R_ ; Input of parameters except axis type  
N_ P_ R_ ; Input of axis type parameters  
:  
G11 ;
```

G10 L50 : Parameter input mode
G11 : Parameter input mode cancel
N_ : Parameter No. (or pitch error data No.+10000)
P_ : Axis No. (in the case of axis type parameter)
R_ : Parameter setting value (or pitch error data)

NOTE

Some parameters cannot be set.

15.10 INTERPOLATED STRAIGHTNESS COMPENSATION

128 straightness compensation points

The following two functions are available:

- <1> 128 straightness compensation points
- <2> Interpolated straightness compensation

In conventional straightness compensation, compensation data is set for four compensation points with parameters to obtain compensation data along an approximate straight line connecting the four points and perform compensation based on the data.

This function allows data for up to 128 equally spaced compensation points to be set in the same way as for ordinary pitch error compensation. By this function, fine compensation is also available for "straightness compensation."

This function also allows up to six combinations of movement and compensation axes for straightness compensation.

Interpolated straightness compensation

In conventional straightness compensation, for each interval between pitch error compensation points set by parameters, the amount of all straightness compensation at the compensation point is output and compensation is performed.

This function equally divides the amount of compensation for each interval between pitch error compensation points for compensation data set using 128 straightness compensation points and outputs it as a compensation pulse.

NOTE

To add the interpolated straightness compensation option, the stored pitch error compensation option is also required.

16 COORDINATE SYSTEM CONVERSION



16.1 COORDINATE SYSTEM ROTATION (G68, G69) – (M SERIES) (G68.1, G69.1) – (T SERIES)

Patterns specified by the program can be rotated. For example, by using this function, when the attached workpiece comes in a position which is somewhat rotated from the machine coordinates, the position can be compensated by the rotation instruction.

If a pattern is similar to that made by rotating a programmed figure, the program for the pattern can be created by calling the program for the figure as a sub program, and rotating the coordinates in the program. This function reduces the programming time and program length.

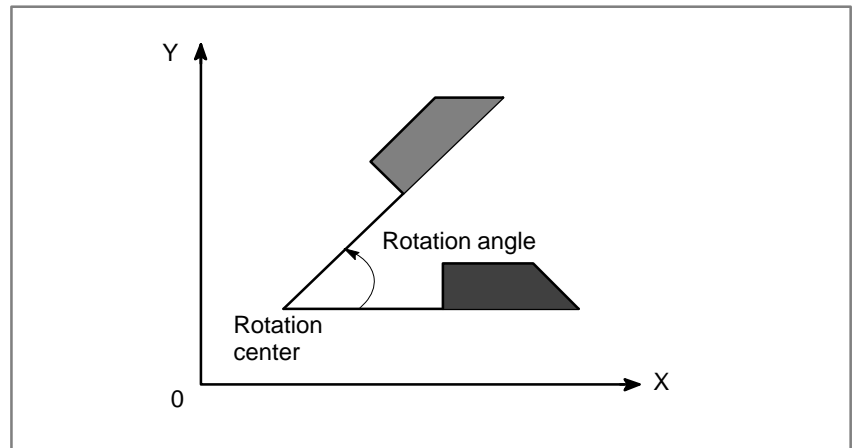

Format

M series	
$\left. \begin{array}{l} \mathbf{G17} \\ \mathbf{G18} \\ \mathbf{G19} \end{array} \right\}$	$\mathbf{G68} \alpha_ \beta_ \mathbf{R}_$; Coordinate system rotation start
$\left. \begin{array}{l} \vdots \\ \vdots \end{array} \right\}$	Coordinate system rotation mode (Coordinate system rotates.)
$\mathbf{G69}$;	Coordinate system rotation cancel
T series	
$\left. \begin{array}{l} \mathbf{G17} \\ \mathbf{G18} \\ \mathbf{G19} \end{array} \right\}$	$\mathbf{G68.1} \alpha_ \beta_ \mathbf{R}_$;
$\left. \begin{array}{l} \vdots \\ \vdots \end{array} \right\}$	Coordinate system rotation mode (Coordinate system rotates.)
$\mathbf{G69}$;	Coordinate system rotation cancel
α, β : Coordinate value of rotation center specify two axes from X, Y, Z axes of G17, G18, G19. (These are always absolute values.)	
R : Rotation (+ for the counterclockwise direction. Specified in absolute value. It can be also specified in incremental values according to the parameter setting.)	

By this command, commands thereafter are rotated in the angle commanded by R, with the point commanded by α , β as the rotation center. Rotation angle is commanded in 0.001 x units in a range of:

$$-360000 \leq R \leq 360000$$

The rotation plane is the plane selected (G17, G18, G19) when G68 (G68.1) was commanded.

G17, G18 and G19 may not be commanded in the same block as G68.

When α , β is omitted, the point where G68 (G68.1) was commanded becomes the rotation center.

G69; (M series), G69.1 ; (T series) Cancels the coordinate system rotation.

16.2 **M series** SCALING (G50, G51)

Scaling can be commanded to figures commanded in the machining programs.

Format

When each axis is scaling of the same magnification	
Format	Sign explanation
G51 X_ Y_ Z_ P_ ; Scaling start	X_Y_Z_ : Absolute command of center coordinate value of scaling P_ : Magnification of scaling
⋮ ⋮ } Scaling is effective. ⋮ } (Scaling mode)	
G50 ; Scaling cancellation	

By this command, scaling of the magnification specified by P is commanded with the point commanded by X, Y, Z as its center. G50 cancels to scaling mode.

G50 : Scaling mode cancel

G51 : Scaling mode command

Commandable magnification is as follows :

0.00001 - 9.99999 times or 0.001 - 999.999

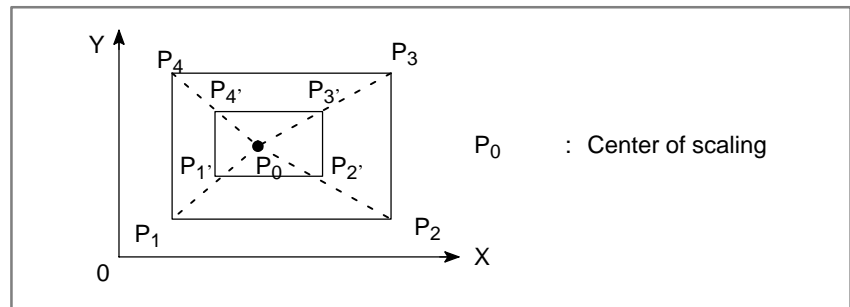

If P was not commanded, the magnification set by parameters is applied. When X, Y, Z are omitted, the point where G51 was commanded becomes the center of scaling.

Scaling cannot be done to offset amounts such as tool length compensation, cutter radius compensation, or tool offset.

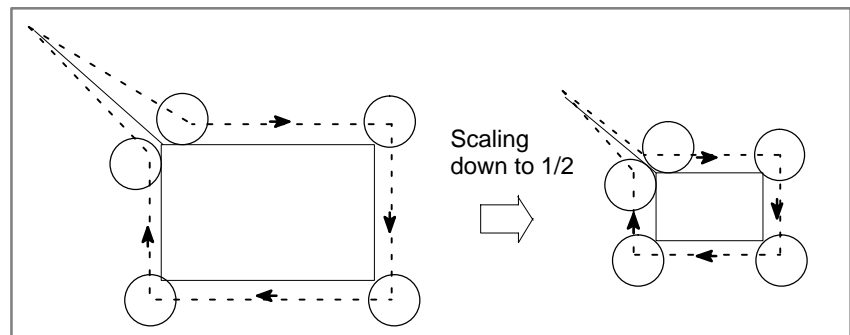

A scaling magnification can be set for each axis or for all axes in common. A parameter can specify whether it should be set for each axis or for all axes.

Format

Scaling of each axis (Mirror image)	
Format	Sign explanation
G51 X_ Y_ Z_ I_ J_ K_ ; Scaling start : : } Scaling is effective. : (Scaling mode) G50 ; Scaling cancellation	X_ Y_ Z_ : Absolute command of center coordinate value of scaling I_ J_ K_ : Magnification of scaling of X axis, Y axis, and Z axis (Unit 0.001 or 0.00001 is selected according to the parameter.) The magnification which can be instructed is as follows. ±0.00001–±9.99999 or ±0.001–±999.999

If magnifications I, J, or K are not specified, the magnification of each axis set by a parameter is used.

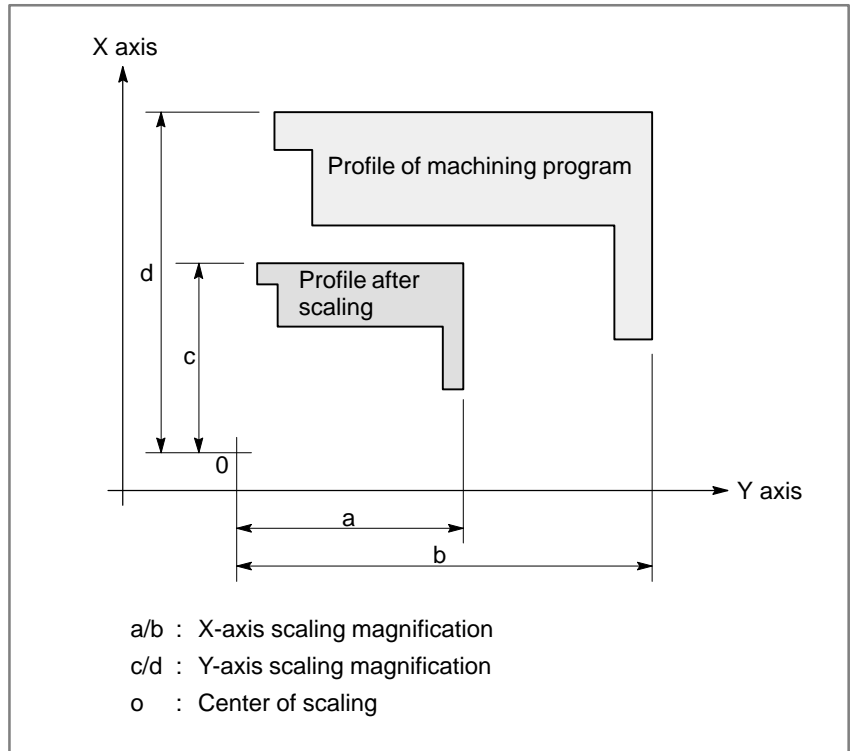

16.3 THREE- DIMENSIONAL COORDINATE CONVERSION (G68, G69)

M series

Coordinate conversion about an axis can be carried out if the center of rotation, direction of the axis of rotation, and angular displacement are specified. This function is very useful in three-dimensional machining by a die-sinking machine or similar machine. For example, if a program specifying machining on the XY plane is converted by the three-dimensional coordinate conversion function, the identical machining can be executed on a desired plane in three-dimensional space.

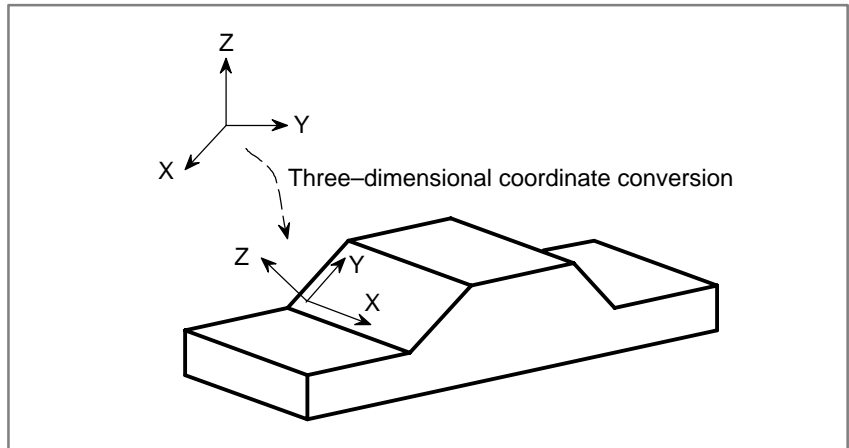

Format

G68	$X_{p\underline{x}_1}$	$Y_{p\underline{y}_1}$	$Z_{p\underline{z}_1}$	$I_{\underline{i}_1}$	$J_{\underline{j}_1}$	$K_{\underline{k}_1}$	$R_{\underline{\alpha}}$;	Starting
	⋮								} Three-dimensional coordinate conversion mode
G69								;	
	X_p, Y_p, Z_p	: Center of rotation (absolute coordinates) on the X, Y, and Z axis or parallel axes							
	I, J, K	: Direction of the axis of rotation							
	R	: Angular displacement							

Three-dimensional coordinate conversion can be applied up to two times.

N1 G68 $X_{p\underline{x}_1}$ $Y_{p\underline{y}_1}$ $Z_{p\underline{z}_1}$ $I_{\underline{i}_1}$ $J_{\underline{j}_1}$ $K_{\underline{k}_1}$ $R_{\underline{\alpha}}$;

N2 G68 $X_{p\underline{x}_2}$ $Y_{p\underline{y}_2}$ $Z_{p\underline{z}_2}$ $I_{\underline{i}_2}$ $J_{\underline{j}_2}$ $K_{\underline{k}_2}$ $R_{\underline{\beta}}$;

17 MEASUREMENT FUNCTIONS



17.1 SKIP FUNCTION (G31)

By commanding axis move after G31, linear interpolation can be commanded like in G01. If an external skip signal is input during this command, the remainder of this command is cancelled, and program skips to the next block.

G31 is a one-shot command and is valid for the commanded block only.

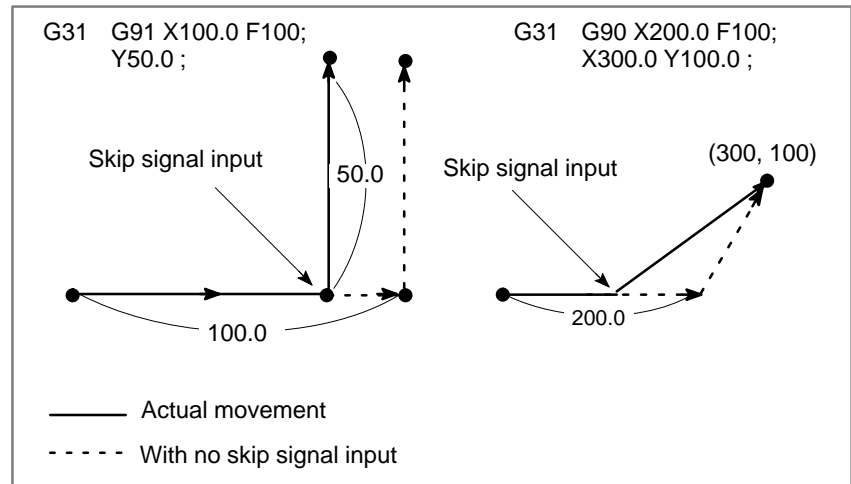

Coordinate value when skip signal is on, is stored in the system variables #5061 - #5068 of the customer macro, so this function can also be read with the customer macro function.

#506n : ntn axis skip signal position (n=1-8)

As the skip function can be used when move amount is not clear, this function can be used for:

- Constant feed in grinding machines
- Tool measurement with tactile sensor.

17.2 MULTI-STEP SKIP FUNCTION (G31 P1 - G31 P4)

n blocks with either of P1 to P4 following G31 commanded, the coordinate value where skip signals (4 types) were input is stored in the custom macro variables, and at the same time, the remaining movement of the block is skipped. It is also possible to skip the remaining dwell with the skip signal by parameter, in a block where: G04 is commanded (dwell).

Parameters decide which skip command or dwell command is valid to which of the four skip signals. The skip signal is not necessarily unique to a single skip command or dwell command; it is also possible to set a skip signal to multiple skip command or dwell commands.

17.3 HIGH-SPEED SKIP SIGNAL INPUT

Delay and error of skip signal input is 0–2 msec at the NC side (not considering those at the PMC side).

This high-speed skip signal input function keeps this value to 0.1 msec or less, thus allowing high precision measurement. This signal is connected directly to the NC; not via the PMC.

17.4 TORQUE LIMIT SKIP (G31 P99, G31 P98)

With the motor torque limited (for example, by a torque limit command, issued through the PMC window), a move command following G31 P99 (or G31 P98) can cause the same type of cutting feed as with G01 (linear interpolation).

Skip operation is performed when the motor torque reaches the limit, when the tool is pushed back for example, during cutting feed.

For details of how to use this function, refer to the manuals supplied by the machine tool builder.

Format

G31 P99 IP_ F_ ;

G31 P98 IP_ F_ ;

G31 : One-shot G code (G code effective only in the block in which it is issued)

P99 : Skip operation is performed when the motor torque reaches the limit or the skip signal is input.

P98 : Skip operation is performed only when the motor torque reaches the limit (regardless of the skip signal).

17.5 M series CONTINUOUS HIGH-SPEED SKIP FUNCTION (G31, P90)

The continuous high-speed skip function enables reading of absolute coordinates by using the high-speed skip signal. Once a high-speed skip signal has been input in a G31P90 block, absolute coordinates are read into custom macro variables #5061 to #5068. The input of a skip signal does not stop axial movement, thus enabling reading of the coordinates of two or more points.

The rising and falling edges of the high-speed skip signal can be used as a trigger, depending on the parameter setting.

Format

G31 P90 α _ F_

α _: Skip axis address and amount of travel
Only one axis can be specified. G31 is a one-shot G code.

17.6 TOOL LENGTH AUTOMATIC MEASUREMENT (G37)

M series

Difference between the coordinate value of tool when tool end has reached the measuring position and coordinate value of the measuring position is automatically measured, calculated, and added to the currently set tool offset amount by CNC system. The machine must be equipped with measuring devices, for example tactile sensor, so that a signal is sent when the tool end has reached the measuring position.

Measuring position coordinate value is commanded as follows:

Format

G37 α _ ;

α : The measuring position is commanded in by either X, Y, or Z.

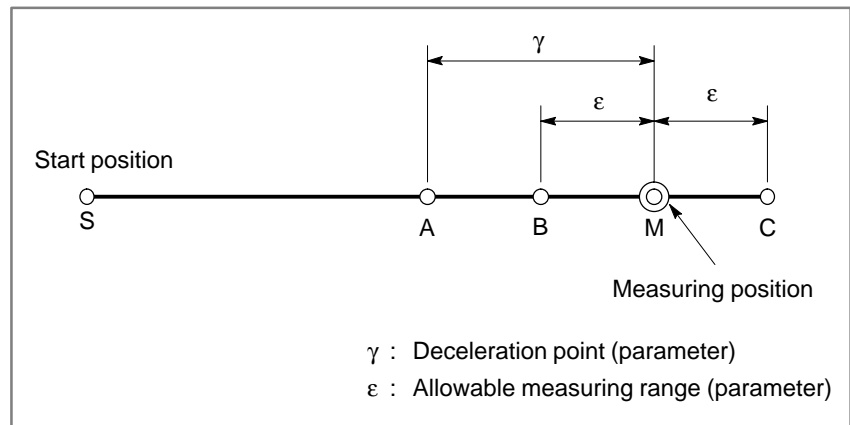

The tool is moved from the start position to the deceleration point A in rapid traverse, tool speed is decelerated to the measurement speed preset by parameter, and moved on till the measuring position reach signal is output. In case measuring position reach signal is not output in the allowable measuring range (from point B to C), and alarm arises.

(New offset amount) = (Old offset amount) + (Measuring position reach signal detected position) - (measuring position)

17.7 T series AUTOMATIC TOOL OFFSET (G37, G36)

Difference between the coordinate value of tool when tool end has reached the measuring position and coordinate value of the measuring position is automatically measured, calculated, and added to the currently set tool offset amount by CNC system. The machine must be equipped with measuring devices, for example tactile sensor, so that a signal is sent when the tool end has reached the measuring position.

Measuring position coordinate value is commanded as follows:

Format

G36 X_ ;
or
G37 Z_ ;

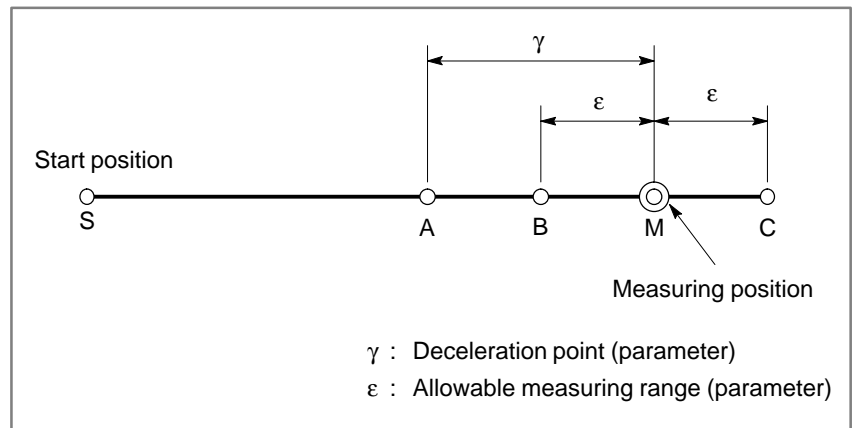

The tool is moved from the start position to the deceleration point A in rapid traverse, tool speed is decelerated to the measurement speed preset by parameter, and moved on till the measuring position reach signal is output. In case measuring position reach signal is not output in the allowable measuring range (from point B to C), and alarm arises.

(New offset amount) = (Old offset amount) + (Measuring position reach signal detected position) - (measuring position)

17.8 TOOL LENGTH MEASUREMENT

M series

The value displayed as a relative position can be set in the offset memory as an offset value by a soft key.

Call offset value display screen. Relative positions are also displayed on this screen. Reset the displayed relative position to zero. Set the tool for measurement at the same fixed point on the machine by hand. The relative position display at this point shows difference between the reference tool and the tool measured and the relative position display value is then set as offset amounts.

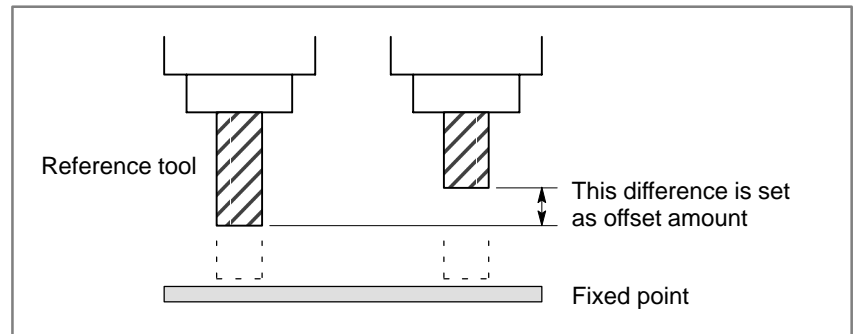

17.9 **T series** DIRECT INPUT OF TOOL COMPENSATION MEASURED VALUE/ DIRECT INPUT OF WORKPIECE COORDINATE SYSTEM SHIFT AMOUNT

This is a function of setting an offset value by key-inputting a workpiece diameter manually cut and measured from the MDI keyboard.

First the workpiece is cut in the longitudinal or in the cross direction manually. When a button on the machine operator's panel is pressed upon completion of the cutting, the workpiece coordinate value at that time is recorded. Then, withdraw the tool, stop the spindle, and measure the diameter if the cutting was on the longitudinal direction or distance from the standard face if it was on the facing. (The standard face is made as $Z = 0$.) When the measured value is entered into the offset number desired plus 100, NC inputs the difference between the input measured value and the coordinate value recorded in NC, as the offset value of the offset number.

The workpiece coordinate system can be shifted using the technique of directly inputting the measured value for offset. This technique is used when the coordinate system planned in the program does not match with the coordinate system set by the G92 command or by the automatic coordinate system setting.

The procedures are the same as those for direct input for offset, except a difference of using the standard tool.

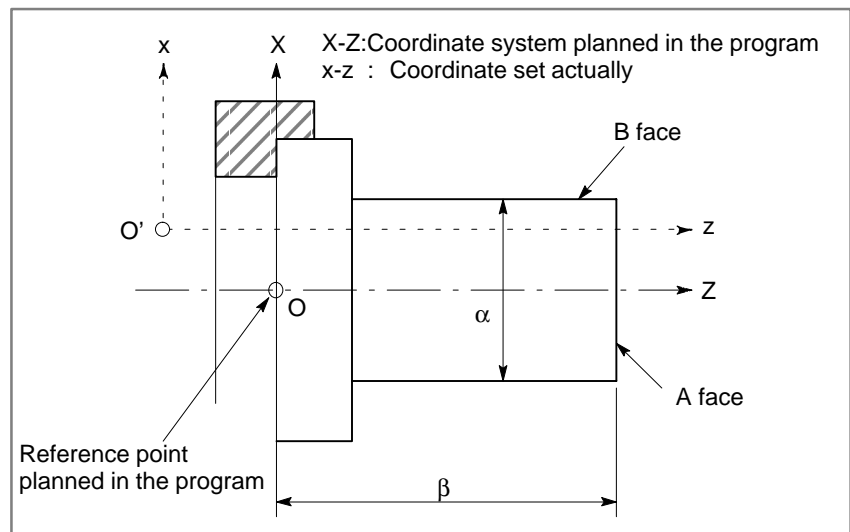

Cut A or B face and measure β or α . Direct input the measured value.

17.10 **T series** TOOL COMPENSATION VALUE MEASURED VALUE DIRECT INPUT B

By installing the touch sensor and by manually making the tool contact the touch sensor, it is possible to set the offset amount of that tool automatically in the tool offset amount memory. It is also possible to set the workpiece coordinate system shift amount automatically.

In addition, a tool setter function for one-turret two-spindle lathes is provided so that the tool compensation value measured value direct input B function can be used for both spindles of a one-turret two-spindle lathe.

Explanations

• Touch sensor

As the touch sensor detection mode, either four-contact input mode or single-contact input mode can be selected.

- 1) Four-contact input (when bit 3 (TS1) of parameter No. 5004 is set to 0)
The touch sensor has contact faces in two directions along each axis, and outputs four signals when a touch is detected. These signals are input to the CNC as tool compensation value writing signals (+MIT1, +MIT2, -MIT1, and -MIT2).

When any of these input signals is input, the CNC stops feed in the corresponding direction along the corresponding axis.

- 2) Single-contact input (when bit 3 (TS1) of parameter No. 5004 is set to 1)

The touch sensor outputs one signal when a touch by a single-contact input is detected. This signal is input to the CNC as the tool compensation value writing signal (+MIT1).

Then, the CNC determines the two directions along each axis automatically and stops feed in the corresponding direction along the corresponding axis.

Signal	Parameter	
	TS1=0	TS1=1
+MIT1	Contact the (+) contact face of the X-axis (Contact in the X+ direction)	The two directions along each axis is determined automatically.
-MIT1	Contact the (-) contact face of the X-axis (Contact in the X- direction)	Not used
+MIT2	Contact the (+) contact face of the Z-axis (Contact in the Z+ direction)	Not used
-MIT2	Contact the (-) contact face of the Z-axis (Contact in the Z- direction)	Not used

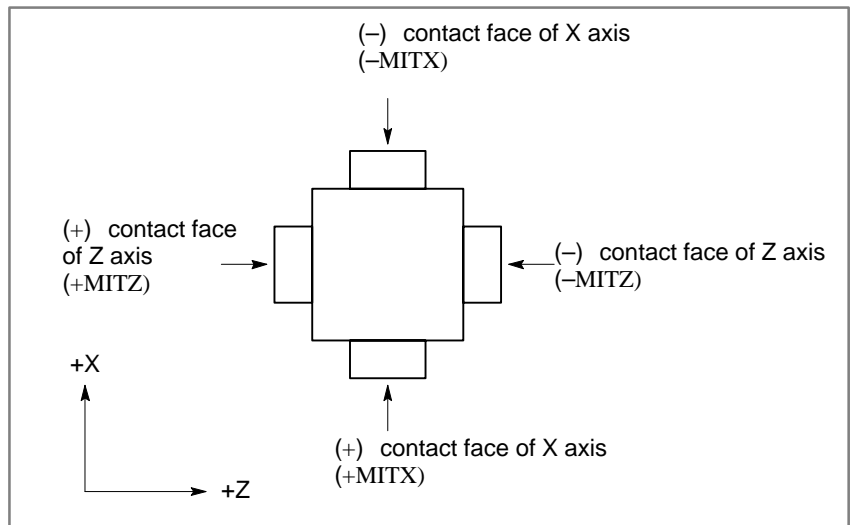

- **Setting method**

- **Setting of tool compensation value**

Previously set the distance from the measurement reference position (a particular point on the machine) to the measuring position (the touch sensor contact face) to the parameter as the reference value.

As the tool of which the offset amount is to be measured is selected and is positioned at the measuring position (contact the touch sensor), the contact detection signal (tool compensation value write signal) from the touch sensor is received, and the difference between the machine coordinate value at that time (= the distance from the measured tool nose tip position at the machine reference position (machine zero point) to the measuring position) and the reference value (parameter value) is set in the tool offset amount memory as the tool geometry offset amount of that tool. The corresponding tool wear offset amount becomes zero.

$$\left[\begin{array}{l} \text{Tool offset} \\ \text{amount to} \\ \text{be set} \end{array} \right] = \left[\begin{array}{l} \text{Machine coordi-} \\ \text{nate value when} \\ \text{tool compensa-} \\ \text{tion value write} \\ \text{signal turns "1"} \end{array} \right] + \left[\begin{array}{l} \text{Reference value} \\ \text{(value of parameter)} \\ \text{corresponding to} \\ \text{tool compensation} \\ \text{value write signal} \end{array} \right]$$

The tool offset amount to be set depends on how to determine the measurement reference position.

Supplement : When single-contact input (when bit 3 (TS1) of parameter No. 5004 is set to 1) is set for touch detection in the touch sensor

When receiving the touch detection signal (tool compensation value writing signal +MIT1) from the touch sensor, the CNC determines the two directions along each axis automatically according to the number of pulses stored for the movement along each axis that has been made until the input of the signal. (Set the number of interpolation cycles of stored pulses in parameter No. 5021 in advance.)

After determining the two directions along each axis automatically, the CNC applies axis interlock to the corresponding axis direction to stop feed operation, and the calculated tool compensation value is stored in tool compensation memory.

When stored pulses show various directions, when the servo power is shut down (the servo off state), or when no pulse is stored because no axis movement has taken place, the direction cannot be determined, so P/S alarm No. 5195 is generated.

Also when the tool moves along two axes (the X-axis and Z-axis), the P/S alarm is generated. So, the tool must be moved along just one axis.

If the P/S alarm is generated, the tool compensation value is not set, and the two axes and four directions are interlocked.

NOTE

- 1 Pulses used for automatic determination are stored while the tool compensation value writing mode select signal GOSQM <G039#7> is 1 in manual mode. These pulses are lost when:
 - a. A mode other than manual mode is set.
 - b. The tool compensation value writing mode select signal GOSOM <G039#7> is driven to 0.
 - c. The tool compensation value is set upon reception of the touch detection signal from the touch sensor, or P/S alarm No. 5195 is generated.
 - d. The servo off state is entered. In this case, the pulses stored for the axis for which the servo off state is entered are lost.
 - e. Axis movement is performed. In this case, pulses stored for the other axis along which no movement takes place are lost.
- 2 Axis interlock applied in the axis direction determined automatically and two-axis four-direction interlock applied due to a P/S alarm are released when a mode other than manual mode is set or when the tool compensation value writing mode select signal GOSQM <G039#7> is driven to 0. This type of interlock is not released by a reset operation.

□ Setting of workpiece coordinate system shift amount

The workpiece coordinate system shift amount along the Z axis is to be set as follows. When the tool touches the end face of the workpiece, the touch detection signal (workpiece coordinate system shift write signal) is output. This signal is used to set the workpiece coordinate system shift, calculated by subtracting the tool geometry compensation value (shift of coordinate system due to tool geometry compensation) from the current machine coordinate (distance between the end face of the workpiece and the tip of the measurement tool when it is at the machine reference position (machine zero point)). In this case the tool geometry offset amount corresponding to the tool must be programmed previously.

$$\left[\begin{array}{l} \text{Workpiece coordinate} \\ \text{system shift amount} \\ \text{along Z axis to be} \\ \text{set (EXOFSz)} \end{array} \right] = \left[\begin{array}{l} \text{Tool geometry offset} \\ \text{amount of Z axis of} \\ \text{corresponding tool} \\ \text{(OFSz)} \end{array} \right] + \left[\begin{array}{l} \text{Machine} \\ \text{coordinate value} \\ \text{of Z axis (Zt)} \end{array} \right]$$

By the above procedure the workpiece coordinate system with the workpiece edge (sensor contact point) being taken as the workpiece coordinate system zero point of the Z axis (the program zero point) is set when the tool is selected by the program command (T code).

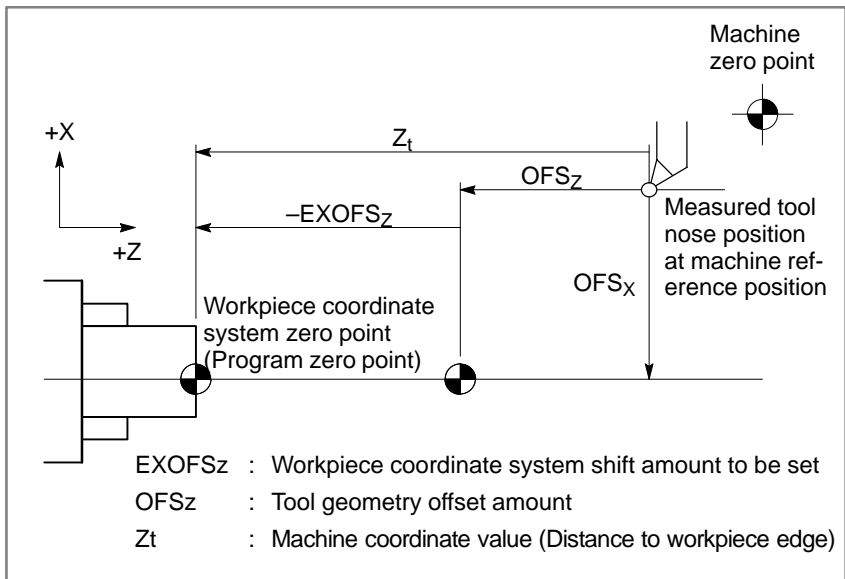

17.11 **T series** COUNT INPUT OF TOOL OFFSET VALUES

By manipulating soft keys, a position value displayed on the relative position display can be set to the offset memory.

Call offset value display screen on the screen. Relative positions are also displayed on this screen. Reset the displayed relative position to zero. Set the tool for measurement at the same fixed point on the machine by hand. The relative position display at this point shows difference between the reference tool and the tool measured and the relative position display value is then set as offset amounts.

17.12 DIRECT INPUT OF WORKPIECE ZERO POINT OFFSET VALUE MEASURED

By directly entering the measured deviation of the actual coordinate system from a programmed workpiece coordinate system, the workpiece zero point offset at the cursor is automatically set so that a command value matches the actual measurement.

17.13 **M series** TOOL LENGTH/ WORKPIECE ORIGIN MEASUREMENT B

To enable measurement of the tool length, the following functions are supported: automatic measurement of the tool length by using a program command (G37) (automatic tool length measurement, described in Section 17.6) and measurement of the tool length by manually moving the tool until it touches a reference position, such as the workpiece top surface (tool length measurement, described in Section 17.8). In addition to these functions, tool length/workpiece origin measurement B is supported to simplify the tool length measurement procedure, thus facilitating and reducing the time required for machining setup. This function also facilitates the measurement of the workpiece origin offsets.

This function allows the operator to specify T/M code commands or reference position return, by means of a manual numeric command, while the tool length offset measurement screen is displayed.

18

CUSTOM MACRO



18.1 CUSTOM MACRO

A function covering a group of instructions is stored in the memory like the sub program. The stored function is represented by one instruction and is executed by simply writing the represented instruction. The group of instructions registered is called the custom macro body, and the representative instruction, the custom macro instruction.

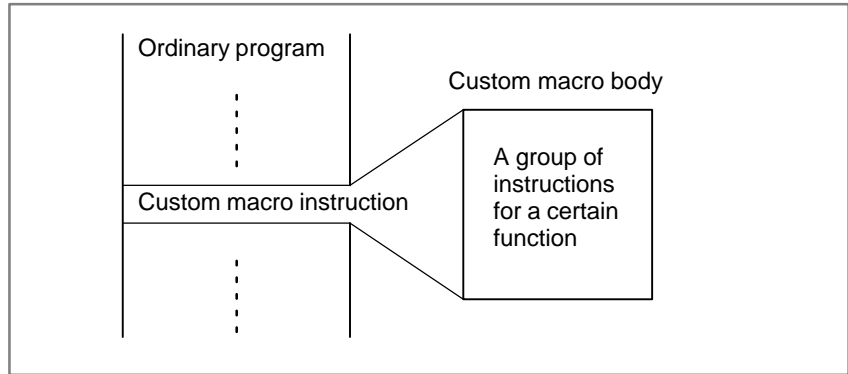

The programmer need not remember all the instructions in the custom macro body. He needs only to remember the representative, custom macro instruction.

The greatest feature in custom macro is that variables can be used in the custom macro body. Operation between the variables can be done, and actual values can be set in the variables by custom macro instructions.

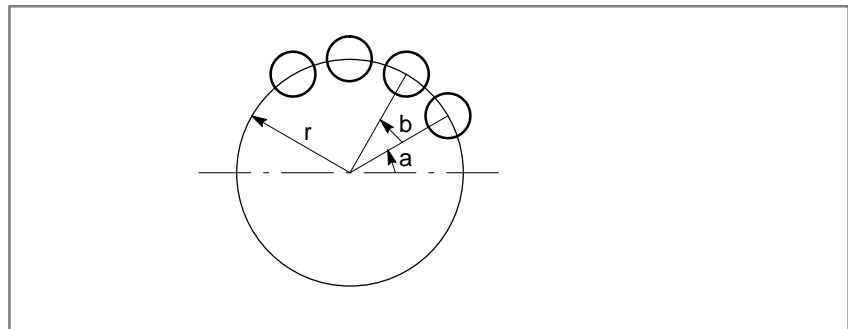
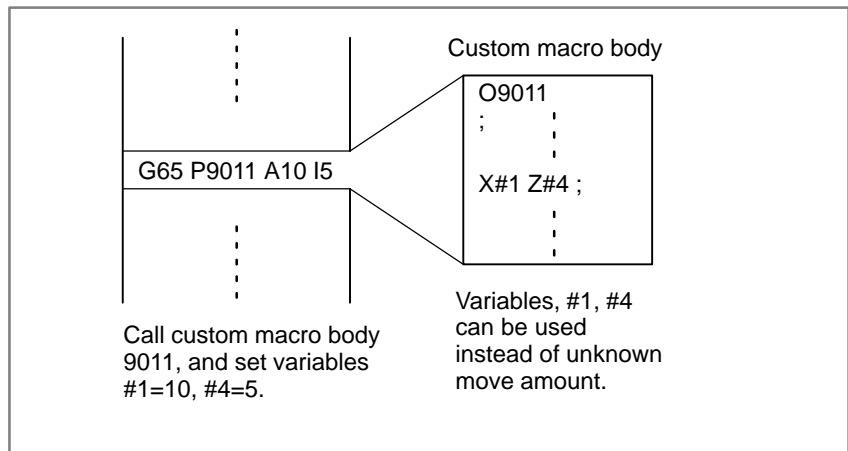

Bolt hole circle as shown above can be programmed easily. Program a custom macro body of a bolt hole circle; once the custom macro body is stored, operation can be performed as if the CNC itself has a bolt hole circle function. The programmer need only to remember the following command, and the bolt hole circle can be called any time.

Format

G65 Pp Rr Aa Bb Kk ;

p : Macro number of the bolt hole circle
 r : Radius
 a : Initial angle
 b : Angle between holes
 k : Number of holes

With this function, the CNC can be graded up by the user himself. Custom macro bodies may be offered to the users by the machine tool builder, but the users still can make custom macro himself.

The following functions can be used for programming the custom macro body.

Explanations

- **Use of Variable**

Variables: #1 (i=1, 2, 3,.....)

Quotation of variables: F#33 (#33: speed expressed by variables)

- **Operation between variables**

Various operation can be done between variables and constants.

The following operands, and functions can be used:

+ (sum), - (difference), * (product), / (quotient), OR (logical sum), XOR (exclusive logical sum), AND (logical product), SIN (sine), COS (cosine), TAN (tangent), ATAN (arc tangent), SQRT (square roots), ABS (absolute value), BIN (conversion from BCD to binary), BCD (conversion from binary to BCD), FIX (truncation below decimal point), FUP (raise fractions below decimal point), ROUND (round)

Example : #5 = SIN [#2 + #4] * 3.14 + #4] * ABS (#10)

- **Control command**

Program flow in the custom macro body is controlled by the following command.

If [<conditional expression>]GOTO n (n = sequence number)

When <conditional expression> is satisfied, the next execution is done from block with sequence number n.

When <conditional expression> is not satisfied, the next block is executed.

When the [<IF conditional expression>] is committed, it executes from block with n unconditionally.

The following <conditional expressions> are available:

#j EQ #k whether #j = #k

#j NE #k whether #j ≠ #k

#j GT #k whether #j > #k

#j LT #k whether #j < #k

#j GE #k whether #j ≥ #k

#j LE #k whether #j ≤ #k

IF[<conditional expression>]THEN

If the specified conditional expression is satisfied, a predetermined macro statement is executed. Only a single macro statement is executed.

WHILE (<conditional expression>) DO m (m = 1, 2, 3)

:

END m

While <conditional expression> is satisfied, blocks from DO m to END m is repeated.

When <conditional expression> is no more satisfied, it is executed from the block next to

END m block.

Example

```
#120 = 1 ;
WHILE [#120 LE 10] DO 1 ;
```

```
#120=#120+1 ;
```

```
END
```

} Repeated 10 times.

• **Format of custom macro body**

The format is the same as the sub program.

```
O Macro number ;
```

```
Custom macro body
```

```
M99 ;
```

• **Custom macro instruction**

Simple call

G65 P (macro number) L (times to repeat)

<argument assignment> ;

A value is set to a variable by <argument assignment>.

Write the actual value after the address.

Example A5.0E3.2M13.4

There is a regulation on which address (A - Z) corresponds to which variable number.

Modal call A

G66 P (macro number) L (times to repeat)

<argument assignment> ;

Each time a move command is executed, the specified custom macro body is called. This can be canceled by G67.

This function is useful when drilling cycles are programmed as custom macro bodies.

□ Macro call by G codes

The macro can also be called by the parameter-set G codes. Instead of commanding:

N_ G65 P○○○○ <argument assignment> ;

macro can be called just by commanding:

N_ Gxx <argument assignment> ;

G code for calling the macro, and macro program number **** to be called, are coupled together and set as parameter.

Maximum ten G codes from G01 to G9999 can be used for macro call (G00 cannot be used).

The G code macro call cannot be used in the macro which was called by a G code. It also cannot be used in sub programs called by sub program call with M codes or T codes.

□ Macro call by M code

Custom macros can be called by pre-determined M codes which are set by parameters.

The following command

N_ G65 P○○○○ <Argument assignment> ;

is equivalent to the following command:

N_ Mxx <Argument assignment> ;

The correspondence between M codes (Mxx) and program number (delta delta delta delta) of a macro shall be set by a parameter.

Signal MF and M code are not sent out the same as the subprogram call by M code.

Also when this M code is specified in a program called a macro calling G code or a subprogram calling M or T code, the M code is regarded as a normal M code.

Up to ten M codes from M01 to M99999999 can be used for custom macro calling M codes.

□ Sub program call by M code

An M code can be set by parameter to call a sub program. Instead of commanding:

N_ G_ X_ Y_ ... M98 P○○○○ ; ,

the same operation can be performed simply by commanding:

N_ G_ X_ Y_ ... Mxx ;

As for M98, M codes are not transmitted.

The M code XX for calling the sub program and the sub program number delta delta delta delta to be called are coupled together and set by parameter.

Maximum ten M codes from M01 to M99999999 can be used for macro call.

Arguments cannot be transmitted. It also cannot be commanded in the same block as the block with M98 command.

When these M codes are commanded in macro called by G code or in subprogram called by M code or T code, they are regarded as ordinary M codes.

Sub program call by T code

By setting parameter, sub program can be called by T codes. When commanded:

N_ G_ X_ Y_ ... Tt ; ,

the same operation is done as when commanded:

#149 = t;

N_ G_ X_ Y_ ... M98 P9000; .

The T type code t is stored as arguments of common variable #149. This command cannot be done in the same block with a sub program calling M code, or with M98 command. The T code is not output. When T code is commanded in macros called by G code, or in sub programs called by M codes or T codes, the T code is treated as ordinary T codes.

- **Types of variables**

Variables are divided into local variables, common variables, and system variables, according to their variable numbers. Each type has different use and nature.

 Local variables #1 – #33

Local variables are variables used locally in the macro. Accordingly, in case of multiples calls (calling macro B from macro A), the local variable used in macro A is never destroyed by being used in macro B.

 Common variables #100 – #149, #500 – #531

Compared with local variables used locally in a macro, common variables are common throughout the main program, each sub program called from the main program, and each macro. The common variable #1 used in a certain macro is the same as the common variable #i used in other macros. Therefore, a common variable #1 calculated in a macro can be used in any other macros.

Common variables #100 to #149 are cleared when power is turned off, but common variables #500 to #531 are not cleared after power is turned off.

NOTE

The range of common variables can be enlarged to #100 to #199, and #500 to #999 by the option. (See Section II-18.2.)

 System variables

A variable with a certain variable number has a certain value. If the variable number is changed, the certain value is also changed.

The certain value are the following:

- ◇ 16 points DI (for read only)
- ◇ 48 points DO (for output only)
- ◇ Tool offset amount, work zero point offset amount
- ◇ Position information (actual position, skip position, block end position, etc.)
- ◇ Modal information (F code, G code for each group, etc.)
- ◇ Alarm message (Set alarm number and alarm message, and the CNC is set in an alarm status. The alarm number and message is displayed.)

- ◇ A date (year, month, day) and time (hour, minute, second) are indicated.
- ◇ Clock (Time can be known. A time can also be preset.)
- ◇ Single block stop, Miscellaneous function end wait hold
- ◇ Feed hold, Feed rate override, Exact stop inhibition
- ◇ The number of machining parts is indicated. It can be preset.

- **External output commands**

Value of variables or characters can be output to external devices via the reader/puncher interface with custom macro command. Results in measurement is output using custom macro.

- **Limitations**

- Usable variables**
See "Types of variables".
- Usable variable values**
Maximum : $\pm 10^{47}$
Minimum : $\pm 10^{-29}$
- Constants usable in <expression>**
Maximum : ± 99999999
Minimum : ± 0.0000001
Decimal point allowed
- Arithmetic precision**
8-digit decimal number
- Macro call nesting**
Maximum 4 folds.
- Repeated ID numbers**
1 - 3
- () nesting**
Maximum 5 folds.
- Sub program call nesting**
8 folds (including macro call nesting)

18.2 INCREASED CUSTOM MACRO COMMON VARIABLES

The range of common variables can be enlarged to #100 to #199, and #500 to #999 by the option.

18.3 INTERRUPTION TYPE CUSTOM MACRO

When custom macro interruption signal is input during automatic operation, the block currently under execution is interrupted and the specified custom macro is activated. After execution of this custom macro, it returns to the interrupted block and continues execution of the remaining commands.

```
:  
M96P_ ;  
: When custom macro interruption signal is input between M96 block  
and M97 block, custom macro specified by P is activated.  
M97;  
:
```

This function enables implementation of an application of detecting a broken tool, entering a custom macro interrupt signal, executing a tool change cycle using the custom macro, and then restarting machining after the tool change.

18.4 PATTERN DATA INPUT

With this function, custom macro interruption signal can be input on detection of tool break, tool change cycle can be executed by custom macro, and machining is continued.

This function simplifies program creation for CNC machining. Instead of programming in the NC format, the program can be created by selecting a menu and entering data according to the menu displayed on the CRT screen. A menu is provided for each type of drilling such as boring and tapping. A programmer can select data necessary for actual machining from these menus. Machining data such as hole position and hole depth is also provided in menus. The programmer can create a program simply by entering data from the menus.

This function is basically executed by the custom macro created by a machine tool builder. What menus and machining data to prepare totally depends on a machine tool builder. Therefore, a machine tool builder can incorporate their own know-how into this function.

```

MENU:HOLE PATTERN                                O9505 N0001

  1. TAPPING
  2. DRILLING
  3. BORING
  4. POCKET
  5. BOLT HOLE
  6. LINEANGLE
  7. GRID
  8. PECK
  9.
 10.

>_
EDIT **** * 15:56:32 S 0 T0000
[ MACRO ] [ MENU ] [ OPR ] [ ] [(OPRT) ]

```

Pattern menu display

↓ 5 is selected

```

VAR. : BOLT HOLE                                O9505 N0001
NO.  NAME      DATA      COMMENT
500  TOOL      0.000
501  KIJUN X   0.000      *BOLT HOLE
502  KIJUN Y   0.000      CIRCLE*
503  RADIUS    0.000      SET PATTERN
504  S. ANGL   0.000      DATA TO VAR.
505  HOLES NO. 0.000      NO.500-505.
506
507
ACTUAL POSITION (RELATIVE)
X    0.000      Y    0.000
Z    0.000
>_
MDI **** * 15:56:32 S 0 T0000
[OFFSET ] [SETING ] [ ] [ ] [(OPRT) ]

```

Pattern data display

18.5 MACRO EXECUTER FUNCTION

There are two types of NC programs; those which, once created, are scarcely changed, and those which are changed for each machining type. The former are programs created by the custom macro, and the latter are machining programs. If programs of these types are executed simultaneously, a battery may run out or the custom macro may be destroyed by error operation.

Such problems can be solved by this function. The custom macro created by a machine tool builder is converted to an execute-form program, be cataloged in the Flash ROM module, and be executed.

Features

- Since the program is cataloged after converted to an execute-form program, the execution speed is high. The machining time is then reduced, and the precision is improved.
- Since the program is cataloged in Flash ROM, there is no problem of battery extinction or custom macro destruction by error operation. The reliability is improved.
- Since the cataloged program is not displayed on a program screen, the know-how of the machine tool builder is protected.
- Since the custom macro is cataloged in Flash ROM, the program edit memory can be used efficiently.
- The user can call the macro easily without knowing the cataloged program. A custom macro can be created and executed in the program edit memory as usual.
- An original screen can be created by using the graphic display or selecting screens by the soft key. The machine tool builder can extend the control function by using such functions as machining program creation and edit control, reader/punch interface control, and PMC data read/write functions.

NOTE

- 1 When the macro executor is attached, the order-made macro cannot be specified.
- 2 To use the macro executor function for graphics display, the option for the graphics function is required.

18.6 C LANGUAGE EXECUTER FUNCTION

As with the conversational macro function of macro executors/compilers, the C language executor function is used to customize screens and include unique operations. Application programs for display and operation can be created in standard C language, in the same way as programs are made for normal personal computers. A program compiled on a personal computer is transferred and stored in flash ROM in the CNC via a memory card. The program is read into memory upon activation of the CNC, and executed by the C language executor.

Features

- **Low-cost customization**

No special additional hardware is needed to run the C language executor and application programs (*). All available display units are supported. User applications can be included in the current CNC system.

NOTE

(*): The flash ROM/DRAM capacity may have to be increased.

- **Application development on a personal computer**

Application programs can be developed using an ordinary personal computer. Program development, from program creation and editing to compilation/linkage, can also be performed on a personal computer. And, to a certain extent, debugging is also possible on the personal computer.

- **High compatibility with C language application programs for personal computers**

Microsoft Corporation's C compiler (MS-C) is employed as the C language compiler. It is the de-facto standard C compiler for personal computers. The function library provided by the C language executor has excellent compatibility with the ANSI standards and MS-C. Therefore, application programs for ordinary personal computers can be transported to the CNC, except when they are dependent on particular hardware.

- **Integration of CNC software and applications**

An application program created by the machine tool builder is executed as one task of the CNC software. The application program can display its own screens in place of existing CNC screens. In addition, the application program can read and write CNC system data via libraries provided by the C language executor. This enables operation of the application program to be integrated with CNC software.

- **Using the C language executor with the macro executor**

The C language executor can be used with the macro executor. Not only executable macros, but also conversational macros can be used together. The screen display portion of a macro program already created by the machine tool builder can be replaced with a program coded in C. This can prevent existing software resources from becoming useless.

18.7 EMBEDDED MACROS

Macro programs created by the machine tool builder are stored in FROM. The macro programs stored in FROM are loaded into DRAM at power-up so that they can be called from CNC programs stored in ordinary part program storage (SRAM). These macro programs can be edited in the same way as ordinary CNC programs. An edited macro program can be stored in FROM.

An arbitrary password can be used to disable macro program editing. This function stores the machine tool builder's macro programs in an area separate from part program memory, so the machine tool builder can create macro programs without reducing the user program capacity. (Macro programs as large as 225-m paper tape storage size can be stored.) In addition, this function stores macro programs in FROM, so they cannot be erased easily by mistake.

Explanations

- **Program number**

The BOOT system allows I/O of embedded macro file INMC from FROM to a memory card.

Embedded macro program numbers are determined by setting the beginning program number in parameter No. 12011 and the end program number in parameter No. 12012. Program numbers beyond this range are assigned to user programs stored in part program storage.

- **Editing embedded macro programs**

Embedded macro programs can be edited in the same way as programs stored in part program storage. After edited, a macro program can be written (stored) into FROM to make the program available when the power is turned on again.

Edited macro programs can be input/output to external devices through an interface such as the reader/punch interface.

- **Write (storage) from DRAM to FROM**

Embedded macro programs in DRAM can be written into FROM. Macro programs in DRAM are stored in FROM at a time under the file name INMC.

- **Embedded macro key (keyword, password)**

When a new FROM file INMC for embedded macros is created, a password can be given to the INMC file by setting a value from -99999999 to 99999999 (the password) in parameter No. 12013 and storing (saving) a macro program in FROM. If the password is set to 0, no password is assumed, and the file is left unlocked.

To unlock the file, enter the password in parameter No. 12013.

When the file is in the unlocked state, an embedded macro program can be stored in FROM. The items 1 to 5 listed below follow parameter settings in the CNC.

To lock the file, enter a non-password value in parameter No. 12013. When the file is locked, no embedded macro program can be stored. The items 1 to 5 listed below follow the parameter-set data stored in FROM.

1. Embedded macro program overwrite enabled/disabled (bit 0 of parameter No. 12001)
2. Embedded macro program reference and editing enabled/disabled (parameter No. 12010)
3. Embedded macro program number (parameter Nos. 12011 and 12012)
4. Embedded macro series and edition (parameter Nos. 12015 and 12016)
5. Embedded macro G codes and corresponding program numbers (parameter Nos. 12020 to 12049)

-
- **Read from FROM to DRAM (loading)** The INMC file in FROM is loaded into the embedded macro DRAM area at power-up.
 - **I/O from FROM** The BOOT system allows I/O of embedded macro file INMC from FROM to a memory card.
 - **Embedded-macro call** A G code is used to call an embedded macro program. The relationships between G codes and the numbers of called embedded macro programs are set in parameters. Up to 10 pairs can be set. Embedded macro programs can also be called using a macro call by G65 or G66 and a sub-program call by M98.
 - **Common variables #200 to #499** Common variables #200 to #499 can be used.
 - **Series and edition** Created embedded macro files can be managed with series and editions. The series and edition of the embedded macro file currently used are indicated to the right of "EMBED MCR" on the system configuration screen.

18.8 **M series** EMBEDDED MILLING MACRO

When this function is incorporated into the embedded macro function, four types of machining cycles (drilling, facing, side facing, and pocketing) can be used easily. For use of this function, the embedded macro, canned cycle, and custom macro B options are required.

NOTE

This function and the manual guide function cannot be specified at the same time. A function equivalent to this function is included in the manual guide.

18.9 **M series** MEASUREMENT CYCLE

When this function is incorporated into the embedded macro function, two types of measurement cycles (a calibration cycle and measurement cycle) can be used easily. The calibration cycle measures compensation data for a probe that is a measuring device, and the measurement cycle performs measurement by using this compensation data.

There are two types of measurement cycles as follows:

- Centering measurement cycle: Measures coordinates that are to be used as the reference position of the workpiece, and sets that data in the workpiece coordinate system.
- Internal measurement cycle: Measures the dimensions and coordinates of a machined workpiece and sets them in appropriate variables.

NOTE

This function and the manual guide function cannot be specified at the same time. A function equivalent to this function is included in the manual guide.

19

SERIES 15 TAPE FORMAT/SERIES 10/11 TAPE FORMAT



19.1 SERIES 15 TAPE FORMAT

The programs for the following functions can be created in the Series 10/11 tape format, and be executed by the setting parameter, using the memory.

- Equal lead threading (G33) (T series): (G32 for G-code system A)
- Sub program calling (M98)
- Canned cycles (G77, G78, G79) (T series):
(G90, G92, G94 for G-code system A)
- Multiple repetitive canned cycles (G71 to G76) (T series)
- Canned cycles for drilling (G80 to G85) (T series)
- Canned cycles (G73, G74, G76, G80 to G89) (M series)

NOTE

Addresses and range of values to be specified the Series 16/18 format restrictions are placed on the range of specifiable values of the basic address. Specifying a value outside the Series 16/18 format range causes a P/S alarm. The restrictions are placed also on some addresses.

19.2 SERIES-10/11 TAPE FORMAT

Memory operation of a program created for the following function in the Series 10/11 tape format can be performed based on the setting parameter.

- Equal-lead threading (G33) (T series) ... (G32 with G code system A)
- Subprogram call (M98)
- Canned cycle (G77, G78, G79) (T series) ... (G90, G92, and G94 with G code system A)
- Multiple repetitive canned cycle (G71 to G76) (T series)
- Canned cycle for drilling (G80 to G85) (T series)
- Canned cycle (G73, G74, G76, G80 to G89) (M series)

NOTE

Address and value specification range

The restrictions imposed on the Series 21 format are also imposed on the value specification range for the basic addresses. When a specified value exceeds the range of the Series 21 format, a P/S alarm is issued. The use of addresses may be restricted in some cases.

20

FUNCTIONS FOR HIGH SPEED CUTTING



20.1 HIGH-SPEED CYCLE MACHINING (ONLY AT 1-PATH CONTROL)

20.1.1 High-speed Cycle Machining (only at one-path)

This function converts the profile to be machined into data for high-speed pulse distribution, using the macro compiler or macro executor. It then calls and executes the data with the CNC command (G05) as a machining cycle.

Up to six axes can be commanded. (Up to six axes can be controlled simultaneously.)

The following command calls and executes the high-speed cycle machining data specified by the macro compiler or micro executor.

Format

G05 P10000 L000 ;

P10001 to P10999 : Starting number of the machining cycle to be called

L1 to L999 : Number of machining cycle repeats (The default value is L1.)

Up to 999-cycle data can be created. Address P specifies the cycle for machining. Two or more cycles can be called and executed successively according to the connection information (in the header). Address L specifies the number of times that the machining cycle is repeated. The number of repeats (in the header) can be specified for each cycle.

The following example explains the cycle connection and number of repeats.

Example)

G05 P10001 L2 is specified for the following cycles:

Cycle 1, connection 2, number of repeats 1

Cycle 2, connection 3, number of repeats 3

Cycle 3, connection 0, number of repeats 1

The cycles of 1,2,2,2,3,1,2,2,2,3 are executed successively.

20.1.2 High-Speed Cycle Machining Skip Function

This function cancels a repeated cycle operation of high-speed cycle machining and skips to the header information connected next. Note that, however, a skip does not take place at a halfway point of cycle operation.

Example)

G05P10001L3 ;

Cycle 1, connection information 2, number of repeats 1

Cycle 2, connection information 3, number of repeats 2

Cycle 3, connection information 4, number of repeats 3

Cycle 4, connection information 0, number of repeats 1

The cycles are executed as follows:

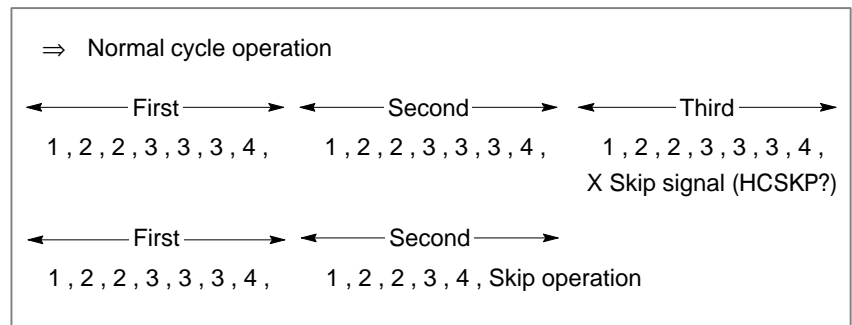

20.2 AUTOMATIC CORNER DECELERATION

This function automatically decelerates the tool at a corner according to the corner angle. It can prevent a large sag caused by acceleration/deceleration and servo delay on the junction of two blocks.

If the angle made by two consecutive blocks is less than the angle set by the parameter in the cutting mode (G64) (M series), the speed is automatically reduced at the end of the block. When the speed is reduced to the value set by the parameter or lower, movement of the next block starts.

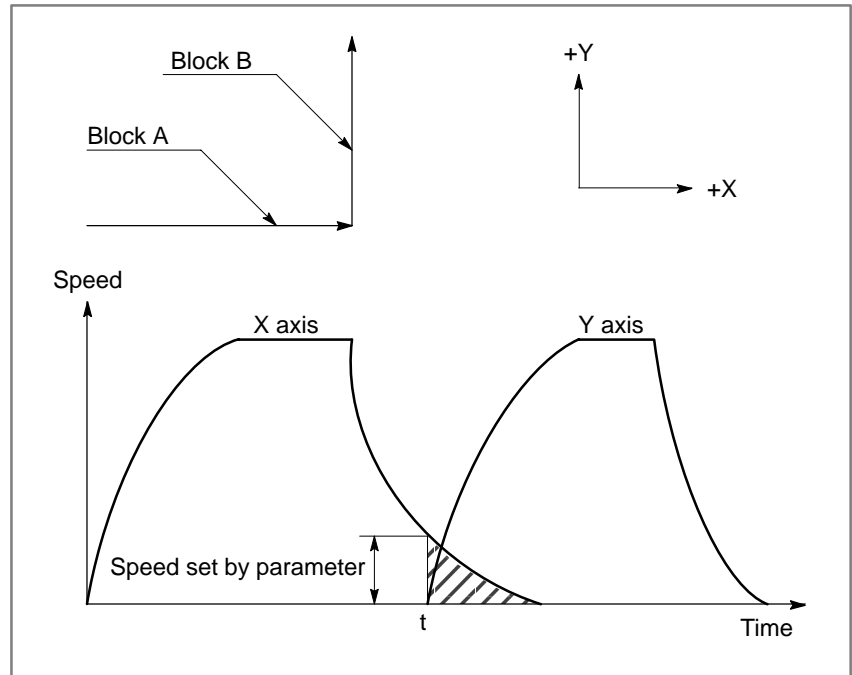

20.3 **M series**
FEEDRATE CLAMP
BY CIRCULAR
RADIUS

The machine is accelerated/decelerated automatically when the movement is started/stopped, so that the machine system should not be applied with any shock. When programming, therefore, no consideration needs to be made for acceleration/deceleration.

Especially when performing the high-speed arc cutting, however, the actual tool passage may bring about some error against the designated arc during circular interpolation due to this automatic acceleration/deceleration.

This error can approximately be given by the following formula;

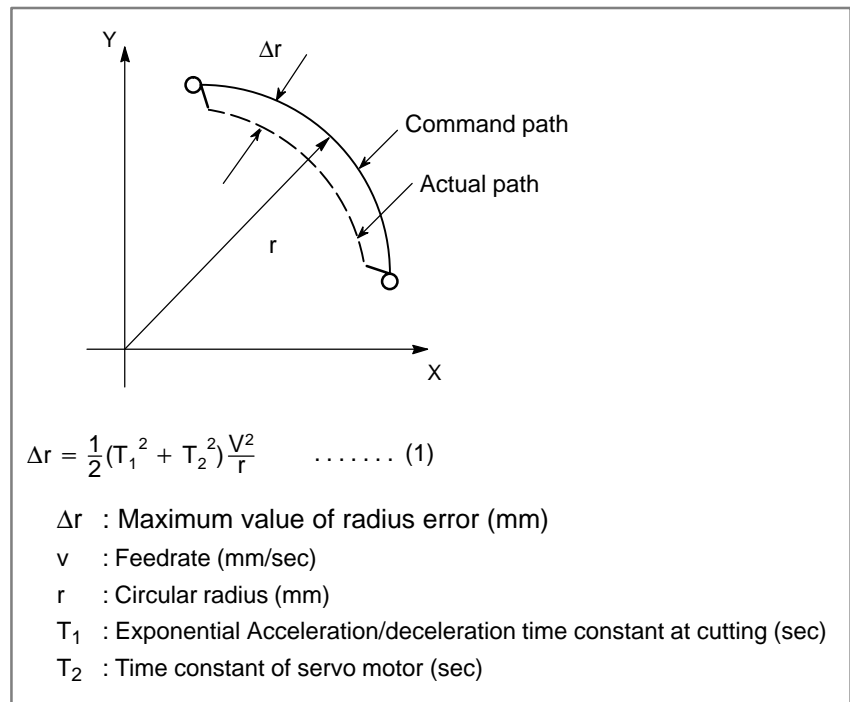

When performing the actual machining, the actual arc machining radius (r) and tolerance (Δr) are given, therefore, the maximum permissible speed v (mm/min.) can be given by the formula-(1).

”Feedrate clamp by circular radius” is such function that the circular cutting feed is automatically clamped when the feedrate designated may exceed the permissible tolerance to radial direction against the circular arc having optional radius designated by the program.

20.4 ADVANCED PREVIEW CONTROL (G08)

This function is designed for high-speed precise machining. With this function, the delay due to acceleration/deceleration and the delay in the servo system which increase as the feedrate becomes higher can be suppressed.

The tool can then follow specified values accurately and errors in the machining profile can be reduced.

This function becomes effective when advanced preview control mode is entered.

Format

G08 P_ ;

P1 : Turn on advanced preview control mode.

P0 : Turn off advanced preview control mode.

In advanced preview control mode, the following functions are available :

- Linear acceleration/deceleration before interpolation
- Automatic corner deceleration function

20.5 REMOTE BUFFER

20.5.1 Remote Buffer (Only at 1-path Control)

When the remote buffer is connected to the host computer or input/output device via serial interface, a great amount of data can be sent to CNC consecutively at a high speed.

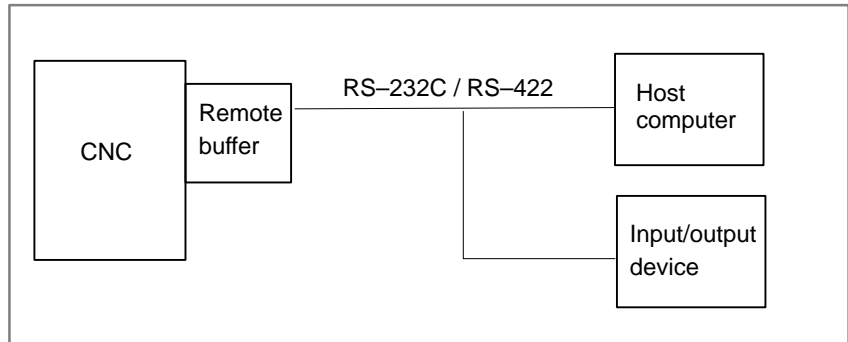

The remote buffer enables the following operations:

- When connected to the host computer online, it performs DNC operation with high reliability and at a high speed.
- The CNC program and parameters can be down-loaded from the host computer.
- When connected to an input/output device, it enables DNC operation, and various data can be down-loaded. The following input/output devices can be connected.
 - FANUC PPR
 - FANUC FA Card
 - FANUC FLOPPY CASSETTE
 - FANUC PROGRAM FILE Mate
 - FANUC Handy File

Explanations

- **Interface between the remote buffer and host computer**

Electrical interface

The following two types of interface are prepared as standard specifications.

- RS-232C Interface
- RS-422 Interface

	RS-233C	RS-422
Interface	Serial voltage interface (start-stop)	Balanced transmission serial interface (start-stop)
Baud rate	50 to 19,200 BPS	50 to 86,400 BPS (*1)
Cable length	4800 BPS or less 9600 BPS Varies according to I/O device.	Approx. 800 m (9600 BPS or less) 19,200 BPS or more

- **Software interface**

The following three protocols are prepared as the communication protocols between the remote buffer and host computer. The protocol can be selected by a parameter according to the specifications of the device to be connected.

Protocol	Features	Interface	Maximum transfer rate
Protocol A	Handshake method. Sending and receiving are repeated between two stations.	RS-232C	19200 BPS
		RS-422	86400 BPS
Extended protocol A	Similar to protocol A. Enables high-speed transfer of the NC program to meet high-speed DNC operation.	RS-422	86400 BPS
Protocol B	Controls communication with control codes output from the remote buffer.	RS-232C	19200 BPS
		RS-422	86400 BPS

NOTE

The average data transfer rate is lower than the maximum transfer rate.

20.5.2 High-speed Remote Buffer A (G05) (Only at 1-path Control)

Specify G05 only in a block using normal CNC command format. Then specify move data in the special format explained below. When zero is specified as the travel distance along all axes, normal CNC command format can be used again for subsequent command specification.

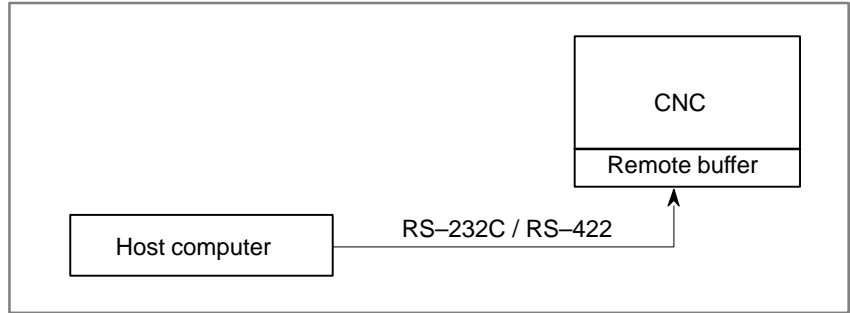

Format

- Binary input operation enabled : G05;
 - Binary input operation disabled : The travel distance along all axes are set to zero.
- Data format for binary input operation

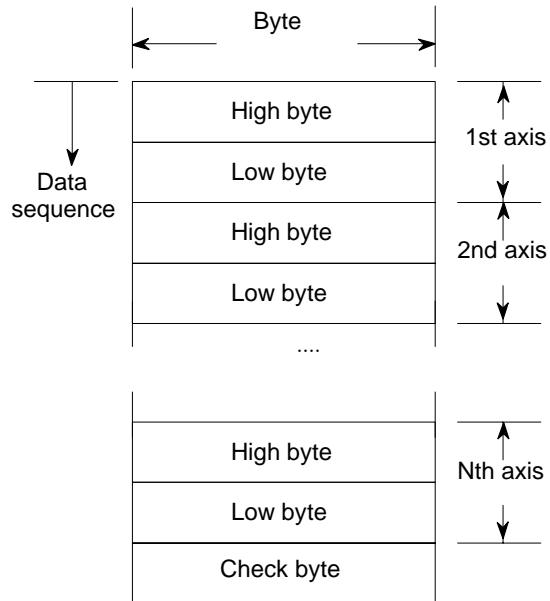

In the data format for binary input operation, the travel distance along each axis (2 bytes) per unit time is specified. The travel distances along all axes are placed sequentially from the first axis, then a check byte is added. (The data length for one block is $[2 \times N + 1]$ bytes). All data must be specified in binary.

20.5.3 **M series** High-speed Remote Buffer B (G05) (Only at 1-path Control)

High-speed remote buffer A uses binary data. On the other hand, high-speed remote buffer B can directly use NC language coded with equipment such as an automatic programming unit to perform high-speed machining.

Format

```
G05 P01 ;    Start high-speed machining
G05 P00 ;    End high-speed machining

Example) O1234 ;
      :
      G05P01 ; ← Start high-speed machining
      X_ Y_ Z_ ;
      :
      G05P00 ; ← End high-speed machining
      :
      M02 ;
```

20.6 **M series**
HIGH-PRECISION CONTOUR CONTROL (ONLY AT ONE-PATH CONTROL)

Machining errors by CNC include those caused by acceleration/deceleration after interpolation. To prevent such errors, the RISC processor provides the following functions:

- Acceleration/deceleration before interpolation by pre-reading multiple blocks. Because executed before interpolation, acceleration/deceleration does not cause a machining error.
- Automatic velocity control by smooth acceleration/deceleration. By pre-reading multiple blocks, changes in the profile and speed, and the allowable acceleration of the machine can be taken into consideration to execute smooth acceleration/deceleration.

Smooth acceleration/deceleration increases the feed-forward coefficient. As a result, the tracking error of the servo system can be reduced.

20.6.1
Acceleration/Deceleration Before Interpolation by Pre-reading Multiple Blocks

When cutting feed per minute is specified, tens of blocks are pre-read. The linear acceleration/deceleration is executed for the command speed before interpolation.

If acceleration/deceleration is executed after interpolation, the interpolation data is changed.

If it is executed for the feedrate before interpolation, the interpolation data is not affected.

Since the interpolation data can always be placed on the specified line or curve, there will be no machining profile error caused by acceleration/deceleration.

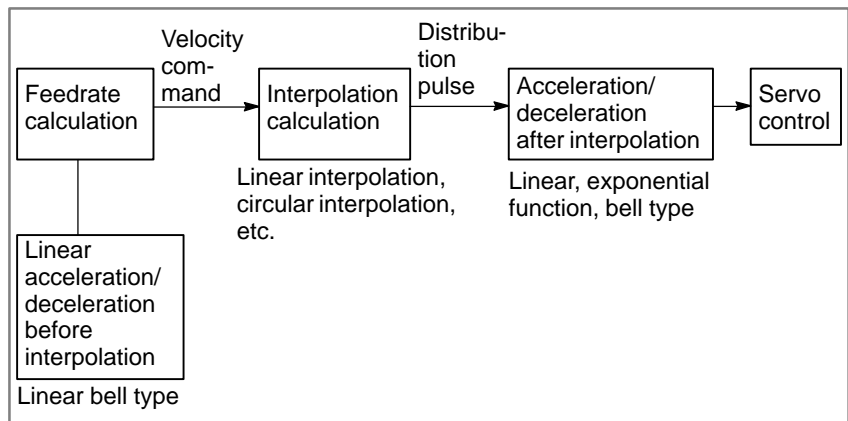

A change in feedrates for each axis on the junction of two blocks (corner section) may be greater than the value set in the parameter. In such a case, the appropriate feedrate (reduced speed) is calculated so that the change is within the set value at the corner. The feedrate in the former block automatically reduces to the calculated value.

20.6.2 Automatic Velocity Control Function

This function pre-reads several blocks, and automatically controls the feedrate.

The feedrate is determined on the basis of the following items. If the command speed exceeds the feedrate, acceleration/deceleration before interpolation is executed to reduce the speed.

- Change in speed for each axis at the corner, and allowable speed change specified
- Acceleration expected for each axis, and allowable acceleration specified
- Change in cutting load estimated by direction of Z-axis movement

In the automatic velocity control mode, acceleration/deceleration is executed before interpolation. The speed is then reduced automatically so that the machine is not shocked much.

Therefore, the time constant for automatic velocity control should be reduced, and the feed-forward coefficient should be increased. The machining error caused by delay of acceleration/deceleration or the servo system is then reduced.

20.7 **M series** AI CONTOUR CONTROL (G05.1)

By taking full advantage of high-precision contour control using a RISC processor, this function enables high-speed high-precision machining without the need for special hardware.

The function enables look-ahead linear acceleration/deceleration before interpolation of up to 15 blocks. This results in smooth acceleration/deceleration over many blocks, as well as high-speed machining.

Format

G05.1 Q_ ;

Q1 : Start AI contour control mode

Q0 : End AI contour control mode

G05.1 A block for specifying G05.1 must not contain any other command.

AI contour control mode can also be canceled by a reset.

20.8 **M series** HIGH-SPEED LINEAR INTERPOLATION (G05)

The high-speed linear interpolation function processes a move command related to a controlled axis not by ordinary linear interpolation but by high-speed linear interpolation. The function enables the high-speed execution of an NC program including a series of minute amounts of travel.

Format

G05 P2 ; Start high-speed linear interpolation

G05 P0 ; End high-speed linear interpolation

G05 A block for specifying G05 must not contain any other command.

20.9 AI HIGH-PRECISION CONTOUR CONTROL/ AI NANO HIGH- PRECISION CONTOUR CONTROL

AI high-precision contour control is designed to enable high-speed, high-precision machining with programs that specify successive minute line segments or NURBS curves like die machining. Use of this function suppresses the delay due to acceleration/deceleration and delay in the servo system that increase as the feedrate increases. This function, therefore, can have the tool follow specified values accurately and reduce errors in machining profile, enabling high-speed, high-precision machining. Under AI high-precision contour control, acceleration/deceleration is performed more exactly than under conventional high-precision contour control, so machining can speed up.

AI nano high-precision contour control allows simultaneous use of nano interpolation while providing all features of AI high-precision contour control. The unit of output from the NC to servo system is usually the detection unit. In nano interpolation, output to the servo system is done in units of 1/1000 of the detection unit to improve machining precision. This function is particularly effective in the improvement of surface roughness. The positioning accuracy, however, depends on the machine conditions such as the resolution of the detector. This function is most effective when the resolution of the detector is smaller than the detection unit. Even if the resolution of the detector is the same as the detection unit (for example, in case of a closed loop), this function is effective when the feed-forward function is used.

AI nano high-precision contour control is the same as AI high-precision contour control except AI nano high-precision contour control allows use of nano interpolation. The following describes AI high-precision contour control only.

Format

The commands shown below turn AI high-precision contour control mode on and off. In AI high-precision contour control mode, "AI HPC" blinks in the lower right part of the screen. In AI nano high-precision contour control mode, "NANO HP" blinks.

G05 P10000	: Turn on AI high-precision contour control mode.
G05 P0	: Turn off AI high-precision contour control mode.

A block for specifying G05 must not contain any other command.

Available functions

In AI high-precision contour control mode, the functions listed below are available. For minute line segments and curves such as NURBS interpolation, high-speed, high-precision machining is possible.

- (1) Linear acceleration/deceleration before interpolation or bell-shaped acceleration/deceleration before interpolation (with the period for changing the acceleration held constant)
- (2) Deceleration by difference in feedrate in a corner
- (3) Advanced preview feed-forward function
- (4) Feedrate determined by acceleration on each axis
- (5) Deceleration by cutting load
- (6) 200-block multi-buffer function

Feedrate control method

In fine HPCC mode, the feedrate is controlled automatically by look-ahead operation for blocks. The feedrate is determined according to the conditions listed below. If a specified feedrate exceeds the determined feedrate, acceleration/deceleration before interpolation is performed to achieve the determined feedrate.

- (1) Change in feedrate along each axis in a corner and specified permissible feedrate change amount
- (2) Expected acceleration on each axis and specified permissible acceleration
- (3) Change in expected cutting load from the direction of movement along the Z-axis

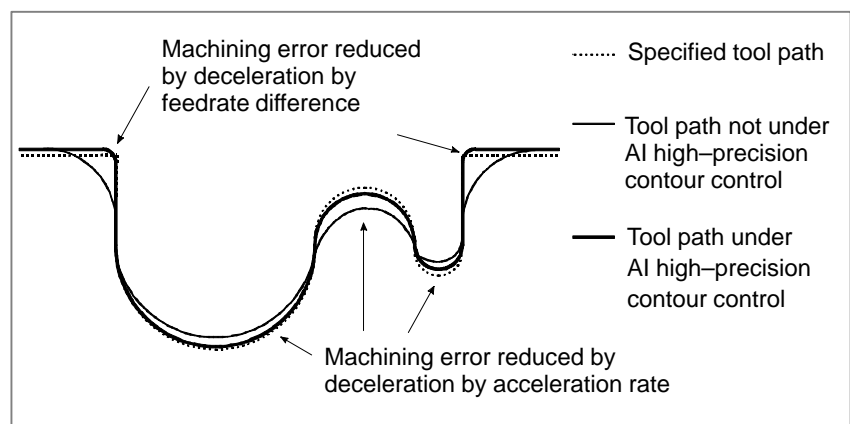

Fig. 20.9

To enable this function, set the following parameters:

Parameter No. 8410 : Permissible feedrate difference used to determine the feedrate by difference in feedrate at a corner

Parameter No. 8470 : Determines the permissible acceleration used to determine the feedrate by acceleration

For details, see the explanation of the parameters.

20.10 AI NANO CONTOUR CONTROL (G05.1)

This function fully utilizes know-how of high-precision contour control using a RISC processor to implement high-speed, high-precision machining without using special hardware.

Look-ahead acceleration/deceleration before interpolation is enabled for up to 180 blocks. As a result, smooth acceleration/deceleration through many blocks can be performed, so high-speed machining is possible. In addition, nano interpolation calculates position commands to be output to the digital servo system in nanometers (nm), which results in smooth machine movement and improved surface accuracy.

Format

G05.1 Q_ ;
Q1 : Turn on AI nano contour control mode.
Q0 : Turn off AI nano contour control mode.
A block for specifying G05.1 must not contain any other command.
AI nano contour control mode can be released also by reset operation.

20.11 M series AI ADVANCED PREVIEW CONTROL (FOR THE 21i-M ONLY) (G05.1)

This function fully utilizes know-how of high-precision contour control using a RISC processor to implement high-speed, high-precision machining without using special hardware.

Look-ahead acceleration/deceleration before interpolation is enabled for up to 15 blocks. As a result, smooth acceleration/deceleration through many blocks can be performed, so high-speed machining is possible.

Format

G05.1 Q_ ;
Q1 : Turn on AI advanced preview control mode.
A0 : Turn off AI advanced preview control mode.
A block for specifying G05.1 must not contain any other command.
AI advanced preview control mode can be released also by reset operation.

20.12 **M series**
LOOK-AHEAD
BELL-SHAPED
ACCELERATION/
DECELERATION
BEFORE
INTERPOLATION
TIME CONSTANT
CHANGE FUNCTION

In Look-ahead bell-shaped acceleration/deceleration before interpolation, the speed during acceleration/deceleration is as shown in the figure below.

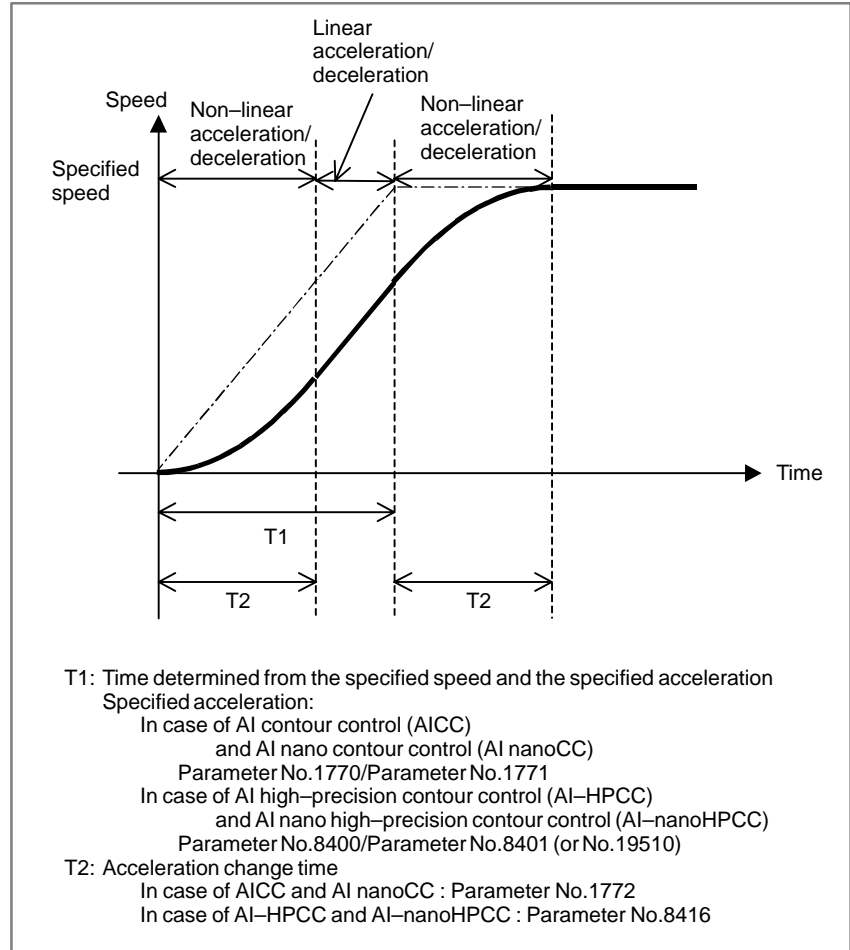

Fig 20.12 (a)

The time T1, shown above, varies with the specified speed. If the specified speed is low, the speed will be as shown below, causing linear acceleration/deceleration not reaching the specified acceleration.

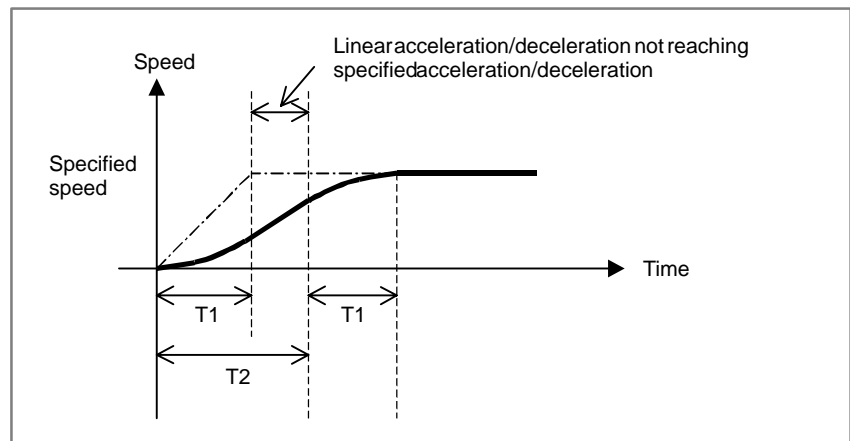

Fig 20.12 (b)

If linear acceleration/deceleration not reaching the specified acceleration occurs in AI contour control (AICC) mode, AI Nano contour control (AI nanoCC) mode, AI High Precision Contour control (AI-HPCC) mode, AI Nano High Precision Contour control (AI-nanoHPCC) mode as shown above, this function shortens the acceleration/deceleration time by changing the internal acceleration for acceleration/deceleration before interpolation and the bell-shaped time constant in order to generate an acceleration/deceleration pattern as close as possible to that permits optimum bell-shaped acceleration/deceleration before interpolation for the specified speed.

Optimum bell-shaped acceleration/deceleration before interpolation, as mentioned here, refers to bell-shaped acceleration/deceleration before interpolation in which

if $T2 > T1$, $T1$ and $T2$ are changed to $T1'$ and $T2'$ as shown in the figure below so that linear acceleration/deceleration not reaching the specified acceleration/deceleration does not occur.

This function becomes effective for the Acceleration /deceleration before look-ahead interpolation in AI contour control mode or AI Nano contour control mode or AI High Precision Contour control mode or AI Nano Contour control mode..

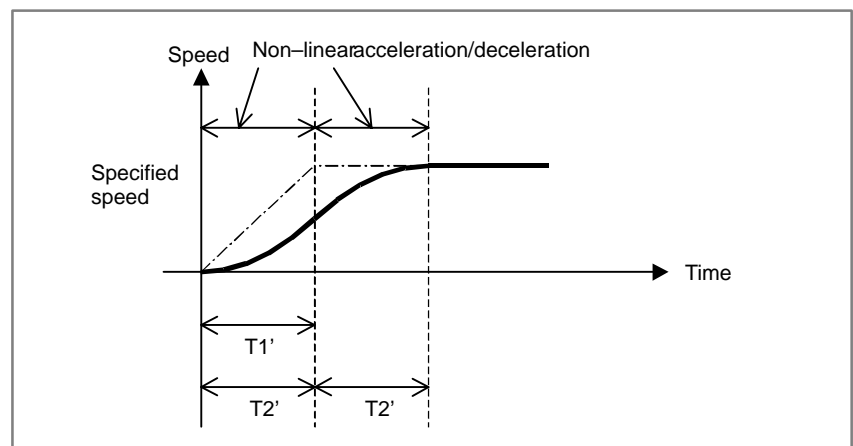

Fig 20.12 (c)

NOTE

This function is included in following optional function.

- AI contour control
- AI nano contour control
- AI high-precision contour control
- AI nano high-precision contour control

20.13 OPTIMUM TORQUE ACCELERATION/ DECELERATION

This function enables acceleration/deceleration in accordance with the torque characteristics of the motor and the characteristics of the machines due to its friction and gravity and performs linear type positioning with optimum acceleration/deceleration during AI high precision contour control mode or AI nano high precision contour control mode.

Usually, because of the friction of the machine, gravity, the torque characteristics of the motor, and other factors, the acceleration/ deceleration performance (torque for acceleration/deceleration) is different with direction of movement, acceleration or deceleration. In this function, acceleration pattern of rapid traverse for the following situations, plus movement and acceleration, plus movement and deceleration, minus movement and acceleration, minus movement and deceleration can be set into parameters according to the torque for acceleration/deceleration of each situation. Acceleration/deceleration can be performed according to these parameter setting, so that the most of the capability of the motor can be used and positioning time can be reduced.

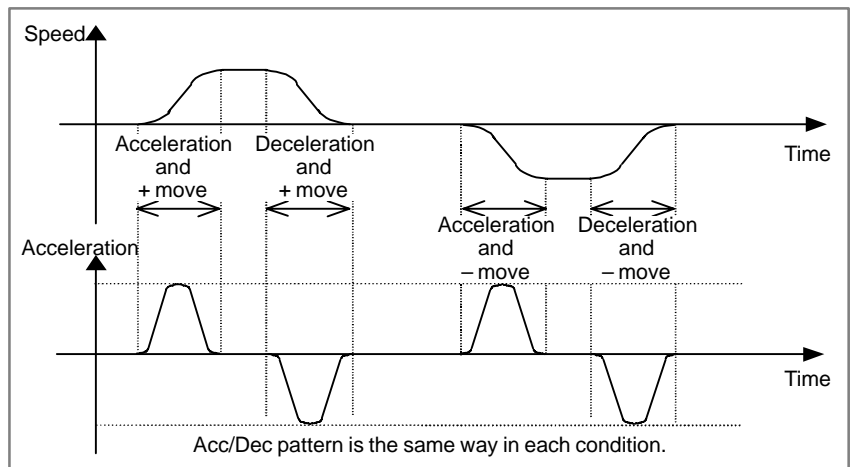

Fig 20.13 (a) Conventional acceleration/declaration

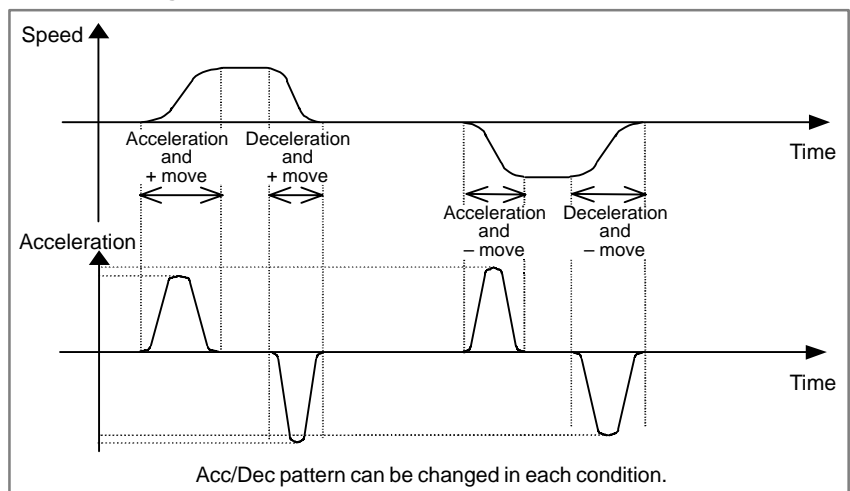

Fig 20.13 (b) Acceleration/deceleration with this function

NOTE

This function is included in following optional function.

- AI high-precision contour control
- AI nano high-precision contour control

21

AXES CONTROL



21.1 FOLLOW UP FUNCTION

Normally, the machine is controlled to move to a commanded position. However, when the follow up function is applied, actual position in the CNC is revised according to the move of the machine.

Follow up function is activated when:

- Emergency stop is on

Because machine movement during the emergency stop is reported, the actual position of the machine is reflected in the CNC. Therefore, machining can be resumed after the emergency stop has been deactivated, without performing the reference point return again.

However, when a trouble has generated in the position detection system, the system cannot follow up correctly. So present position in CNC does not become correct value.

By input signal (follow up signal) from PMC follow up function can also be applied to:

- Servo off

status. It is also valid in cases when the machine is moved with a mechanical handle.

21.2 MECHANICAL HANDLE FEED

It is possible to move the machine by hand, using the mechanical handle installed on the machine; not by the NC (servo motor).

Move distance by the mechanical handle is followed up and actual position in The NC is revised. The mechanical handle feed is done by inputting the servo off signal of the axis fed. It is necessary, however, to specify following up of the movement in the servo off status with the follow up signal.

21.3 SERVO OFF

Servo on/off control per axis is possible by input signals from PMC. This function is generally used with the machine clamp.

21.4 MIRROR IMAGE

The MDI-commanded or the program-commanded move direction of each axis can be reversed and executed.

Mirror image is set by MDI setting or by input signals from PMC.

Mirror image can be applied to each axis.

21.5 CONTROL AXIS DETACH

It is possible to detach or attach rotary tables and attachments with this function. Switch control axis detach signal according to whether the rotary tables and attachments are attached or detached. When this signal is on, the corresponding axis is excluded from the control axes, so the servo alarm applied to the axis are ignored. The axis is automatically regarded as being interlocked. This signal is not only accepted when power turned is on, so automatic change of attachments is possible any time with this function.

The same switching as with this signal can also be performed with the MDI setting.

21.6 SIMPLE SYNCHRONOUS CONTROL

An input signal from PMC can be used to select whether simple synchronization control is performed. During simple synchronization control, the move command for the master axis is issued to the two motors of the master and slave axes for synchronization control of the two axes. However, there are no functions for performing synchronization compensation so that the positional deviations of the master and slave axes are equalized by constantly monitoring these positional deviations. Even during simple synchronization control, pitch error compensation and backlash compensation for the master axis are performed separately from those for the slave axis.

The following shows the differences in simple synchronization control between the M series and the T series.

For M series

- Operation modes that allow simple synchronization control
Automatic operation, Jog feed, Manual handle feed, Incremental feed, and Manual Reference position return
- Number of synchronized pairs
Up to four (depending on the number of control axes)
- Other functions
Synchronization error check (positional deviation/machine coordinates)
Synchronization (During power-up of the CNC, the departure generated during power-down of the CNC is automatically compensated. However, the absolute-position detectors are required for the master and slave axes.)
Automatic grid positioning
Torque difference alarm

For T series

- Operation modes that allow simple synchronization control
Automatic operation only (disabled during manual operation)
- Number of synchronized pairs
One
- Other functions
None

21.7 **T series** SYNCHRONIZATION CONTROL (ONLY AT 1-PATH CONTROL)

The synchronization control function enables the synchronization of movements on two axes. If a move command is programmed for one of those two axes (master axis), the function automatically issues the same command to the other axis (slave axis), thus establishing synchronization between the two axes. The parking state can be selected to suppress movement of the slave axis, even if a move command is specified for the master axis. If the parking state is used with the synchronization control function, the operation can be controlled as follows:

- (1) Synchronizes the movement on the slave axis with that of the master axis.
- (2) Performs slave axis movement according to the move command programmed for the master axis. However, the movement specified by the command is not made for the master axis itself (master parking).
- (3) Updates the slave axis coordinates according to the distance travelled along the master axis. However, no movement is made for the slave axis (slave parking).

CAUTION

In the synchronization control described above, an identical move command is simultaneously output for two servo processing systems. Positional error between the two servo motors is not monitored nor is either servo motor adjusted to minimize the error. That is, synchronization error compensation is not carried out.

21.8 FEED STOP

This function usually checks position deviation amount during motion. If the amount exceeds the parameter set “feed stop position deviation amount”, pulse distribution and acceleration/deceleration control is stopped for the while exceeding, and move command to the positioning control circuit is stopped.

The overshoot at rapid feed acceleration is thus kept to a minimum.

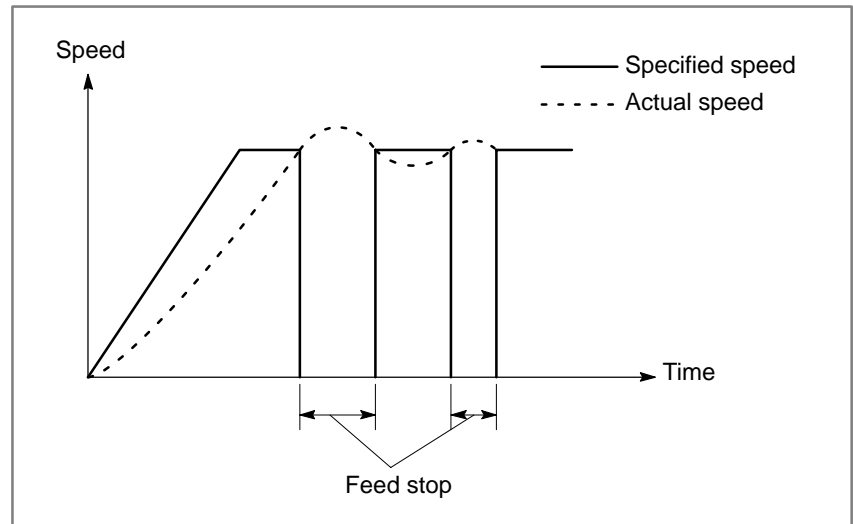

21.9 M series NORMAL DIRECTION CONTROL (G40.1,G41.1,G42.1)

Format

The rotation axis (C axis) can be controlled by commanding the G41.1 or G42.1 so that the tool constantly faces the direction perpendicular to the advancing direction during cutting.

- G40.1** : Normal direction control cancellation mode
(No normal direction control can be performed.)
- G41.1** : Normal direction control left side on
(Control is made to allow facing perpendicular to advancing direction to the left)
- G42.1** : Normal direction control right side on
(Control is made to allow facing perpendicular to advancing direction to the right)

In the normal direction control, control is made so that the tool may be perpendicular to the advancing direction on the X-Y plane.

With the angle of C axis, the +X direction is defined to be 0 degrees viewed from the rotation center of C axis. Then, the +Y direction, -X direction, and -Y direction are defined to be 90, 180, and 270 degrees, respectively.

When shifting to the normal direction control mode from the cancellation mode, the C axis becomes perpendicular to the advancing direction where the G41.1 or G42.1 is at the starting point of commanded block.

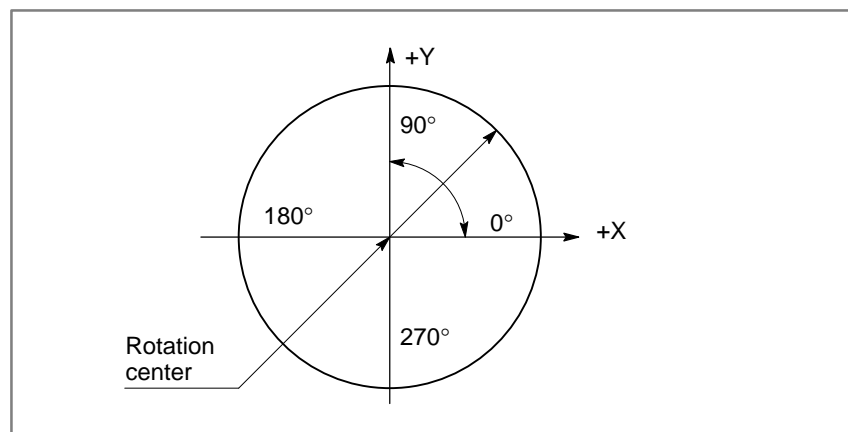

Between blocks, the traveling of C axis is automatically inserted so that the C axis faces the normal direction at the starting point of each block according to the change of traveling direction.

Normal direction control is performed for the path after compensation during the cutter compensation mode. The feed rate of rotation of C axis inserted at the starting point of each block becomes the federate set by parameters. However, when dry run is valid, the feed rate is set to the dry run rate. Also, in the case of rapid traverse (GOO), it becomes the rapid traverse rate. In the case of circular command, the C axis is allowed to be rotated first so that the C axis faces perpendicular to the circular starting point. At this time, the C axis is controlled so that it constantly faces the normal direction along with the move of circular command.

NOTE

The rotation of C axis during normal direction control is controlled at short distance so that 180 degrees or less may result.

21.10 POLYGONAL TURNING (G50.2, G51.2)

T series

A polygonal figure can be machined by turning the workpiece and tool at a certain ratio.

- Rotation ratio of the workpiece and tool
- Number of tool teeth

The polygon can be a quadrilateral or hexagon according to the above machining conditions.

Compared with the machining performed by using C and X axes with polar-coordinate compensation, this machining requires shorter time. It, however, cannot form a precise figure of a polygon. Generally, this method is used for machining of square or hexagonal bolt heads or hexagonal nuts.

Example)

Rotation ratio of the workpiece and tool : 1 : 2

Number of teeth : Three at every 120° (for a hexagon)

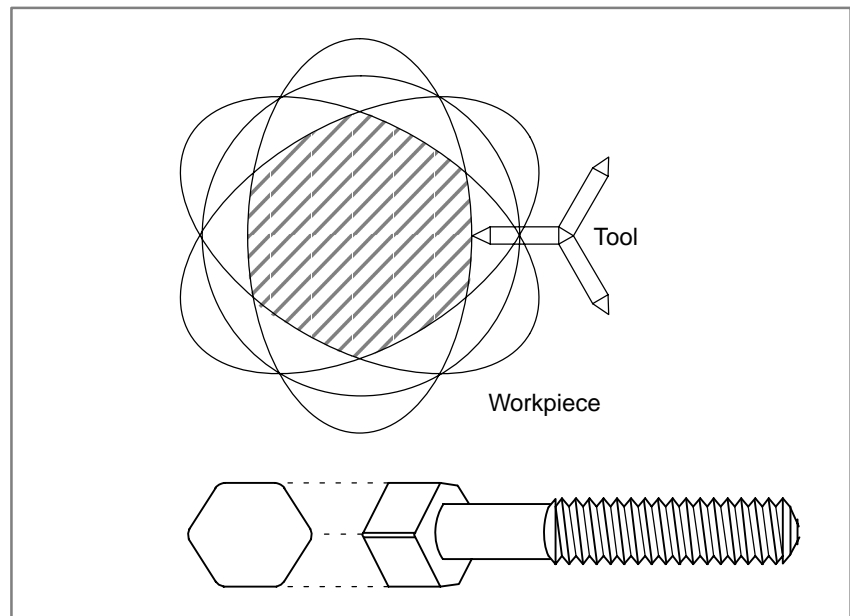

The rotation of the tool for polygonal turning is controlled by the CNC control axis. Hereafter, the rotation axis of this tool is called B axis.

Command G51.2 controls the B axis so that the ratio of the tool speed to the speed of the workpiece (specified by the S command beforehand) attached to the spindle becomes the specified value.

The synchronization between the spindle and B axis is canceled by the command below.

G50.2 ;

Format**G51.2 P_ Q_ ;**

P and Q: Rotation ratio of spindle to B axis

Command range : Integer value of 1 to 9 for both P and Q

When the value of Q is positive, the rotation direction of B axis is in positive direction.

When the value of Q is negative, the rotation direction of B axis is in negative direction.

(Example) When the rotation ratio of spindle to B axis is equal to 1 : 2 and the rotation direction of B axis is positive direction
G51.2 P1 Q2 ;

G50.2 ; Cancel

When synchronous start is commanded by the G51.2, one rotation signal from the position coder mounted in the spindle is detected and the rotation of B axis is controlled while being synchronous with the rate of spindle in response to the rotation ratio (P : Q). Namely, control is made so that the ratio of spindle to B axis is P : Q. This relationship continues until the synchronous cancellation command (G50.2 or reset) are carried out. The direction of rotation of B axis is determined by the symbol Q and is not affected by the direction of rotation of position coder. When the G50.2 is commanded, the synchronization of the spindle and B axis is canceled and the B axis is stopped.

21.11 **T series** POLYGONAL TURNING WITH TWO SPINDLES

In the polygonal turning with two spindles, the first spindle is used as a workpiece rotation axis (master axis). The second spindle is used as a tool rotation axis (polygon synchronization axis). Spindle rotation control is applied to both spindles with a constant ratio.

The polygonal turning with two spindles can use different spindle speeds for the same workpiece, because it performs automatic phase compensation when a polygon synchronization mode command is issued or the S command is changed during polygon synchronization mode. With this function, it is also possible to specify the phase difference between the master and polygon synchronization axes.

21.12 AXIS CONTROL WITH PMC

The PMC can directly control any given axis, independently of the CNC. In other words, moving the tool along axes that are not controlled by the CNC is possible by entering commands, such as those specifying moving distance and feedrate, from the PMC. This enables the control of turrets, pallets, index tables and other peripheral devices using any given axes of the CNC.

Whether the CNC or PMC controls an axis is determined by the input signal provided for that particular axis.

The PMC can directly control the following operations :

- (1) Rapid traverse with moving distance specified
- (2) Cutting feed—feed per minute, with moving distance specified
- (3) Cutting feed—feed per revolution, with moving distance specified
- (4) Skip—feed per minute, with moving distance specified
- (5) Dwell
- (6) Continuous feed
- (7) Reference position return
- (8) 1st reference position return
- (9) 2nd reference position return
- (10) 3rd reference position return
- (11) 4th reference position return
- (12) External pulse synchronization—Main spindle
- (13) External pulse synchronization—first manual handle
- (14) External pulse synchronization—second manual handle
- (15) External pulse synchronization—third manual handle (for M series only)
- (16) Feedrate control
- (17) Auxiliary function, Auxiliary function 2, Auxiliary function 3
- (18) Selection of the machine coordinate system
- (19) Torque control command

The PMC is provided with four paths to control these operations using input and output signals.

By issuing commands through these four paths, the PMC can simultaneously control multiple axes separately. Use parameter to determine which path controls which axis. Commands may be issued through one path to two or more axes, thus allowing the PMC to control multiple axes using one path.

21.13 ANGULAR AXIS CONTROL

For T series, even if the X axis is not vertical to the Z axis (for T series, the Y axis not vertical to the Z axis), they are assumed to form a orthogonal coordinate system, simplifying programming. The movement of each axis is automatically controlled according to the slant angle.

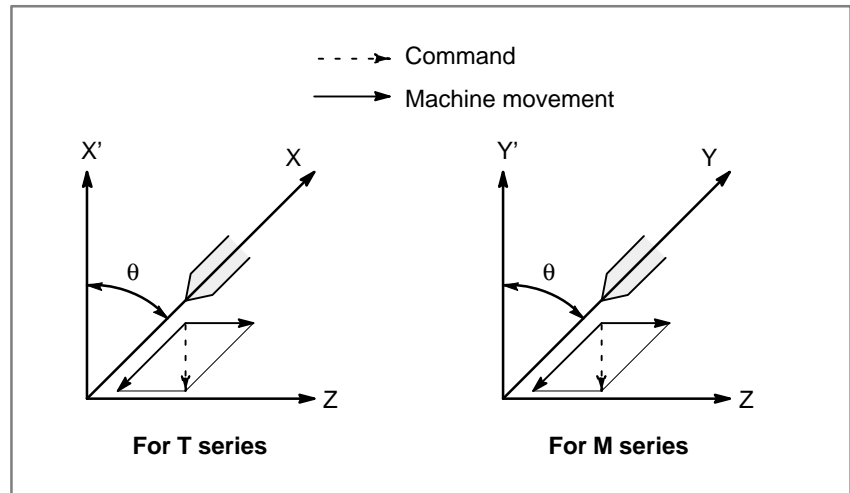

21.14 ARBITRARY ANGULAR AXIS CONTROL

For the ordinary angular axis control function of the T series, the X-axis is always used as the angular axis, while the Z-axis is always used as the perpendicular axis. (For the M series, the Y-axis is always used as the angular axis, while the Z-axis is always used as the perpendicular axis.) With arbitrary axis angular axis control, however, any axes can be specified as the angular and perpendicular axes, by specifying parameters accordingly.

21.15 T series B-AXIS CONTROL

This function sets an axis (B-axis) independent of the basic controlled axes X_1 , Z_1 , X_2 , and Z_2 and allows drilling, boring, or other machining along the B-axis, in parallel with the operations for the basic controlled axes. The X_2 and Z_2 axes can be used in two-path control mode.

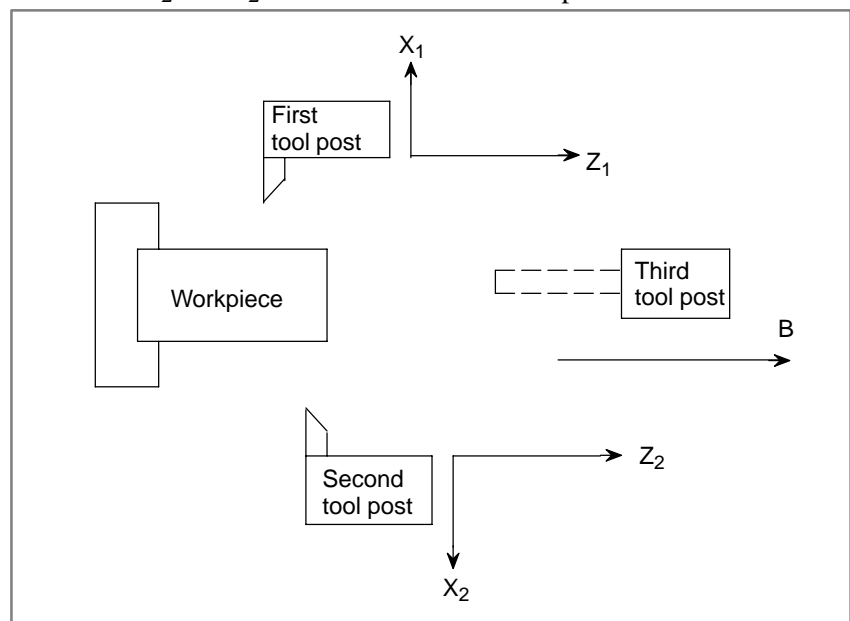

21.16 TANDEM CONTROL

When enough torque for driving a large table cannot be produced by only one motor, two motors can be used for movement along a single axis. Positioning is performed by the main motor only. The sub motor is used only to produce torque. With this tandem control function, the torque produced can be doubled.

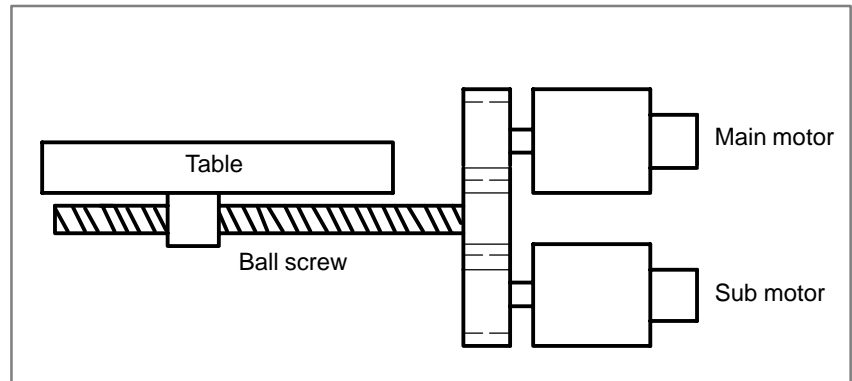

Example of operation

In general, the CNC regards tandem control as being performed for one axis. However, for servo parameter management and servo alarm monitoring, tandem control is regarded as being performed for two axes.

21.17 CHOPPING FUNCTION (G80, G81.1)

M series

When contour grinding is performed, the chopping function can be used to grind the side face of a workpiece. By means of this function, while the grinding axis (the axis with the grinding wheel) is being moved vertically, a contour program can be executed to instigate movement along other axes.

In addition, a servo delay compensation function is supported for chopping operations. When the grinding axis is moved vertically at high speed, a servo delay and acceleration/deceleration delay occur. These delays prevent the tool from actually reaching the specified position. The servo delay compensation function compensates for any displacement by increasing the feedrate. Thus, grinding can be performed almost up to the specified position.

There are two types of chopping functions: that specified by programming, and that activated by signal input.

Explanations

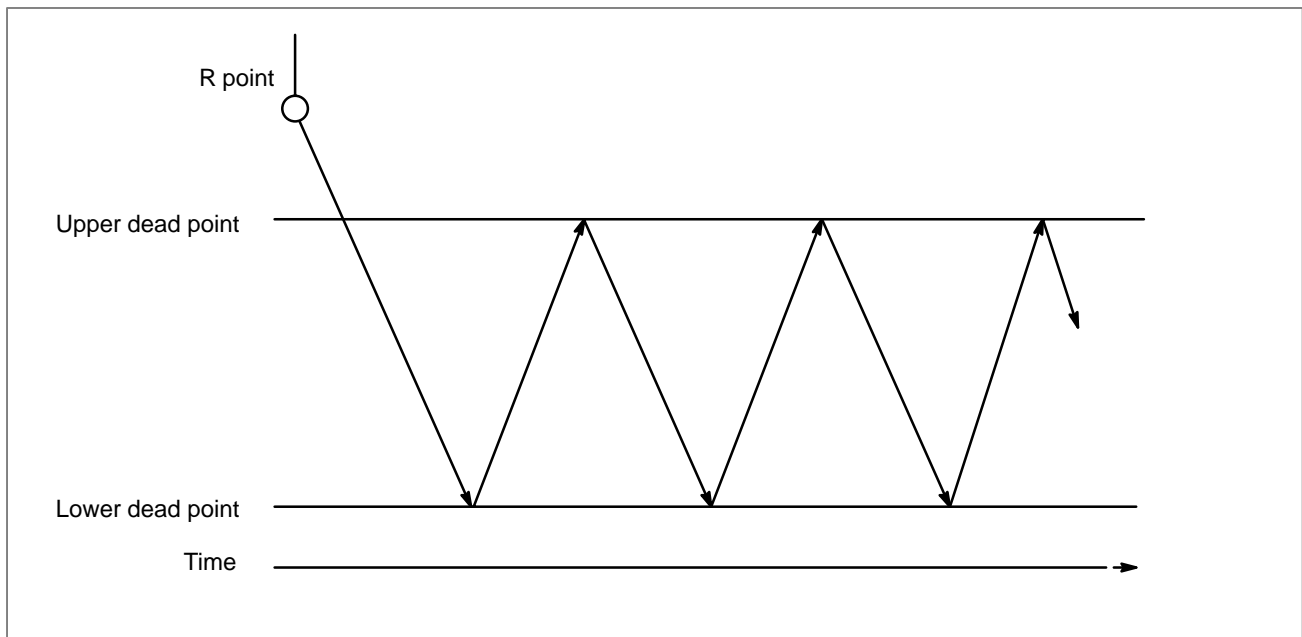

Format

G81.1 Z_ Q_ R_ F_ ;

Z : Upper dead point

(For an axis other than the Z-axis, specify the axis address.)

Q : Distance between the upper dead point and lower dead point
(Specify the distance as an incremental value, relative to the upper dead point.)

R : Distance from the upper dead point to point R

(Specify the distance as an incremental value, relative to the upper dead point.)

F : Feedrate during chopping

G80; Cancels chopping

21.18 HOB

Gears can be cut by turning the workpiece (C-axis) in sync with the rotation of the spindle (hob axis) connected to a hob.

Also, a helical gear can be cut by turning the workpiece (C-axis) in sync with the motion of the Z-axis (axial feed axis).

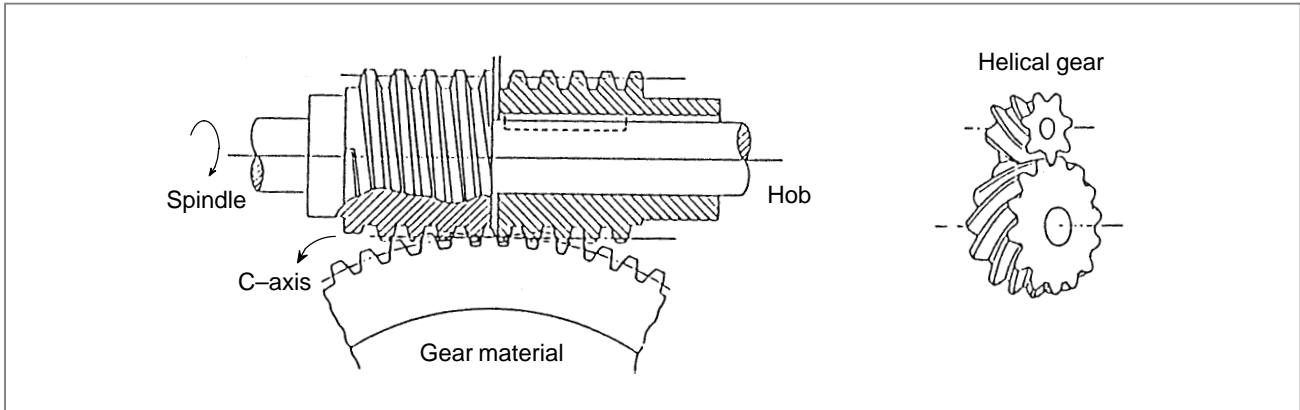

21.18.1 **M series** Hobbing Machine Function (G80, G81)

Format

G81 T _ L _ Q _ P _ ;

T : Number of teeth (Specifiable range: 1 to 5000)

L : Number of hob threads (Specifiable range: 1 to 20 with a sign)

- The sign of L specifies the direction of rotation of the C-axis.
- If L is positive, the C-axis rotates in the positive direction (+).
- If L is negative, the C-axis rotates in the negative direction (-).

Q : Module or diametral pitch

For metric input, specify a module.

(Units: 0.00001 mm, Specifiable range: 0.01 to 25.0 mm)

For inch input, specify a diametral pitch.

(Units: 0.00001 inch⁻¹, Specifiable range: 0.01 to 250.0 inch⁻¹)

P : Gear helix angle

(Units: 0.0001 deg, Specifiable range: -90.0 to +90.0 deg)

P and **Q** must be specified when a helical gear is to be cut.

G80 ; Cancels synchronization between the hob axis and C-axis.

- **G code list**

Code <M series>	Group	Function
G80	00	Cancels hobbing synchronization.
G81		Starts hobbing synchronization.
G82		Cancels the C-axis servo delay compensation.
G83		Executes the C-axis servo delay compensation.
G84		Stores the C-axis servo delay compensation.

- **Canned cycle**

Canned cycles cannot be used when the hobbing machine function is enabled.

21.18.2 T series Hobbing Function (G80.4, G81.4)

Format

G81.4 T _ L _ Q _ P _ ;

T : Number of teeth (specifiable range: 1 to 500)

L : Number of hob threads (specifiable range: 1 to 30 with a sign)

- The sign of L specifies the direction of rotation of the C-axis.
- If L is positive, the C-axis rotates in the positive direction (+).
- If L is negative, the C-axis rotates in the negative direction (-)

Q : Module or diametral pitch

For metric input, specify a module.

(Units = 0.00001 mm; specifiable range = 0.01 to 25.0 mm)

For inch input, specify a diametral pitch.

(Units = 0.00001 inch⁻¹; specifiable range = 0.01 to 250.0 inch⁻¹)

P : Gear helix angle

(Units = 0.0001 deg; specifiable range = -90.0 to +90.0 deg)

P and Q must be specified when a helical gear is to be cut.

G80.4 ; Cancels synchronization between the hob axis and C-axis.

- **G code list**

Code <T series>	Group	Function
G80.4	00	Cancels hobbing synchronization.
G81.4		Starts hobbing synchronization.
G82.4		Cancels the C-axis servo delay compensation.
G83.4		Executes the C-axis servo delay compensation.
G84.4		Stores the C-axis servo delay compensation.

- **Canned cycle**

- During hobbing synchronization, a canned cycle (G81 to G89) cannot be specified. If the prohibited specification is attempted, alarm 184 will be raised.
- In the canned cycle mode, the hobbing synchronization command G81.4 cannot be specified. If the prohibited specification is attempted, alarm 187 will be raised.

21.19 **M series**
SIMPLE ELECTRIC
GEAR BOX (G80, G81)

To machine (grind/cut) a gear, the rotation of the workpiece axis connected to a servo motor is synchronized with the rotation of the tool axis (grinding wheel/hob) connected to the spindle motor. To synchronize the tool axis with the workpiece axis, an electric gear box (EGB) function is used for direct control using a digital servo system. With the EGB function, the workpiece axis can trace tool axis speed variations without causing an error, thus machining gears with great precision.

A dedicated servo axis is also used for the tool axis, connected to the spindle motor and for which the rotational position must be read directly by the digital servo system (this axis is called the EGB axis).

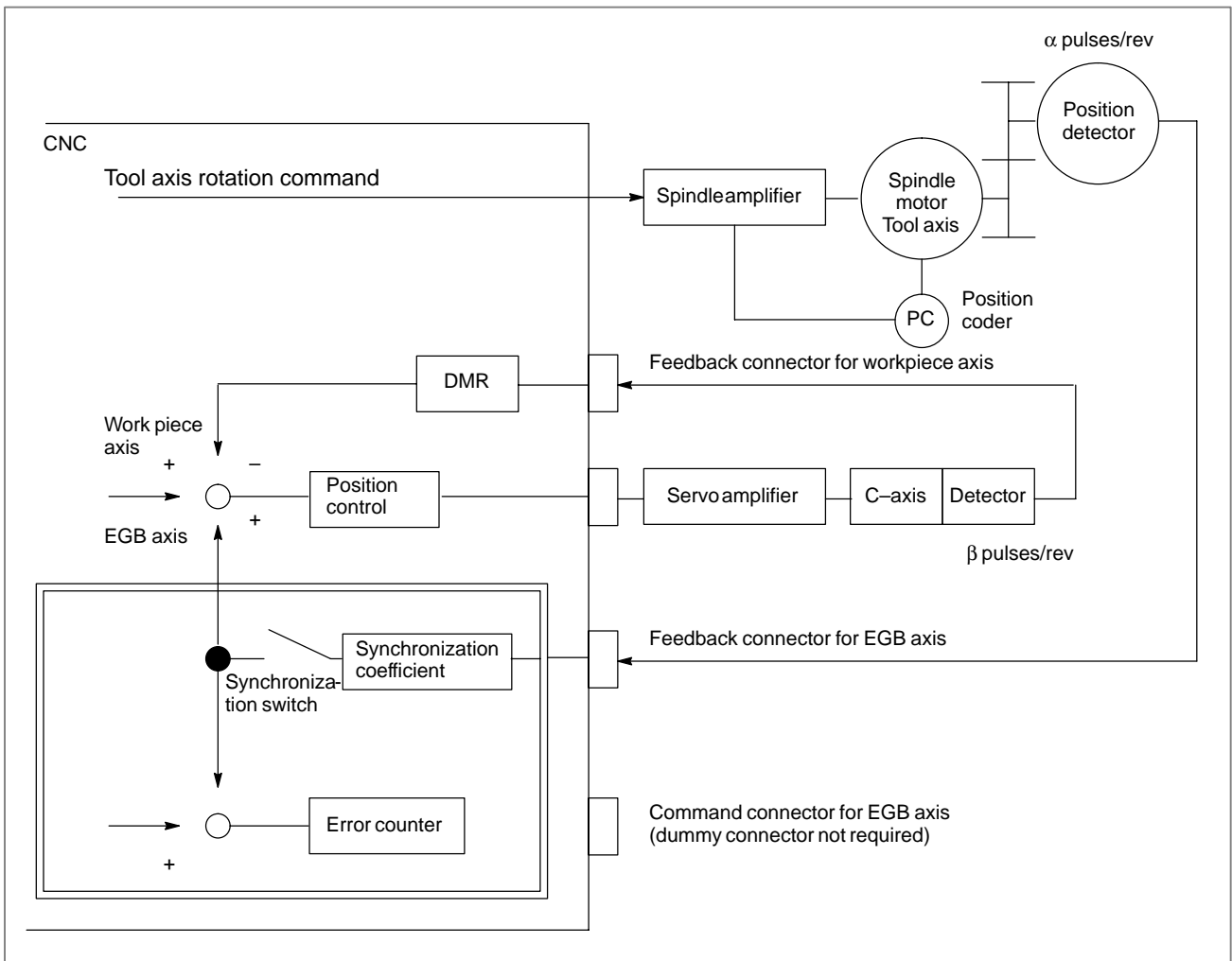

Format

G81 T _ L _ Q _ P _ ; Starts synchronization.
 T : Number of teeth
 L : Number of hob threads
 Q : Module or diametral pitch
 Specify a module in the case of metric input.
 Specify a diametral pitch in the case of inch input.
 P : Gear helix angle
G80: Cancels synchronization

21.20 **M series** SKIP FUNCTION FOR EGB AXIS

This function validates a skip signal or high-speed skip signal for the workpiece axis in the synchronization mode set by the EGB (Electronic Gear Box) function.

This function has these features.

- The block with this function is not interrupted until the skip signal input has been counted to the commanded times.
- The synchronization mode set by the EGB is not canceled by a skip signal.
- The machine coordinates when a skip signal is input are stored in specified custom macro variables successively.
- The number of times a specified skip signal is input is stored in a custom macro variable.

Format

G31.8 G91 α 0 P_ Q_ R_ ; (EGB skip command)

α : EGB axis (Workpiece axis)

P : The top number of custom macro variables in which the value of machine coordinate is set when skip signal is input.

Q : The total times of skip signal input during execution of the block with G31.8.

R : The number of custom macro variable in which the total number of times of skip signal inputs is set.

21.21 M series ELECTRIC GEAR BOX TWO PAIR

This function is a function for rotating a workpiece in sync with a rotating tool, or to move a tool in sync with a rotating workpiece. With this function, the high-precision machining of gears, threads, and the like can be implemented. A desired synchronization ratio can be programmed. Up to two sets of axes can be synchronized. A gear grinding machine can be controlled, for instance, by using one axis for rotating the workpiece in sync with the tool and another axis for performing dressing in sync with the tool.

The specification method differs depending on the configuration of the machine. For details, refer to the manual supplied by the machine tool builder.

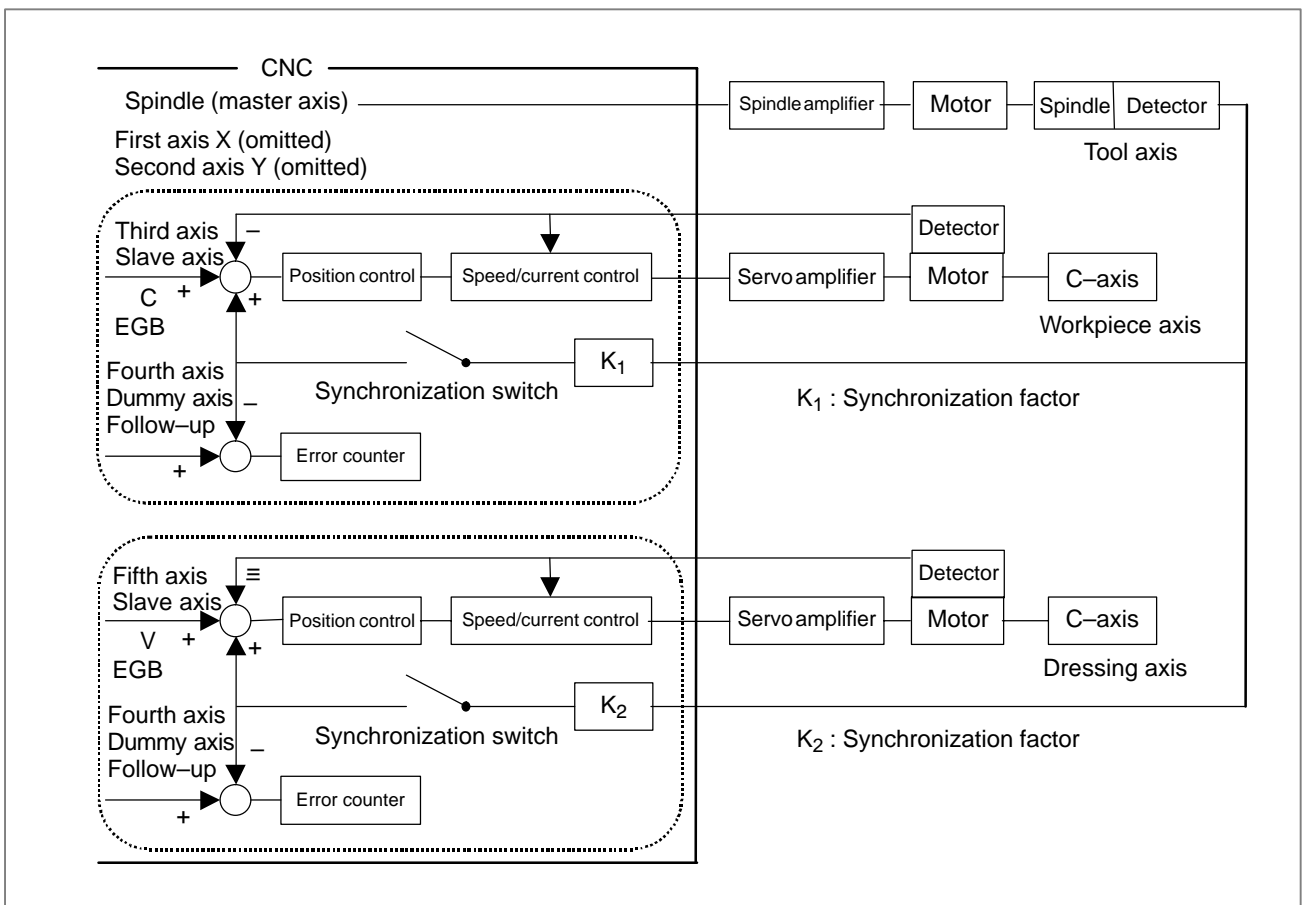

Format

$$\mathbf{G81.5} \left\{ \begin{array}{l} \mathbf{Tt} \\ \mathbf{Pp} \end{array} \right\} \left\{ \begin{array}{l} \beta \mathbf{j} \\ \beta \mathbf{0 L1} \end{array} \right\} ;$$

Amount of travel relative to the master axis (Specify either Tt or Pp.)

Tt : Speed of the master axis

Pp : Number of pulses for the master axis

Amount of travel relative to the slave axis (Specify either βj or $\beta 0L1$.)

βj : β is the address of a slave axis.

j is the amount of travel along the slave axis.

$\beta 0L\pm 1$: β is the address of a slave axis.

L is the speed of the slave axis.

21.22 **M series** ELECTRIC GEAR BOX AUTOMATIC PHASE SYNCHRONIZATION

When synchronization start or cancellation is specified, the EGB (Electric Gear Box) function does not immediately start or cancel synchronization. Instead, it performs acceleration or deceleration. Synchronization can be started or canceled without stopping the rotation of the spindle.

When synchronization starts, automatic phase matching is performed so that the position relative to the C-axis matches the position of the one-rotation signal on the spindle. This operation is similar to the operation at the beginning of synchronization by a one-rotation signal in hob synchronization with conventional functions for hobbing machine. Here, the spindle corresponds to the master axis of the EGB, and the workpiece axis corresponds to the slave axis of the EGB (the servo axis or Cs contour axis).

21.22.1 Acceleration/Decelerati on Type

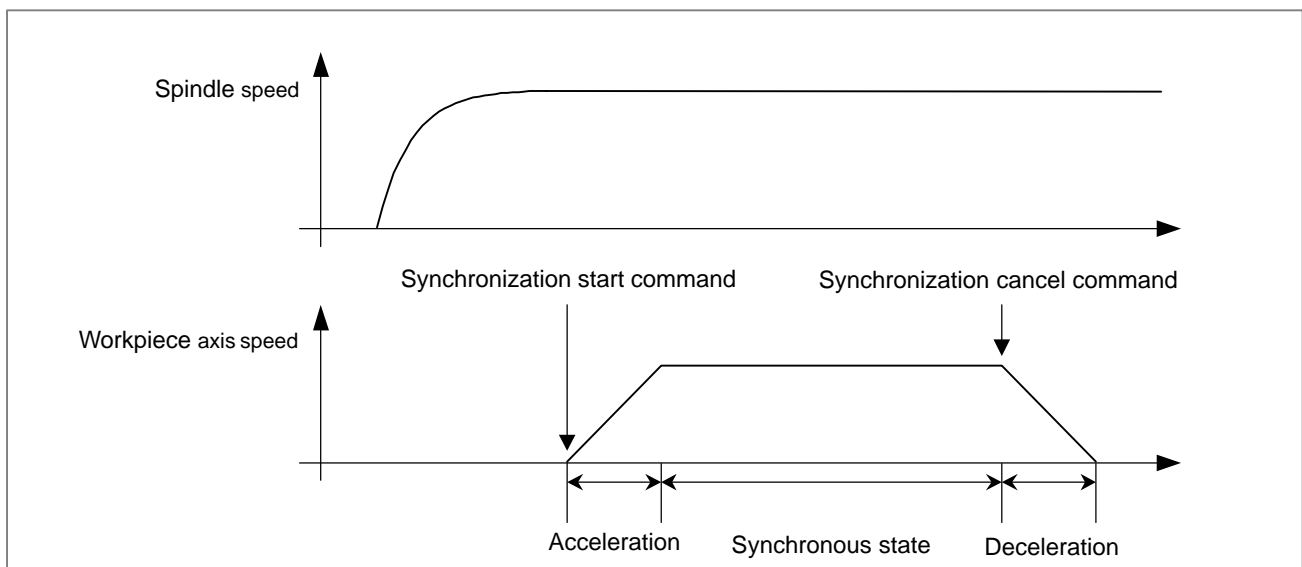

Format

G81 T_ L_ R1 ; Starting synchronization

T : Number of gear teeth
L : Number of hob threads

G80 R1 ; Canceling synchronization

21.22.2 Acceleration/Deceleration and Automatic Phase Synchronization

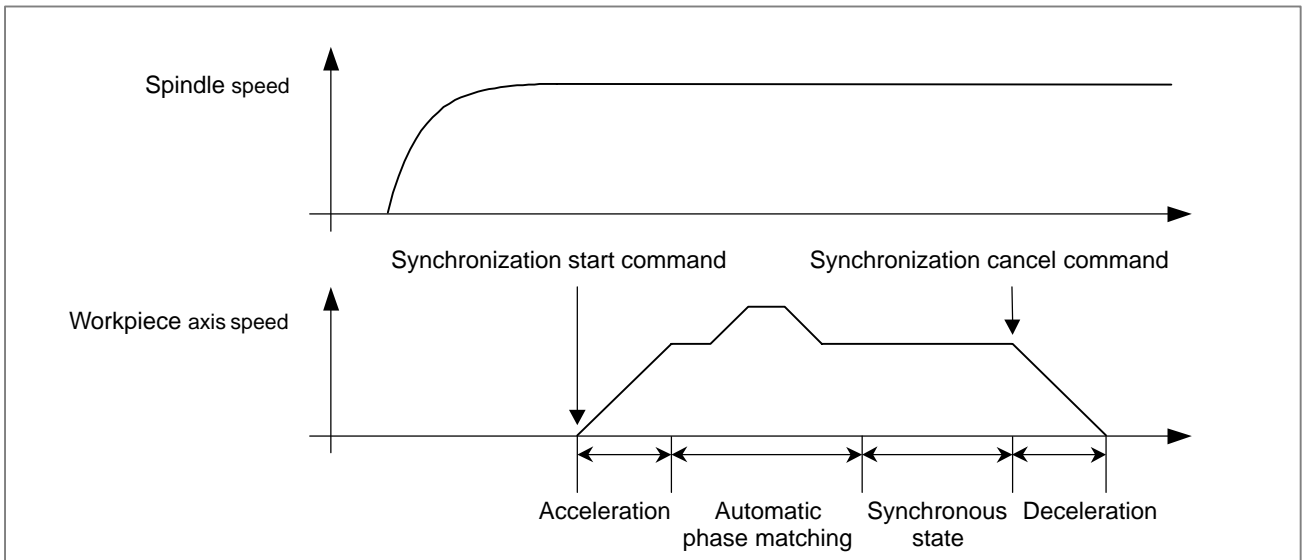

Format

G81 T_ L_ R2 ; Starting synchronization

T : Number of gear teeth
L : Number of hob threads

G80 R2 ; Canceling synchronization

21.23 **M series** SPINDLE ELECTRIC GEAR BOX

When one of two spindles is used as a tool axis, and the other is used as a workpiece axis, the rotation of the workpiece axis can be synchronized with the rotation of the tool axis (a grinding wheel or gear hob) to machine (grind or cut) gears.

For synchronization of these two spindles, the spindle electric gear box (EGB) function is used. In the spindle EGB, the motor control generates synchronization pulses based on feedback pulses from the position detector mounted on the tool axis (the master axis). According to the generated pulses, the workpiece axis (the slave axis) rotates. The feedback pulses are transferred from the master to slave through inter-amplifier communication.

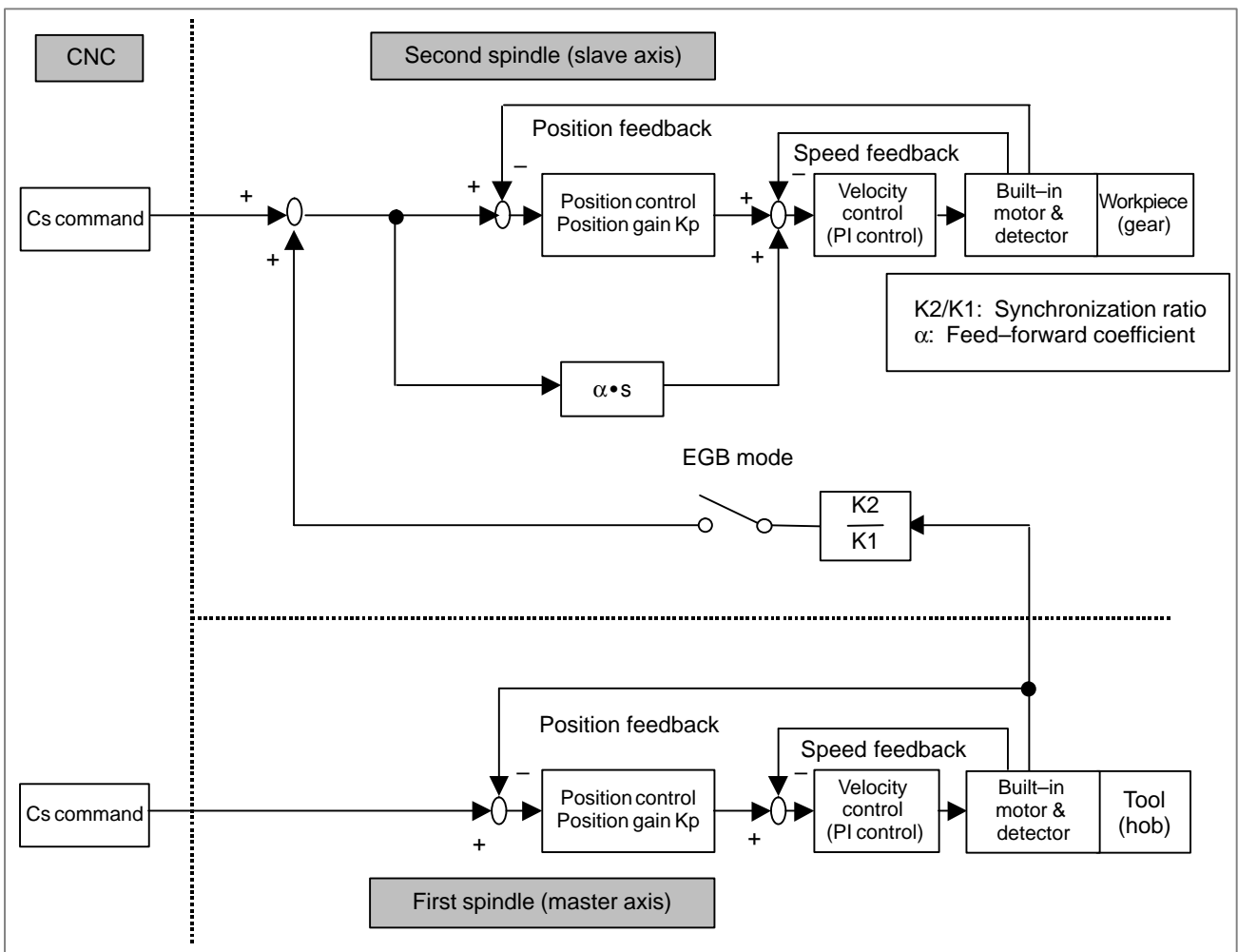

Format

G81 T_ L_ Q_ P_ ; Starts synchronization.

T : Number of teeth

L : Number of hob threads

Q : Module or diametral pitch

Specify a module in the case of metric input.

Specify a diametral pitch in the case of inch input.

P : Gear helix angle

G80 ; Cancels synchronization.

21.24 **M series**
FLEXIBLE
SYNCHRONIZATION
CONTROL FUNCTION

This function applies to hobbing machines and other machines that require synchronization of multiple sets of axes with various gear ratios. This function allows up to four individual sets to be synchronized independently. This can implement features specific to the hobbing machine such as synchronization between hobbing axis and a workpiece axis, Z-C synchronization in helical gear cutting, and Y-C synchronization in hobbing axis shift.

The specifications of flexible synchronization control are as follows:

- 1) The master axis number, slave axis number, and gear ratio are set in parameters.
- 2) There are four groups of these parameters. Synchronization of four groups can be performed at the same time.
- 3) For multiple master axes, one slave axis can also be specified.
- 4) Synchronization is started and canceled by DI signals from the PMC. When DI signal switching is to be made during automatic operation, a parameter-set M code must be used.
- 5) The two Cs axes can also be used as a master axis and slave axis.
- 6) Like the hobbing function, retraction is also possible.
- 7) Feedback pulses of the spindle operating as the Cs axis can be used for feed per revolution.

The command format is G95P_;, where P_; is the axis number of Cs axis.

NOTE
 This function is included in the threading and synchronous feed option.

Block diagram

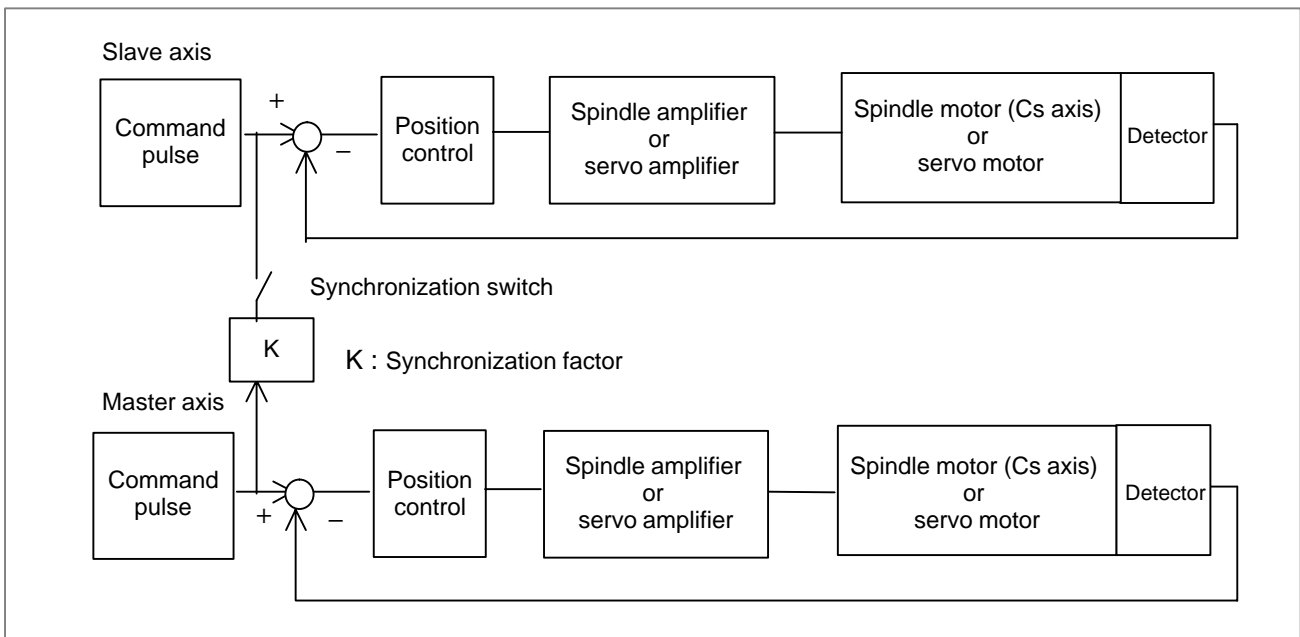

21.25 TEMPORARY ABSOLUTE COORDINATE SETTING

In a closed loop system equipped with a built-in absolute position detector (serial pulse coder) and incremental linear scale, a coordinate system is established at power-up by using absolute position data from the built-in absolute position detector. The subsequent position control is performed using incremental data of the linear scale. Since the position immediately after power-up is a temporary position, manual reference position return is needed to obtain a correct position.

When this function is used, a stroke limit check is enabled even before reference position return, although the position at power-up is an approximate position. Note that this function does not use the incremental linear scale as an absolute position detector.

This function is optional.

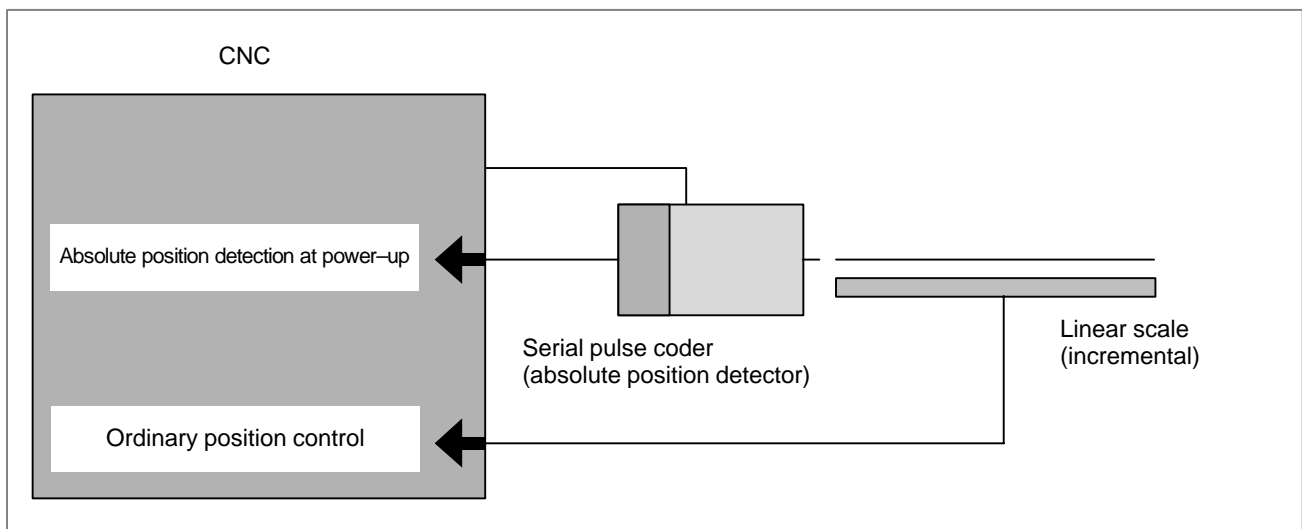
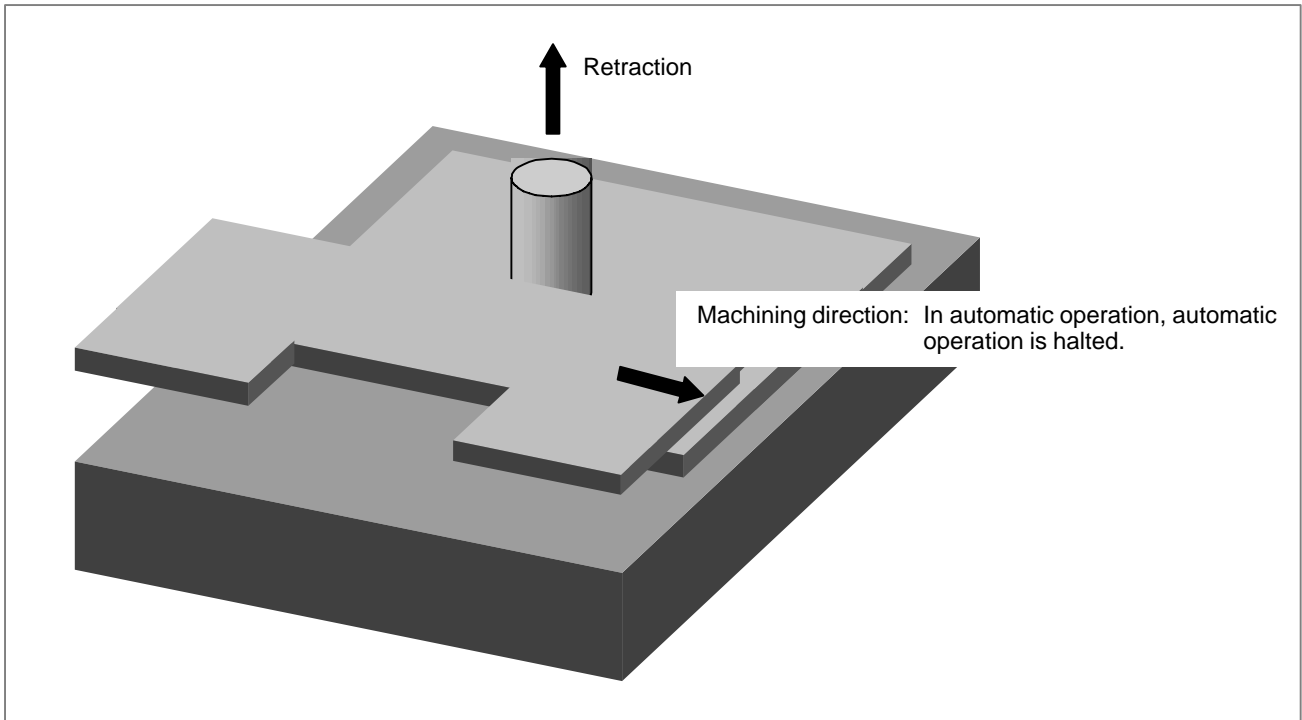

Fig. 21.25 System using the temporary coordinate setting function

21.26 GENERAL-PURPOSE RETRACTION

When the retract signal is driven to 1 in automatic operation mode or manual operation mode, the tool can be moved (retracted) along a parameter-set axis by a parameter-set amount on the rising edge of the signal. Upon completion of the retraction, the retract completion signal is output. This function is used to perform retraction to prevent the tool or workpiece from being damaged when an abnormality occurs during machining.



22

FUNCTIONS SPECIFIC TO 2-PATH CONTROL

Two paths can be independently controlled to cut the workpiece simultaneously.

- **Application to a lathe with one spindle and two tool posts (T series)**

Two tool posts can operate simultaneously to machine one workpiece attached to the spindle.

For example, while one tool post performs external machining, the other path can perform internal machining. The machining time is then reduced greatly.

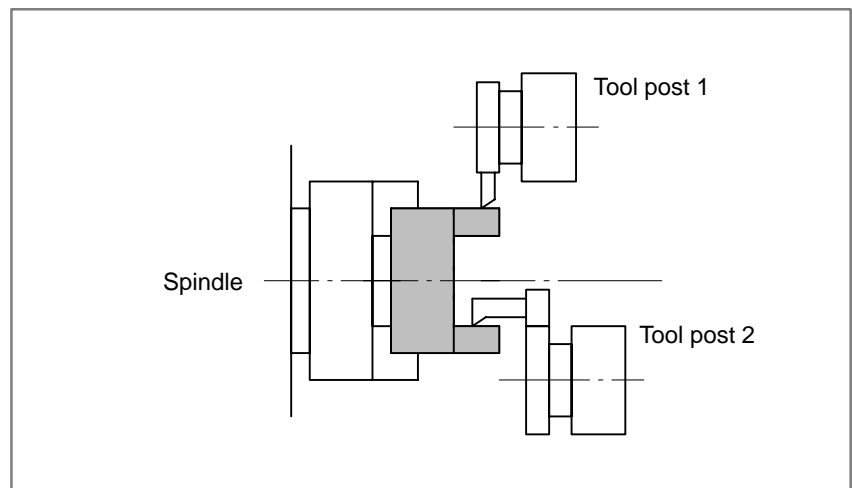

- **Application to a lathe with two spindles and two tool posts (T series)**

Two tool posts can operate simultaneously to machine two workpieces attached to two spindles. Since each tool post operates independently, the productivity is improved as if two lathes were used simultaneously.

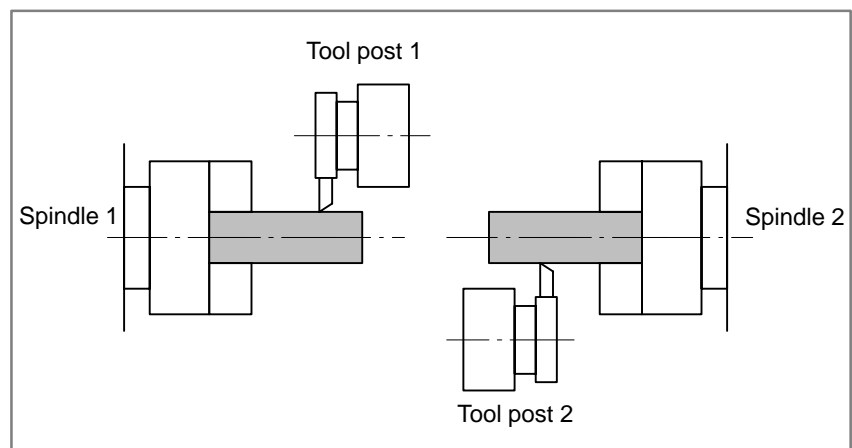

- **Application to transfer line (M series)**

A single CNC can independently control two machining centers mounted on both sides of the transfer line.

Application to transfer line (M series)

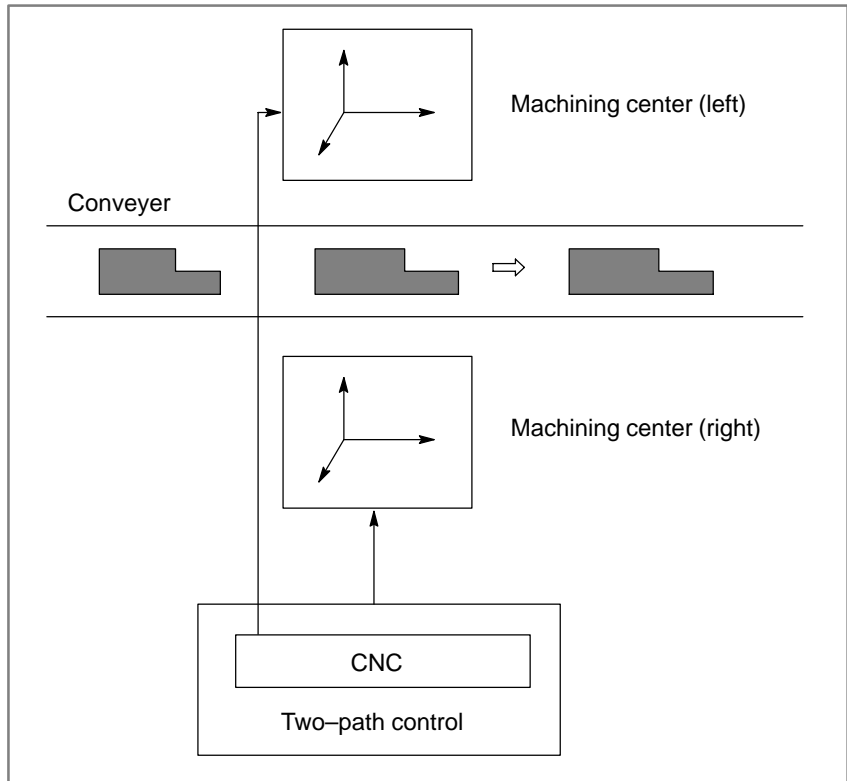

- **Controlling two paths simultaneously and independently**

The movement of each path is separately programmed and stored in the program memory for path. In automatic operation, this function selects the program for path 1 and that for path 2 from the program memory. When the paths are activated, the selected programs are executed simultaneously and independently. To make paths 1 and 2 synchronous during machining, the synchronization function (Section 22.1) can be used.

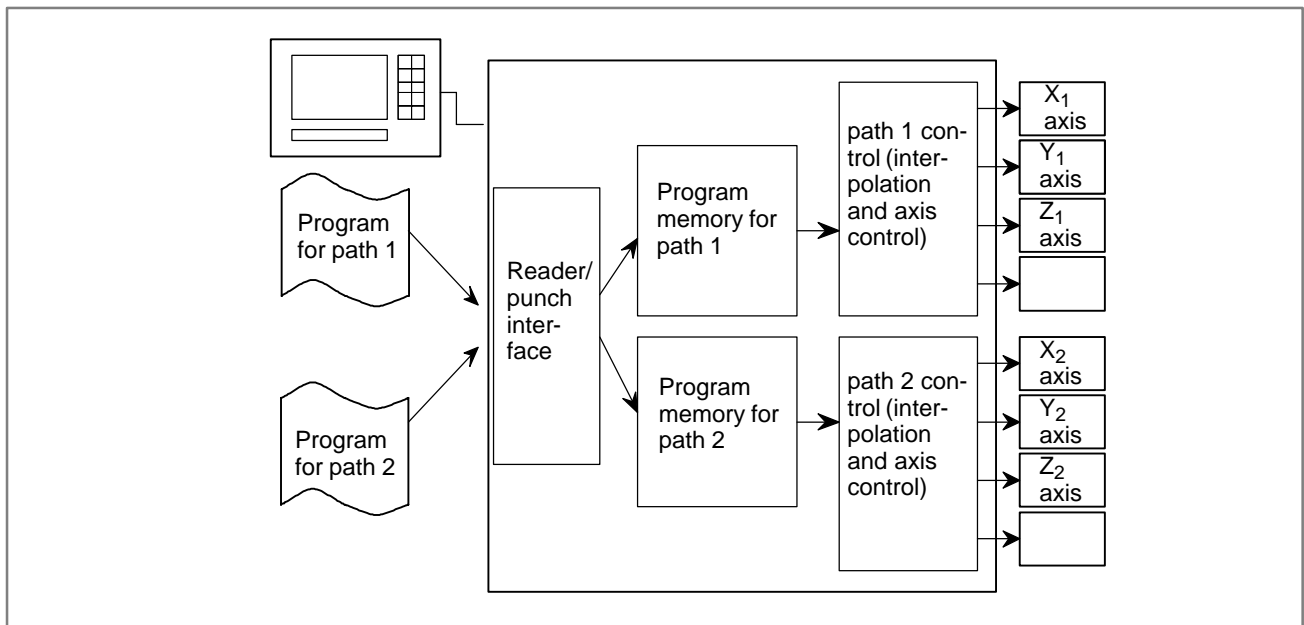

Only one MDI panel is provided for two paths. The path selection signal is used to switch the panel operation or display between paths 1 and 2.

22.1 WAITING FUNCTION

The M code controls the timing of paths 1 and 2 during machining. When the synchronization M code is specified in the machining program of each path, the paths are synchronized at the specified block. During automatic operation, if the synchronization M code is specified at one path, the path waits until the same M code is specified at the other path. After that, the next block is executed.

The range of the synchronization M codes to be used is set in a parameter beforehand.

Example) The synchronization M codes are M100 to M300.

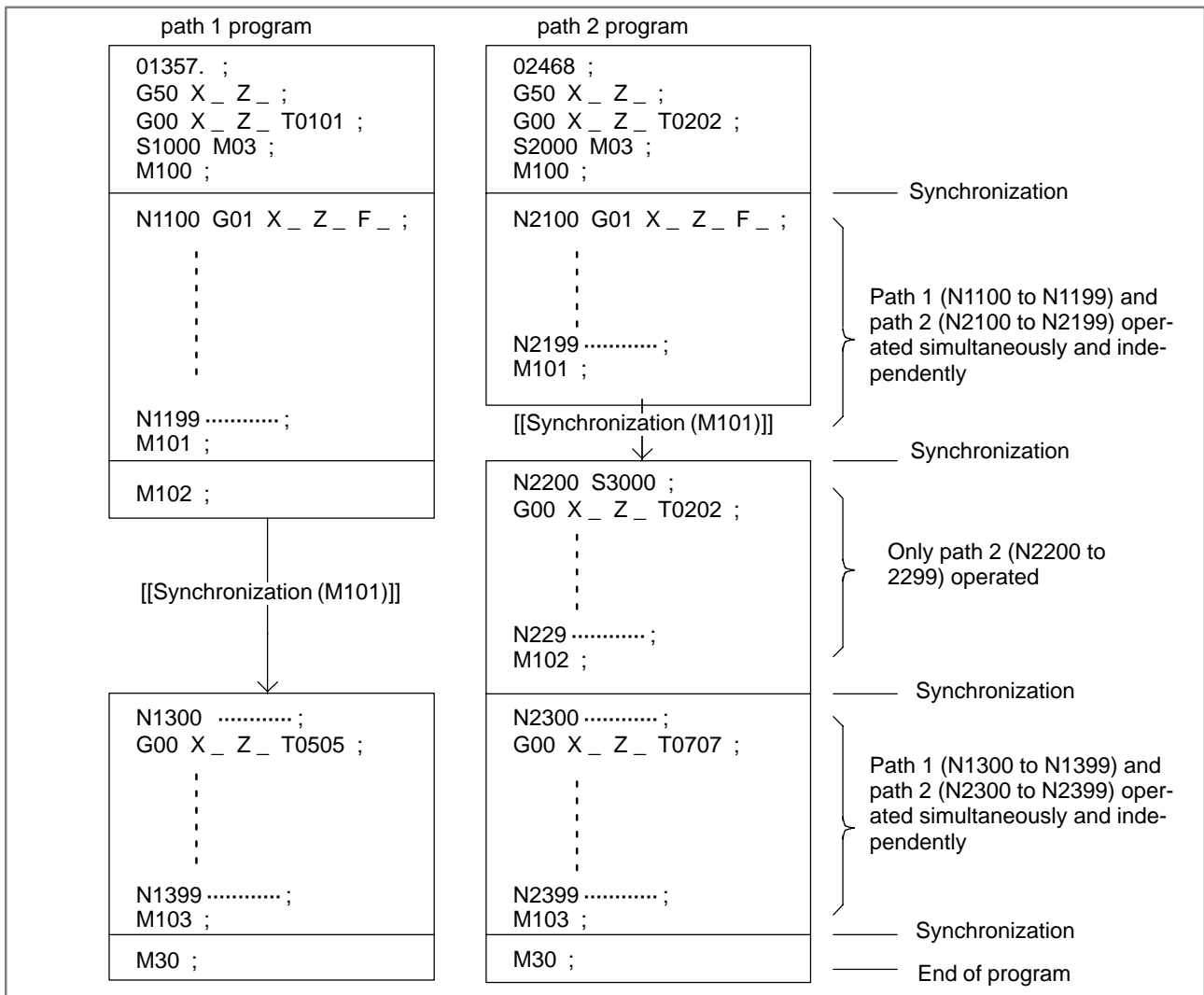

NOTE

- 1 While a path is waiting because of a synchronization M code, if a different synchronization M code is specified from the other path, an alarm occurs. Both paths, then stop operating.
- 2 Unlike other M codes, the code signal and strobe signal are not output for the synchronization M code.
- 3 The synchronization signal is output from the path which is waiting.
- 4 The synchronization-ignore signal can be used to ignore the synchronization M code specified in the machining program. This signal is used when only one path is used for machining.

22.2 TOOL POST INTERFERENCE CHECK

T series

When one workpiece is machined by two tool posts operating simultaneously, paths may come close to each other. If these tool posts touch each other because of a program error or setting error, the tool or even the machine may be damaged.

If such an accident is expected, the tool post interference check function decelerates and stops the paths.

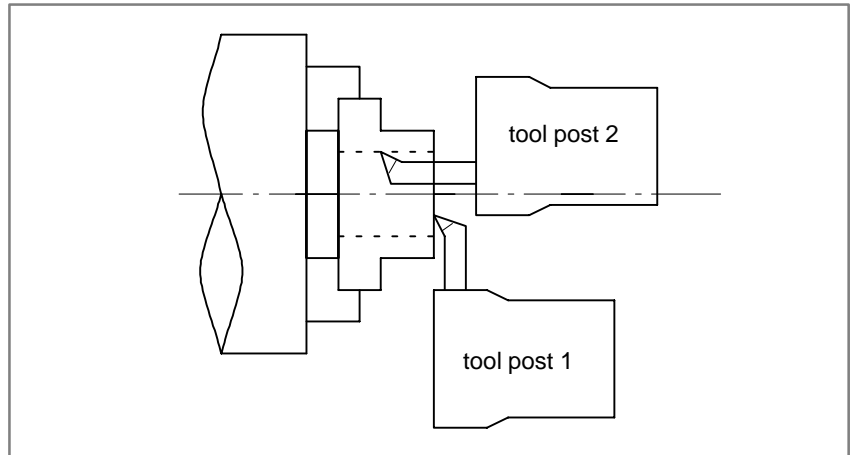

To execute the tool post interference check, the contour of each tool post (contour including the tool mounted on the path) must be set as a contact-inhibited area for each tool beforehand.

This function checks if the contact-inhibited areas of these tool posts overlap. If they overlap each other, it determines that the tool posts have interfered with each other, and decelerates them till they stop as an alarm.

CAUTION

For this function, up to 64 tool offsets can be displayed or set as tool figure data (contact-inhibited areas).

22.3 BALANCE CUT (G68, G69)

T series

To machine a fine workpiece, two cutting tools should be applied on both sides of a workpiece as shown below. When only one tool is applied, the other side of the workpiece may be deflected. Using two cutting tools can make machining precision higher. If, however, these tools are not moved synchronously, the workpiece will shake and machining will not be done precisely. The balance cut function makes paths move synchronously.

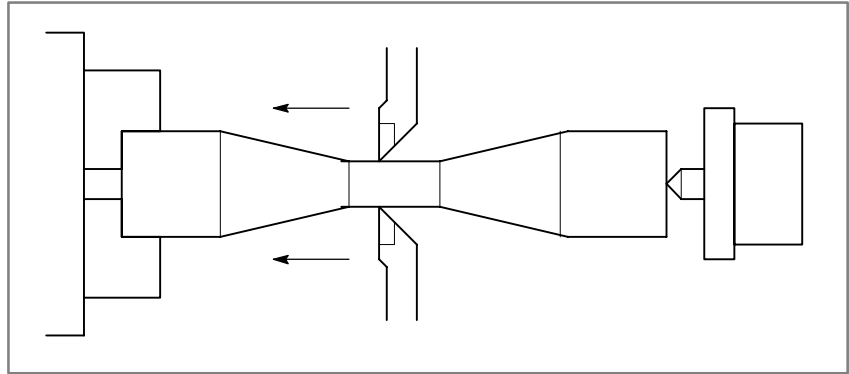

NOTE

The balance cut function cannot be used if the option of mirror-image operation of facing paths is specified.

22.4 MEMORY COMMON TO PATHS

- Custom macro common variables
- Tool compensation memory (T series)

A machine with two paths has different custom macro common variables and tool compensation memory areas for paths 1 and 2. Paths 1 and 2 can share the custom macro common variables and tool compensation memory areas provided certain parameters are specified accordingly.

Paths 1 and 2 can share all or part of custom macro common variables #100 to #149 and #500 to #531, provided parameters are specified accordingly. (The data for the shared variables can be written or read from either path.)

Path 2 can reference or specify the data in the tool compensation memory area of path 1, provided the parameter is specified accordingly. This can be executed only when paths 1 and 2 have identical data for tool compensation (number of groups, number of columns, unit system, etc.).

22.5 AXIS RECOMPOSITION

T series

At two-path control, usually the axes belonging to tool post 1 (X_1, Z_1, \dots) are moved by the move command of tool post 1. The axes belonging to tool post 2 (X_2, Z_2, \dots) are moved by that of tool post 2 (individual path control). The synchronization/mix control function can move an optional axis of one tool post and that of the other tool post synchronously (synchronization control). This control function can exchange the move commands for optional axes between two tool posts (mix control).

Explanations

- **Individual tool post control**

The axes belonging to tool post 1 (X_1, Z_1, \dots) are moved by the move command of tool post 1. The axes belonging to tool post 2 (X_2, Z_2, \dots) are moved by that of tool post 2.

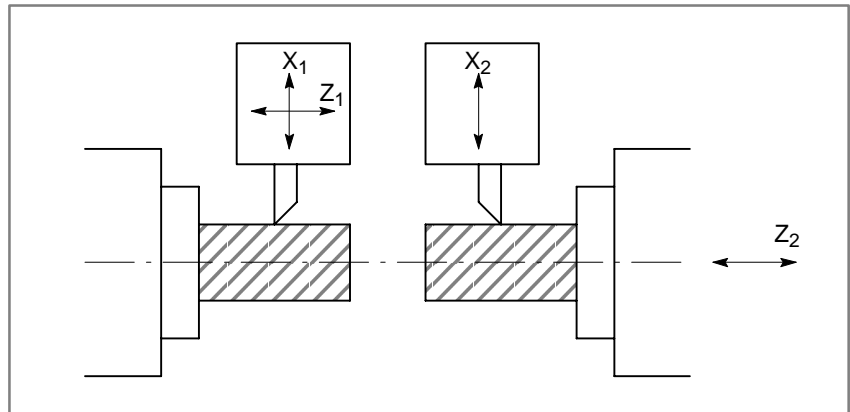

- **Synchronization control**

The move command for an axis (master axis) is given also to another optional axis (slave axis). These two axes are then moved synchronously. The slave axis can be moved also by its own move command. Which command to use can be selected by the synchronization control selection signal from PMC.

CAUTION

- 1 Synchronization here means issuing the master axis move command to the master axis and also to the slave axis simultaneously. The position deviation of master and slave axes is always detected. It, however, is not compensated because synchronization compensation is not performed. If a deviation exceeding the limit set in the parameter is detected, an alarm occurs and the movements of both axes are stopped.
- 2 The master axis and slave axis do not need to belong to the same tool post. Two or more slave axes can be specified for one master axis.

Example 1)

The Z_2 axis is synchronized with the Z_1 axis (machining with both ends of a workpiece being held).

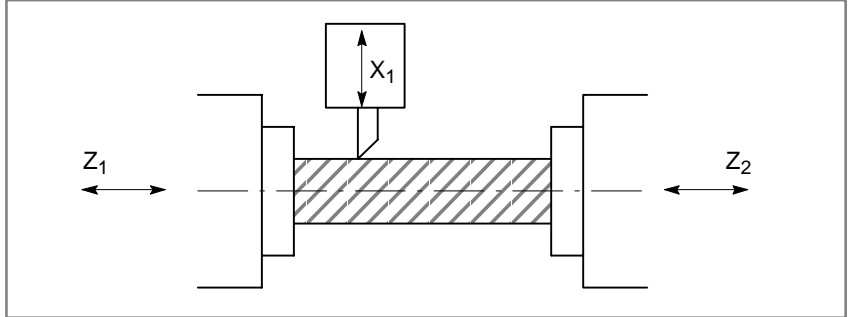

Example 2)

The X_2 and Z_2 axes are synchronized with the X_1 and Z_1 axes (balance cut).

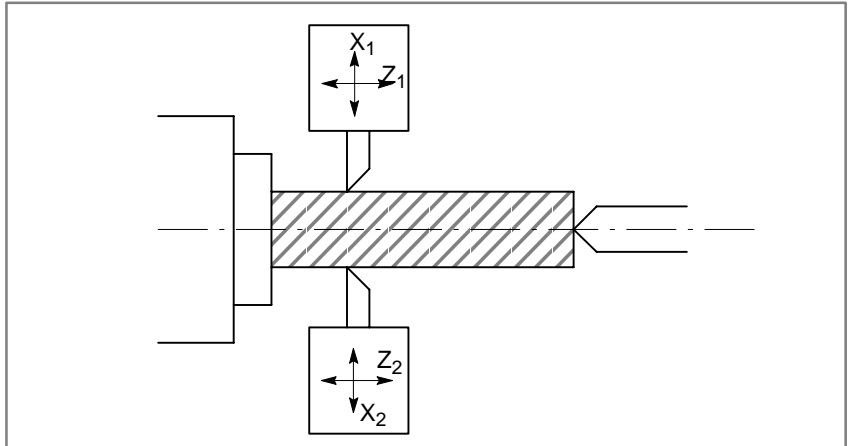

• Mixture control

When moving axes, the move commands for optional axes can be exchanged between two tool posts.

Example 1)

The move commands for X_1 and X_2 axes are exchanged.

The program command of tool post 1 moves X_2 and Z_1 axes.

The program command of tool post 2 moves X_1 and Z_2 axes.

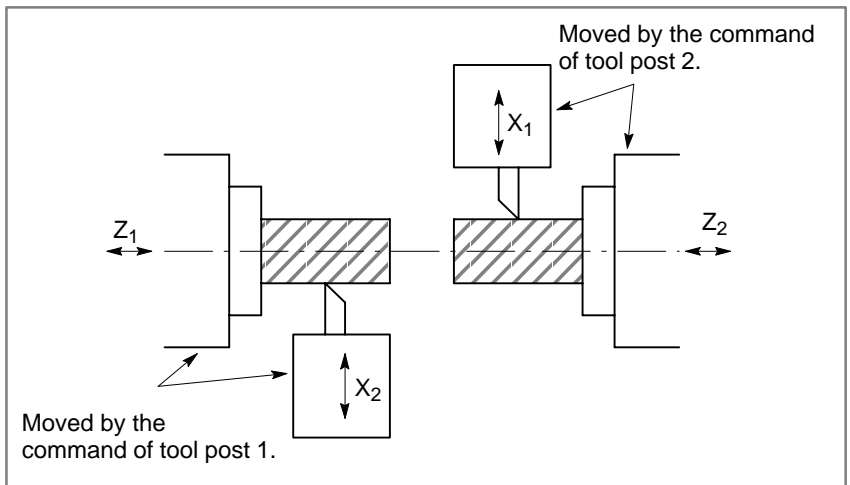

22.6 COPYING A PROGRAM BETWEEN TWO PATHS

In a CNC supporting two-path control, specified machining programs can be copied between the two paths by setting a parameter accordingly. A copy operation can be performed by specifying either a single program or a range.

- Single-program copy

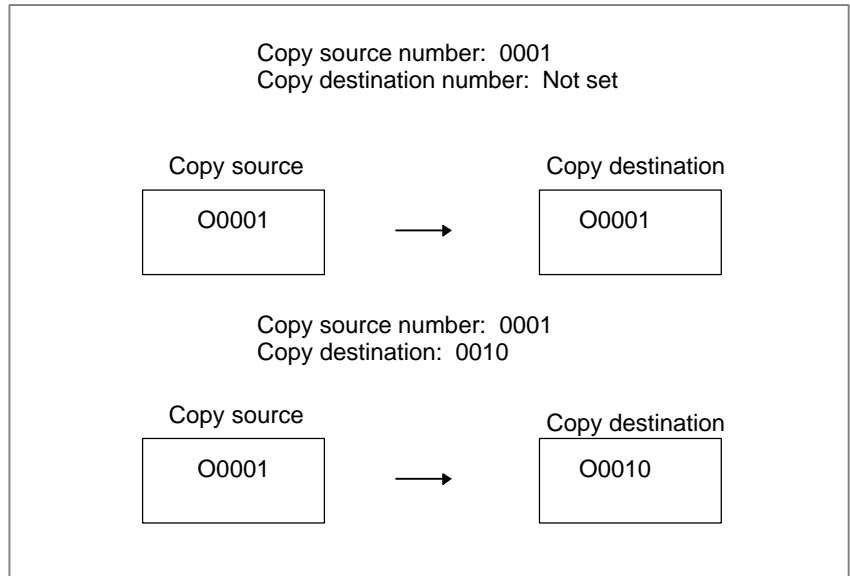

- Specified-range copy

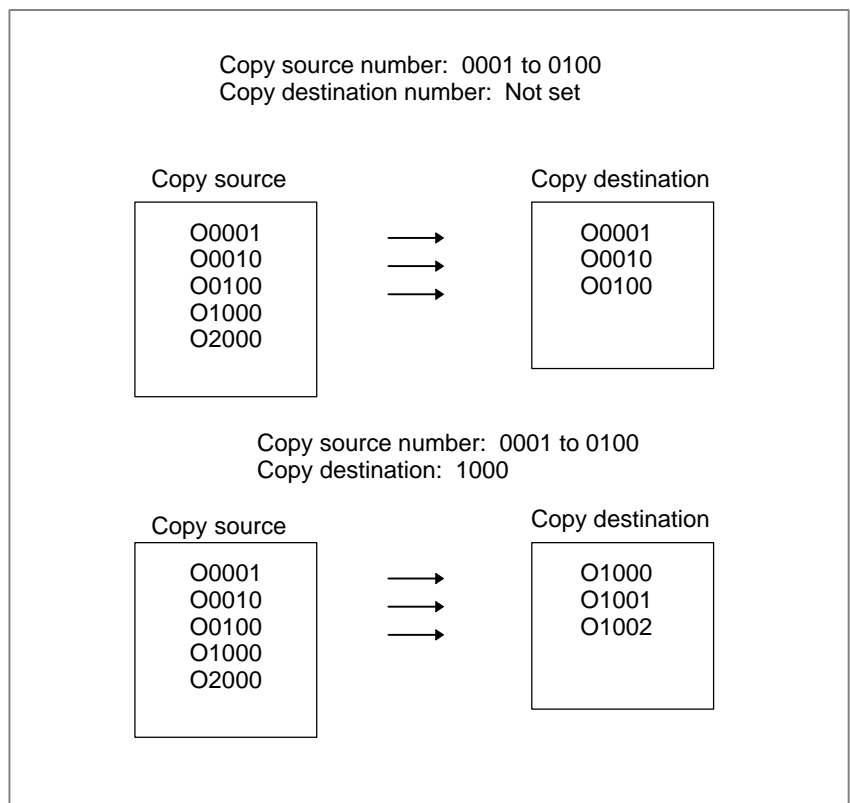

23

MANUAL OPERATION



23.1 JOG FEED

- **Jog feed**

Each axis can be moved in the + or - direction for the time the button is pressed. Feed rate is the parameter set speed with override of:

0 - 655.34%, 0.01% step.

The parameter set speed can be set to each axis.

- **Manual rapid feed**

Each axis can be fed in a rapid feed to the + or - direction for the time the button is pressed.

Rapid traverse override is also possible.

23.2 INCREMENTAL FEED

Specified move amount can be positioned to the + or - direction with the button.

Move amount of:

(least command increment) x (magnification)

can be specified. The feed rate is that of manual feed.

The possible magnifications to be specified are as follows.

×1, ×10, ×100, ×1000.

Increment system	Metric input	Inch input
IS-B	0.001, 0.01, 0.1, 1.0	0.0001, 0.001, 0.01, 0.1
IS-C	0.0001, 0.001, 0.01, 0.1	0.00001, 0.0001, 0.001, 0.01

23.3 MANUAL HANDLE FEED (1ST)

By rotating the manual pulse generator, the axis can be moved for the equivalent distance. Manual handle feed is controlled 1 axis at a time. The manual pulse generator generates 100 pulses per rotation. Move amount per pulse can be specified from the following magnifications:

×1, ×10, ×M, ×N.

N is parameter set values of 0 - 1000. M is parameter set values of 1-127.

Move distance is :

(Least command increment) x (magnification)

Increment system	Metric input	Inch input
IS-B	0.001, 0.01, M/1000, N/1000 mm	0.0001, 0.001, M/10000, N/10000 inch
IS-C	0.0001, 0.001, M/10000, N/1000 mm	0.00001, 0.0001, M/100000, N/100000 inch

23.4 MANUAL HANDLE FEED (2ND, 3RD) (T SERIES: 2ND)

A 2nd, as well as 3rd manual pulse generator can be rotated to move the axis for the equivalent distance. Manual handle feed of 3 axes (for T system, 2 axes) can be done at a time. Multiplier is common to 1st, 2nd and 3rd manual pulse generators.

23.5 HANDLE FEED IN THE SAME MODE AS FOR JOG FEED

Although manual handle feed is usually enabled only in the manual handle-feed mode, it can also be performed in the manual continuous-feed mode by setting the corresponding parameters. However, manual continuous-feed and manual handle-feed cannot be performed simultaneously. Manual handle-feed can be performed only when manual continuous-feed is in progress (i.e., an axis is moving).

23.6 **T series** MANUAL PER-ROTATION FEED

The feedrates in jog feed and incremental feed can be specified by inputting either feed distance per minute or feed distance per rotation.

- 1 Specification of feed distance per minute or feed distance per rotation is selected by setting the corresponding parameter.
- 2 During manual rapid traverse, feed distance per minute is always specified.

23.7 MANUAL ABSOLUTE ON/OFF

When tool is moved by manual operation, whether to add the move distance to the absolute coordinate value in the workpiece coordinate system is selected depending on the input signal *ABSM.

When tool is moved by manual operation when *ABSM is set to 0, the move distance is added to the absolute coordinate value.

When tool is moved by manual operation when *ABSM is set to 1, the move distance is ignored, and is not added to the absolute coordinate value. In this case, the work coordinates is shifted for the amount tool was moved by manual operation.

23.8 **M series**
TOOL AXIS
DIRECTION HANDLE
FEED AND TOOL AXIS
DIRECTION HANDLE
FEED B

The tool axis direction handle feed function allows the tool to be moved a specified distance by handle feed, along the axis of the tool, tilted by rotating the rotation axes.

Tool axis direction handle feed function B provides two functions: handle feed along the tool axis and that perpendicular to the tool axis.

These functions are used for applications such as 5-axis diesinking machining.

23.8.1
Tool Axis Direction
Handle Feed

When the tool axis direction handle mode is selected and the manual pulse generator is rotated, the tool is moved by the specified travel distance in the direction of the tool axis tilted by the rotation of the rotary axis.

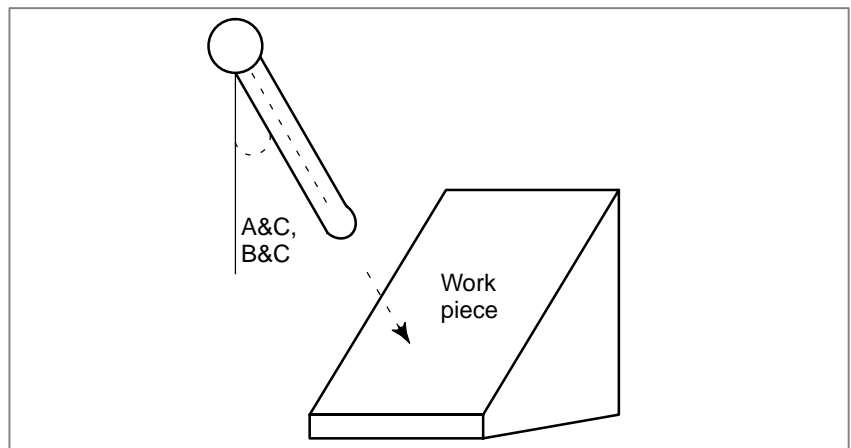

23.8.2
Tool Axis Normal
Direction Handle Feed

When the tool axis normal direction handle mode is selected and the manual pulse generator is rotated, the tool is moved by the specified travel distance in the direction normal to the tool axis tilted by the rotation of the rotary axis.

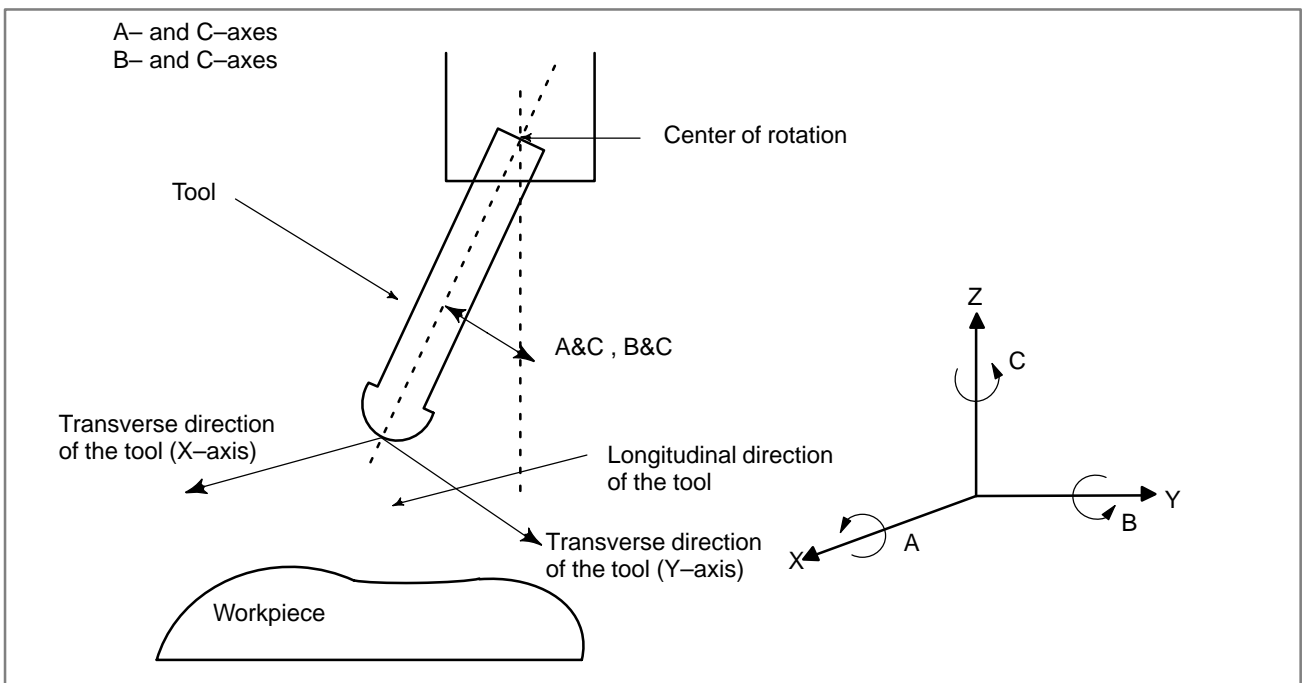

23.9 MANUAL LINEAR/CIRCULAR INTERPOLATION (ONLY AT 1-PATH CONTROL)

In manual handle feed or jog feed, the following types of feed operations are enabled in addition to the feed operation along a specified single axis (X-axis, Y-axis, Z-axis, and so forth) based on simultaneous 1-axis control:

- Feed along a tilted straight line in the XY plane (M series) (linear feed) or in the ZX plane (T series) (linear feed) based on simultaneous 2-axis control
- Feed along a circle in the XY plane (M series) (circular feed) or in the ZX plane (T series) (circular feed) based on simultaneous 2-axis control

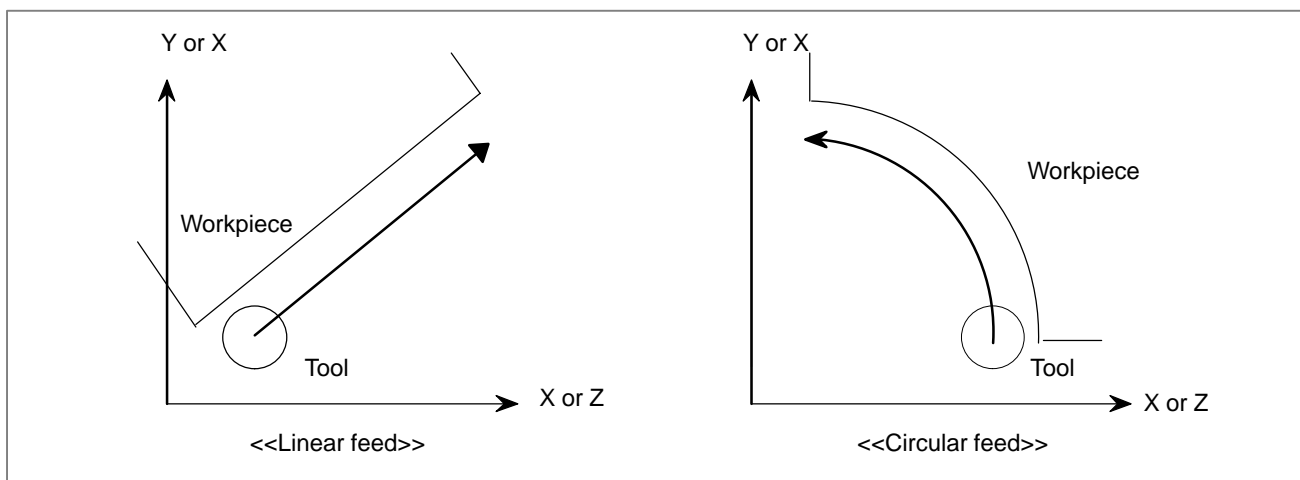

23.10 **M series** RIGID TAPPING BY MANUAL HANDLE FEED

Once the CNC is put in the rigid tapping mode by issuing a program instruction in the MDI mode, moving the tapping axis with the manual handle in the handle mode can cause rigid tapping to be performed.

Manual rigid tapping is available when parameter is set.

The program instruction is necessary to determine the lead of a screw to be produced and enable the rigid tapping mode.

The program instruction must always specify a tapping axis. However, a value specified in it must not cause the tapping axis to operate. Do not specify an instruction for positioning to the position where a hole to be made or to the R point; otherwise axis movement occurs.

(Example program)

```
M29 S1000;
G91 G84 Z0 F1000 ;
```

The spindle rotation direction for manual rigid tapping depends on the specified tapping cycle G code and parameter.

23.11 MANUAL NUMERIC COMMAND

The manual numeric command function allows data programmed through the MDI to be executed in jog mode. Whenever the system is ready for jog feed, a manual numeric command can be executed. The following eight functions are supported:

- (1) Positioning (G00)
- (2) Linear interpolation (G01)
- (3) Automatic reference position return (G28)
- (4) 2nd/3rd/4th reference position return (G30)
- (5) M codes (miscellaneous functions)
- (6) S codes (spindle functions)
- (7) T codes (tool functions) (M series)
- (8) B codes (second auxiliary functions)

By setting the corresponding parameters, the following commands for axial motion and the M, S, T, and B functions can be disabled:

- (1) Positioning (G00)
- (2) Linear interpolation (G01)
- (3) Automatic reference position return (G28)
- (4) 2nd/3rd/4th reference position return (G30)
- (5) M codes (miscellaneous functions)
- (6) S codes (spindle functions)
- (7) T codes (tool functions) (M series)
- (8) B codes (second auxiliary functions)

23.12 T series THE STOP POSITION SETTING WITH THE MANUAL FEED

At the end of manual feed or manual rapid traverse, this function carries out feed until absolute coordinates are automatically set to rounded values (based on the unit of stop accuracy). The unit of stop accuracy is specified by a relevant signal.

In jog feed mode or teach in jog mode, this function starts on the falling edge of a feed axis direction select signal (+J1 to +J8, -J8 to -J8), but does not start in any of the conditions below.

- Operation has been suspended due to a reset.
- Operation has been suspended due to an emergency stop.
- The mode has been changed.
- An alarm has been generated (the function is disabled while the alarm persists).
- A jog override has been set to 0%.
- An interlock has been applied (see also CAUTION).
- The system is in manual reference position return mode (REF).
- The axis is currently subjected to three-dimensional coordinate conversion.

24

AUTOMATIC OPERATION



24.1 OPERATION MODE

24.1.1 DNC Operation

The part program can be read and executed block by block from the input device connected to the reader/puncher interface.

24.1.2 Memory Operation

Program registered in the memory can be executed.

24.1.3 MDI Operation

Multiple blocks can be input and executed by the MDI unit.

24.2 SELECTION OF EXECUTION PROGRAMS

24.2.1 Program Number Search

Program number currently in need can be searched from the programs registered in memory operating the MDI.

24.2.2 Sequence Number Search

The sequence number of the program on the currently selected memory can be searched using the MDI unit.
When executing the program from half-way (not from the head) of the program, specify the sequence number of the half-way program, and the program can be executed from the half-way block by sequence number search.

24.2.3 Rewind

After program execution has ended, the program in the memory or the tape reader can be reminded to the program head, with this reset & rewind signal on. (When a portable tape reader with reels is in use)

24.2.4 External Workpiece Number Search

By specifying work numbers of 01 - 15 externally (from the machine side, etc.), program corresponding to the work number can be selected.
The work number equals the program number. For example when work number 12 is specified, program, O0012 is selected.

24.2.5 Expanded External Workpiece Number Search

The external workpiece number search function has been expanded. A workpiece number 0001 to 9999 can be specified to select a program (O0001 to O9999) corresponding to the workpiece number.

24.3 ACTIVATION OF AUTOMATIC OPERATION

24.3.1 Cycle Start

Set operation mode to memory operation, MDI operation, or DNC operation, press the cycle start button, and automatic operation starts.

24.4 EXECUTION OF AUTOMATIC OPERATION

24.4.1 Buffer Register

Buffer register in CNC equivalent to one block is available for program read and control of CNC command operation intervals caused by preprocess time.

24.5 AUTOMATIC OPERATION STOP

24.5.1 Program Stop (M00, M01)

Automatic operation is stopped after executing the M00 (program stop) commanded block. When the optional stop switch on the operator's panel is turned on, the M01 (optional stop) commanded block is executed and the automatic operation stops.

The automatic operation can be restarted by the cycle start button.

24.5.2 Program End (M02, M30)

The CNC is reset after executing the M02 (end of program) or M30 (end of tape) commanded block.

24.5.3 Sequence Number Comparison and Stop

During program operation, when the block with a preset sequence number appears, operation stops after execution of the block, to a single block stop status. The sequence number can be set by the operator through the MDI panel. This function is useful for program check, etc., because program can be stopped at optional block without changing the program.

24.5.4 Feed Hold

The CNC can be brought to an automatic operation hold status by pressing the feed hold button on the operator's panel. When feed hold is commanded during motion, it decelerates to a stop.

Automatic operation can be restarted by the cycle start button.

24.5.5 **T series** Thread Cutting Cycle Retract

When feed hold is commanded during thread cutting cycle by G76 or G78, the tool rapidly retracts to the cycle start point, like in the final chamfering of the thread cutting cycle. Thread cutting cycle restarts by cycle start command.

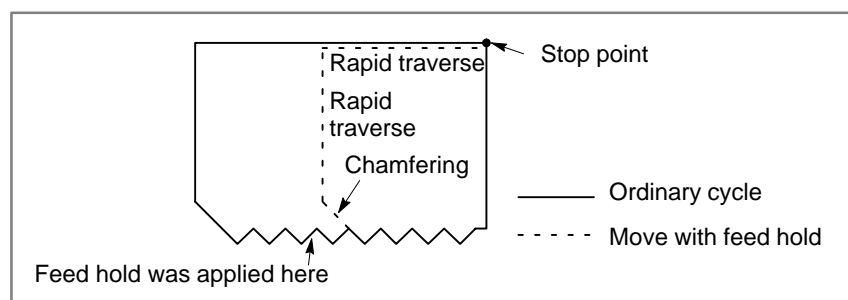

Without this function, if feed hold is commanded during thread cutting, it returns and stops at the position where thread cutting circle was started after thread cutting is ended.

24.5.6 Reset

The automatic operation can be ended in a reset status by the reset button on the MDI panel or by the external reset signal, etc. When reset is commanded during motion, it decelerates to a stop.

24.6 RESTART OF AUTOMATIC OPERATION

24.6.1 Program Restart

This function allows program restart by specifying the desired sequence number, for example after tool break and change, or when machining is restarted after holidays. The NC memorizes the modal status from the beginning of the program to the sequence number.

If there are M codes necessary to be output, output the M code by the MDI, press the start button, the tool automatically moves to the start position, and the program execution restarts.

24.6.2 Tool Retract & Recover

These functions are used for replacing tools damaged retraction of tools for confirming the cutting conditions, and recovering the tools efficiently to restart the cutting.

Also, the escape operation can be performed with the tool retract signal by previously setting the escape amount (position) with a program. This can be used for retraction for detecting tool damage.

- 1 Input the tool retract signal during executing the automatic operation. Then, the automatic operation is halted and the escape operation (retraction) is performed to the escape position commanded by the program.
- 2 Input the tool retract signal to initiate the retract mode.
- 3 After that, switch the automatic mode to the manual mode to move tools with manual operation such as the jog feed and handle feed. A maximum of 10 points can be automatically memorized as travel path.
- 4 Input the tool recovery signal to return the tool to the retraction position in the opposite direction along the path moved by manual operation automatically (recovery operation).
- 5 Perform the cycle start to return the tool to the position where the tool retract signal was entered (repositioning). When the recovery operation completes, the halted automatic operation resumes.

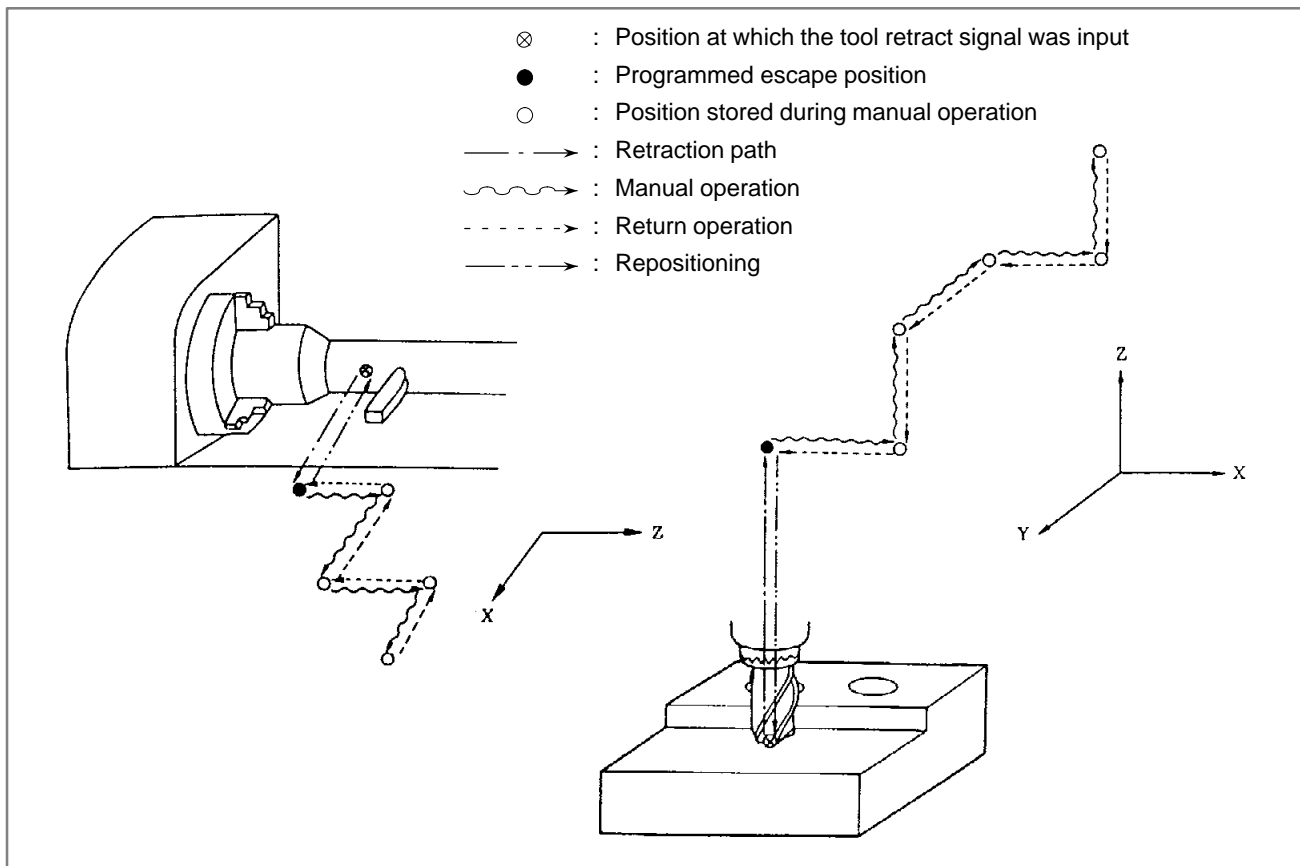

Command the escape amount using the G10.6.

G10.6 IP _ ;

The escape data sorted by G10.6 is valid until the next G10.6 is commanded. Command the following to cancel the escape amount:

G10.6 ; (Single command)

where

The G10.6 is the one-shot G code.

The tool can be retracted to a special location of work coordinate system when the escape amount is command by the ABSOLUTE (G90). When the escape amount is commanded by the INCREMENTAL (G91), the tool can retract by only the commanded escape amount.

24.6.3 Manual Intervention and Return

In cases such as when tool movement along an axis is stopped by feed hold during automatic operation so that manual intervention can be used to replace the tool: When automatic operation is restarted, this function returns the tool to the position where manual intervention was started. To use the conventional program restart function and tool withdrawal and return function, the switches on the operator's panel must be used in conjunction with the MDI keys. This function does not require such operations.

24.7 MANUAL INTERRUPTION DURING AUTOMATIC OPERATION

24.7.1 Manual Handle Interruption

During automatic operation, tool can be adjusted by the manual pulse generator without changing the mode. The pulse from the manual pulse generator is added to the automatic operation command and the tool is moved for the recommended pulses.

The work coordinate system thereafter is shifted for the pulse commanded value. Movement commanded by handle interruption can be displayed.

24.8 SCHEDULING FUNCTION

Any of the files (programs) stored on a FANUC Handy File, a FANUC Program File Mate, a FANUC FLOPPY CASSETTE can be selected and executed.

- A list of the files stored on the Floppy Cassette can be displayed.
- Files can be executed in an arbitrary order and executed an arbitrary number of times by specifying file numbers in a desired order along with their repeat counts.

File list screen

```

FILE DIRECTORY                                F0004 N00020
CURRENT SELECTED:O0002
  NO.  FILE NAME                (METER)  VOL
0000  SCHEDULE
0001  PARAMETER                    46.1
0002  ALL.PROGRAM                  12.3
0003  O0001                        1.9
0004  O0002                        1.9
0005  O0003                        1.9
0006  O0004                        1.9
0007  O0005                        1.9
0008  O0010                        1.9

RMT **** * 09:36:48
[ SELECT ][           ][           ][           ]

```

Schedule screen (for specifying file numbers and repeat counts)

```

FILE DIRECTORY                                F0000 N00020
ORDER  FILE NO.                REQ.REP  CUR.REP
 01    0001                      2        0
 02    0007                      25       0
 03    0008                       6        0
 04    0011                     9999       0
 05    0012                      LOOP       0
 06
 07
 08
 09
 10

>_
RMT **** * 09:36:48
[ PRGRM ][           ][ DIR  ][ SCHEDUL ][ (OPRT) ]

```

24.9 **M series** SIMULTANEOUS INPUT AND OUTPUT OPERATIONS (ONLY AT 1-PATH CONTROL)

While a tape is running, a program input from an I/O device connected to the reader/punch interface can be executed and stored in memory. Similarly, a program stored in memory can be executed and output through the reader/punch interface at the same time.

24.10 **M series** RETRACE FUNCTION

With the retrace function, the tool can be moved in the reverse direction (reverse movement) by using the REVERSE switch during automatic operation to trace the programmed path. The retrace function also enables the user to move the tool in the forward direction again (forward return movement) along the retraced path until the retrace start position is reached. When the tool reaches the retrace start position, the tool resumes movement according to the program.

24.11 RIGID TAPPING RETURN

M series

When rigid tapping is stopped, either by an emergency stop or by a reset, the tap may cut into the workpiece. The tap can subsequently be drawn out by using a PMC signal. This function automatically stores information relating to the tapping executed most recently. When a tap return signal is input, only the rigid tapping cycle return operation is executed, based on the stored information. The tap is pulled toward the R point. When a return value α is set in a corresponding parameter, the pulling distance can be increased by α .

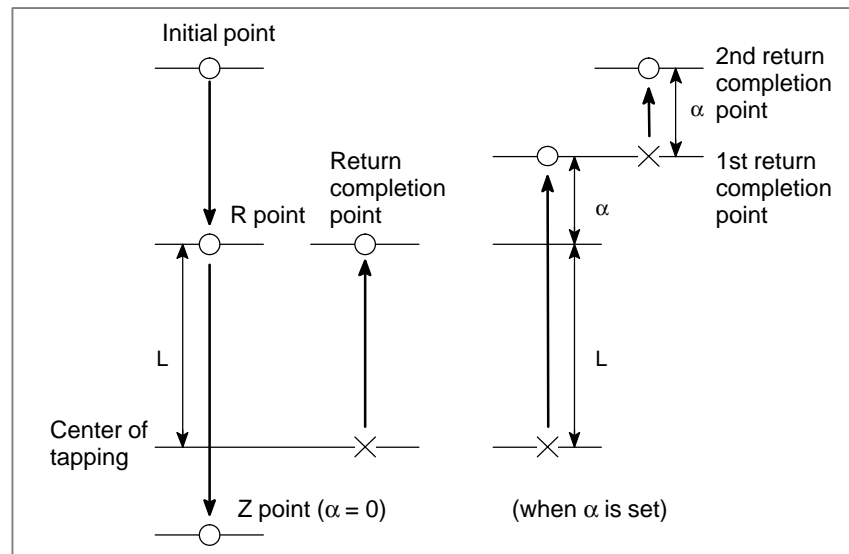

24.11.1 Rigid Tapping Return by Specifying G30

Instead of signal input, a G30 command can be used to start rigid tapping return. This is made possible by parameter setting.

Format

G30 P99 M29 S_ ;

M29 : A parameter-set M code that specifies rigid tapping
S_ : Specify S used when rigid tapping is specified. (Optional)

NOTE

- 1 When use of G30 is selected, rigid tapping return cannot be performed by signal input.
- 2 The rigid tapping return command is a one-shot command.

25 PROGRAM TEST FUNCTIONS



25.1 ALL-AXES MACHINE LOCK

In machine lock condition, the machine does not move, but the position display is updated as if the machine were moving. Machine lock is valid even in the middle of a block.

25.2 MACHINE LOCK ON EACH AXIS

Machine lock can be commanded per axis.

25.3 AUXILIARY FUNCTION LOCK

This function inhibits transmitting of M, S, T, B function code signals and strobe signals to PMC. Miscellaneous functions M00, M01, M02, and M30 are executed even when miscellaneous function lock is applied, allowing the code signal, strobe signal, and decode signal to be transmitted normally.

25.4 DRY RUN

In the dry run mode, the tool moves at the speed obtained by multiplying the dry run speed by the override value for manual feeding, regardless of the specified cutting federate. The dry run speed is specified in the corresponding parameter. However, the rapid traverse command (G00) and rapid traverse override value are effective. Dry run can also be commanded to rapid feed command (G00) by parameter setting.

25.5 SINGLE BLOCK

The program can be executed block by block under automatic operation.

25.6 **T series** MANUAL HANDLE RETRACE

During automatic operation, the program can be executed in the forward or reverse direction by using the manual handle (the manual pulse generator). Program errors can be checked easily by performing this manual handle operation while actually operating the machine.

- Check mode

In check mode, a program is executed in the forward or reverse direction to check the program. In check mode, this function creates data for reverse execution during forward execution of the program.

- Forward

Forward execution means that a program is executed in the forward direction without rotating the manual pulse generator or by turning the manual pulse generator in the positive direction.

The program execution speed is proportional to the speed of the manual pulse generator. As the manual pulse generator is turned in the positive direction quickly, the execution speed increases. As the manual pulse generator is turned slowly, the execution speed decreases. The amount of travel per pulse of the manual pulse generator can be changed by changing the magnification in the same way as ordinary handle feed.

- Reverse execution

Reverse execution means that a program once executed in the forward direction is executed in the reverse direction by turning the manual pulse generator in the negative direction.

Reverse execution of a program can be performed only for those blocks that have been executed in the forward direction. About up to 200 blocks can be executed in the reverse direction; the allowable number of blocks for reverse execution varies depending on the contents of a specified program.

The speed of the reverse execution of a program is proportional to the speed of the manual pulse generator. As the manual pulse generator is turned in the negative direction quickly, the execution speed increases. As the manual pulse generator is turned slowly, the execution speed decreases. The amount of travel per pulse of the manual pulse generator can be changed by changing the magnification in the same way as ordinary handle feed.

26

SETTING AND DISPLAY UNIT



26.1 SETTING AND DISPLAY UNIT

The setting and display units are shown in Subsections II-26.1.1 to II-26.1.5.

7.2"/8.4" LCD-mounted type CNC control unit : II-26.1.1

9.5"/10.4" LCD-mounted type CNC control unit : II-26.1.2

Stand-alone type small MDI unit: II-26.1.3

Stand-alone type standard MDI unit (horizontal type): II-26.1.4

Stand-alone type standard MDI unit (vertical type): II-26.1.5

26.1.1 7.2"/8.4" LCD-mounted Type CNC Control Unit

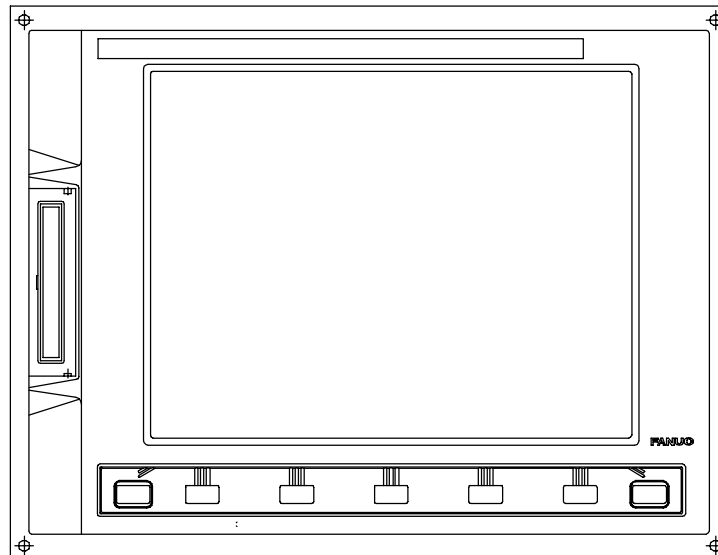

26.1.2
9.5"/10.4"
LCD-mounted Type
CNC Control Unit

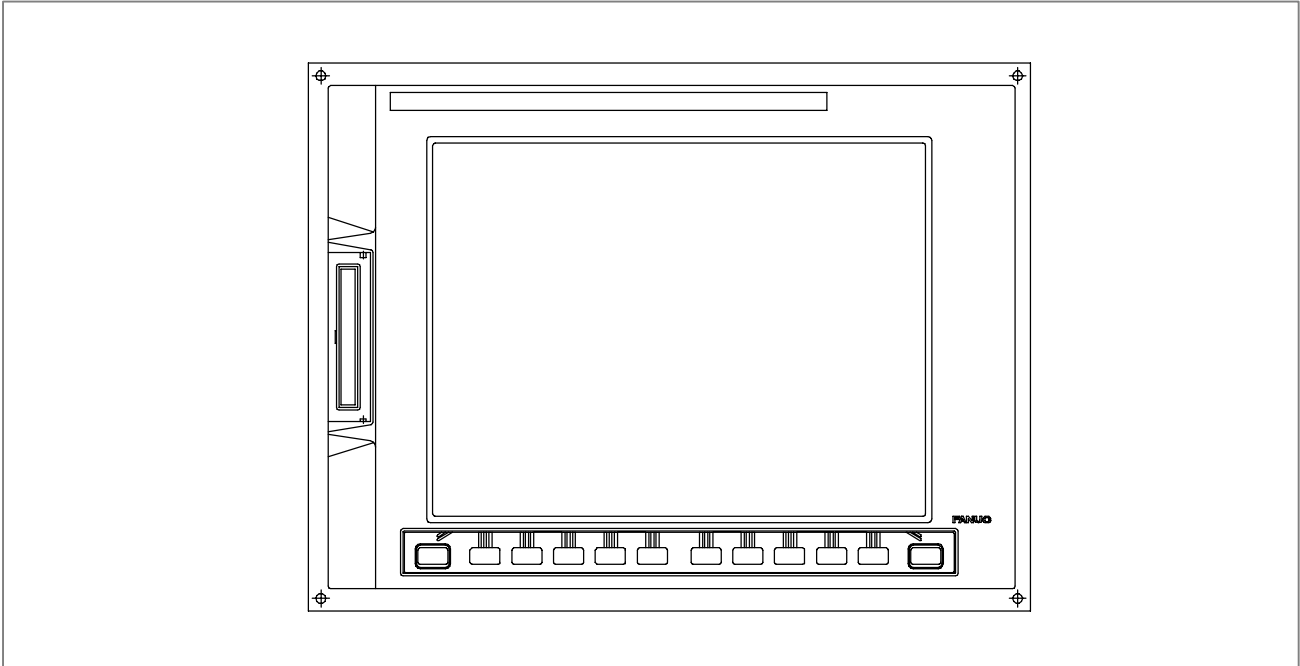

26.1.3 Stand-alone Type Small MDI Unit

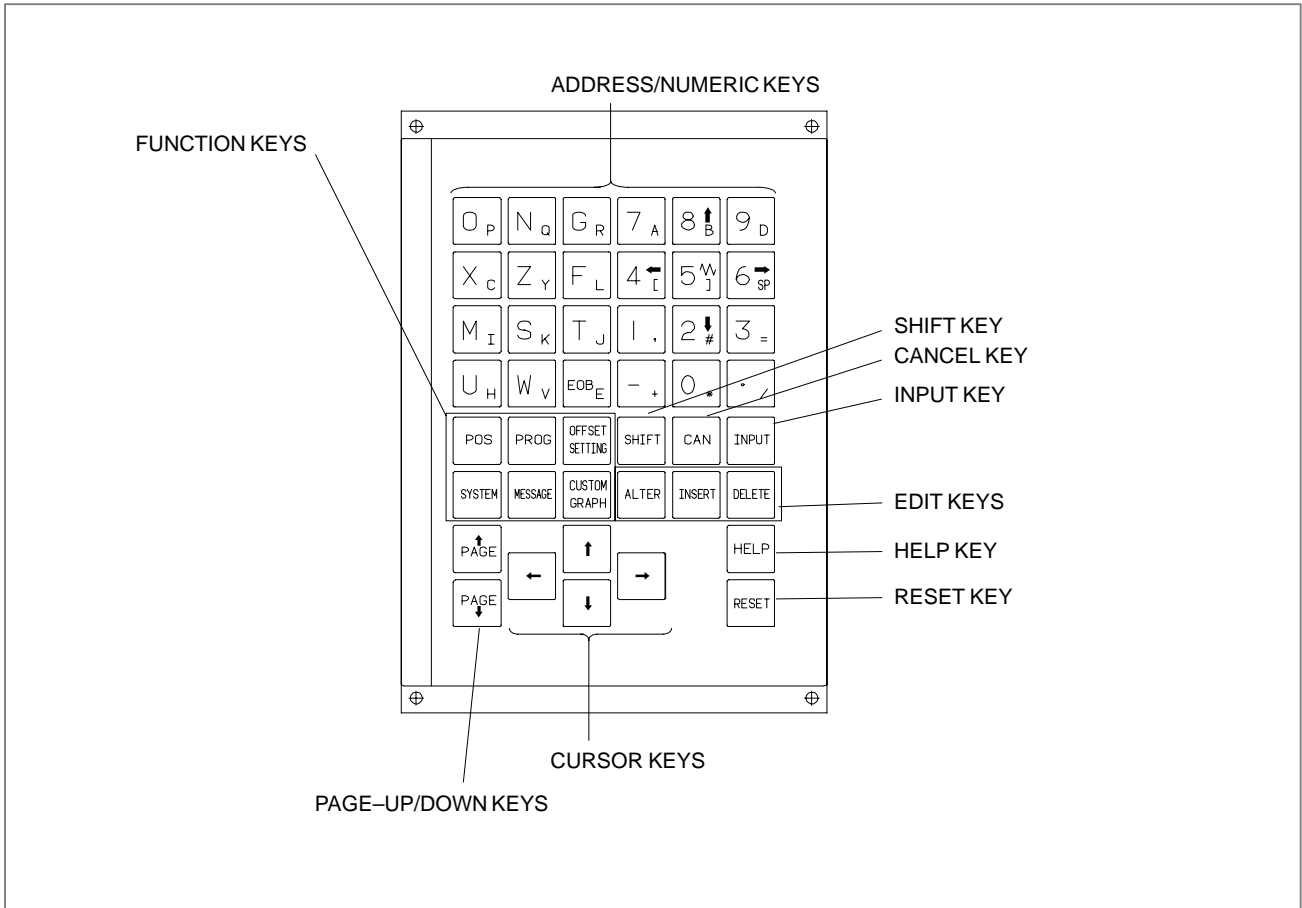



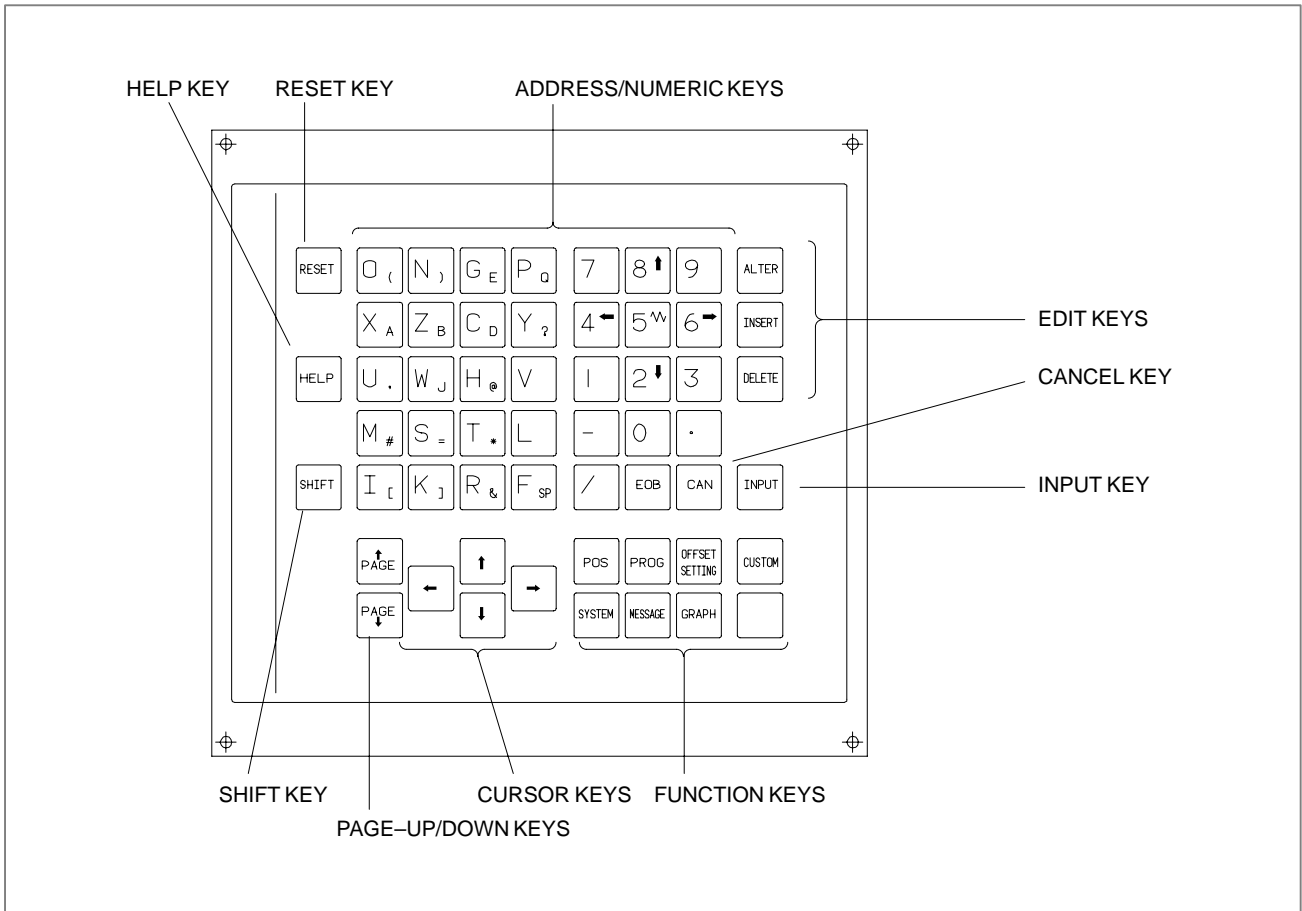



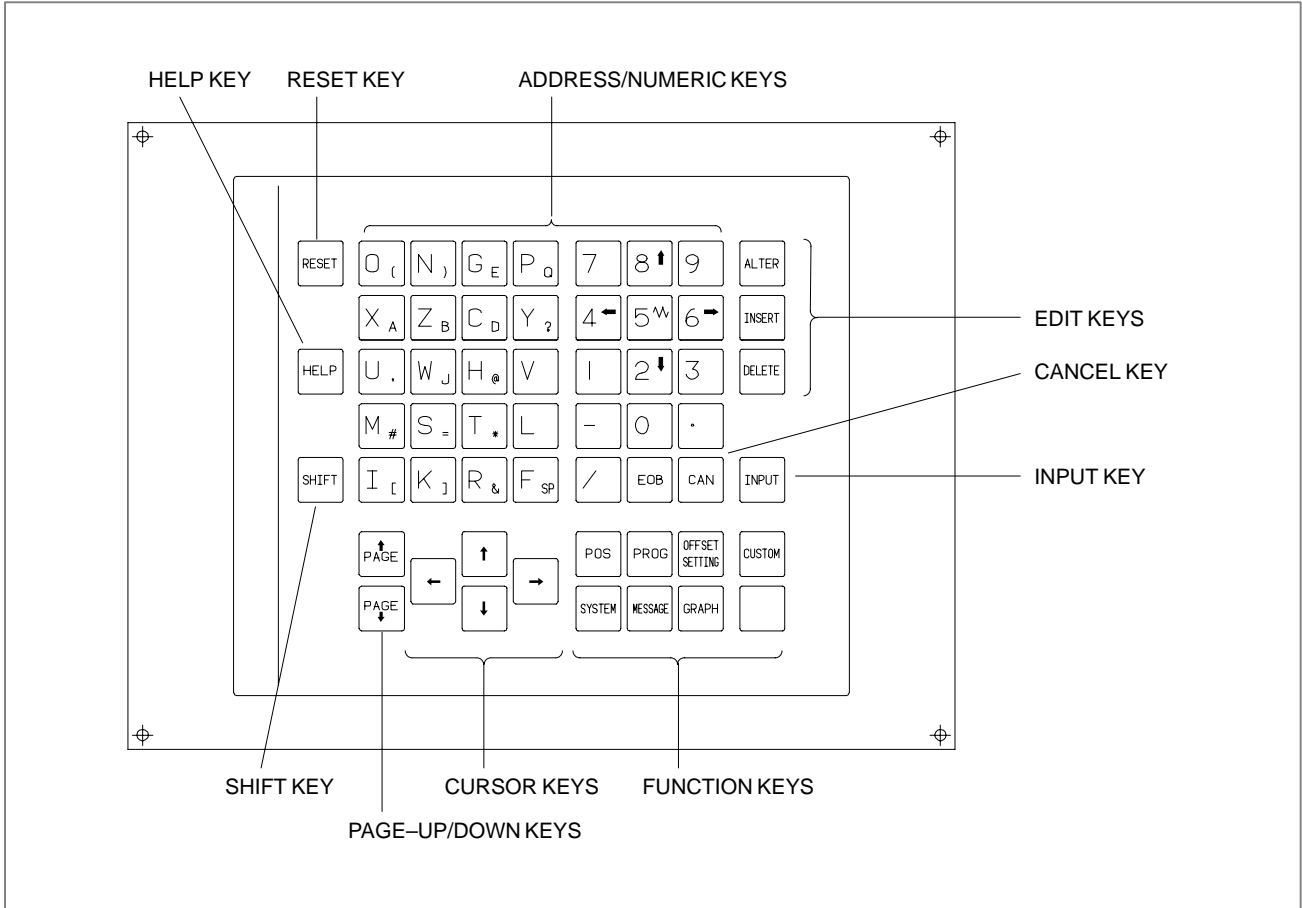









26.1.4 Stand-alone Type Standard MDI Unit (Horizontal Type)









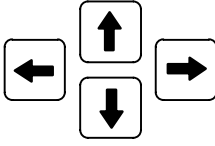

26.1.5 Stand-alone Type Standard MDI Unit (Vertical Type)









26.2 EXPLANATION OF THE KEYBOARD

No.	Key	Function
(1)	Reset key 	Used to reset the CNC to release an alarm or other similar state.
(2)	Help key 	Used to get help with operations such as for the MDI keys, when the operator does not know what to do next. For the 160i/180i/210i/160is/180is/210is, the Esc key on the personal computer takes the place of this key.
(3)	Soft keys	The soft keys are assigned different functions depending on the application. The functions currently assigned to the soft keys are displayed on the lowermost line of the screen.
(4)	Address/numeric keys   ...	Used to enter letters and numbers.
(5)	Shift key 	Some of the address keys have two different letters. When the shift key is pressed first before pressing one of these address keys, the lower-right letter is input. When the shift key is pressed, ^ is displayed in the key input buffer indicating that the lower-right letter will be input.
(6)	Input key 	Data input by pressing an address or numeric key is stored in the key input buffer, then displayed. When data input to the key input buffer needs to be written to the offset register, press the <INPUT> key. This key is equivalent to soft key [INPUT]. Either key may be used.
(7)	Cancel key 	Used to delete letters or numbers input to the key input buffer. Example) When N001X100Z is displayed on the key input buffer, pressing the cancel key deletes the letter Z, and N001X100 is displayed.
(8)	Edit keys   	Used to edit programs.  : Alter  : Insert  : Delete
(9)	Function keys   ...	Used to switch screens for each function. For the 160i/180i/210i/160is/180is/210is, the Alt key on the personal computer takes the place of  and the Ctrl key takes the place of  .

No.	Key	Function
(10)	Cursor keys 	Four cursor keys are provided.  : Moves the cursor to the right or forwards in small units.  : Moves the cursor to left or backwards in small units.  : Moves the cursor downward or forwards in large units.  : Moves the cursor upward or backwards in large units.
(11)	Page-up/down keys  	Page-up and page-down keys are provided.  : Used to display the next page.  : Used to display the previous page.

26.2.1 Explanation of the Function Keys

The function keys select what is displayed. Each function is divided into sub-functions, and the sub-functions are selected by soft keys.

There are six function keys :  ,  ,  ,  ,  , and  .

 : Displays the current position.

 : Displays and edits a program stored in memory.

 : Displays an offset value, offset from the workpiece zero point, custom macro variable, and tool life management data. Allows data to be input into these items.

 : Displays and sets a parameter and pitch error compensation value, and displays self diagnostic data.

 : Displays an alarm message, external operator message, external alarm message, and alarm history.

 : Displays graphic data.

 : Press this key to display the custom screen (conversational macro screen).

In case of 160i/180i/210i/160is/180is/210is, this key is assigned to “Ctrl” key of the personal computer.

To display the custom screen with the CNC screen display

function, press  +  .

 : In case of 160i/180i/210i/160is/180is/210is, this key is assigned to “Alt” key of the personal computer.

26.2.2 Explanation of the Soft Keys

The MDI panel has 10 soft keys (or 5 soft keys), a next-menu key on the right, and a previous-menu key on the left. The next menu key and previous menu key are used to select the functions of the soft keys. These soft keys can be assigned with various functions, according to the needs.

The following functions are mainly available via the MDI panel:

- Actual position display
- Contents of program display, program directory display (display of program number, program name, part program storage length left, number of programs left)
- Program editing
- Offset amount display and setting
- Commanded value display, MDI input
- Parameter setting and display
- Alarm message/operator message display
- Custom macro variables display and setting
- Tool life management data display and setting
- Diagnosis
- Others

This manual may refer to a display device with 10 + 2 soft keys as a 12 soft key type, and a display device with 5 + 2 soft keys as a 7 soft key type.

27

DISPLAYING AND SETTING DATA



The display on the 160i/180i/210i/160is/180is/210is with a personal computer function differs from the display on the 16i/18i/21i with no personal computer function. This chapter presents the display screens when the personal computer function is not provided and explains how to make settings.

To display standard CNC screens on the 160i/180i/210i/160is/180is/210is, use the CNC screen display function. For details of the CNC screen display function, refer to "Screen Display Function Operator's Manual (B-63164EN)."

27.1 DISPLAY

The following data are displayed. 7 soft keys can display maximum 640 characters (40 × 16 lines) and 12 soft keys can display maximum 2080 (80 × 26 lines).

Explanations

- **Indication of statuses and tool post names**

The status of the control unit is indicated on the screen. Statuses include the state when an alarm is being activated or when the system is in the edit mode. The status line is displayed right above the soft key line.

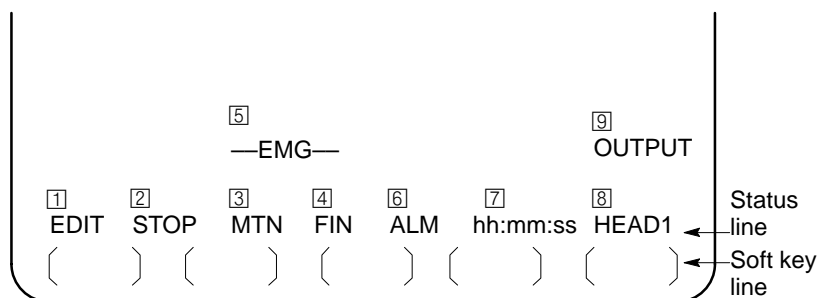

- ① Operation mode (MDI, MEM, RMT, EDIT, HND, TJOG, THND, INC, or REF)
- ② Status of automatic operation (STOP, HOLD, STRT, or *****)
 ***** : Reset
 STOP : Automatic operation is in a stopped state.
 HOLD : Automatic operation is in a halt state.
 STRT : Automatic operation has been started.
- ③ Axis movement/dwell (MTN, DWL, or ***)
- ④ FIN wait state (FIN or ***)
- ⑤ Emergency stop (--EMG--) (displayed above in 3 and 4)
- ⑥ Alarm status (ALM, WNG, or ***)
- ⑦ Clock (hh:mm:ss)
- ⑧ Name of the path currently selected (only at 2-path control)

NOTE

The name of a path can be specified by the corresponding parameter with a string of up to seven characters. The characters may be numbers, letters, katakana characters, or symbols.

- ⑨ Status display such as program editing (INPUT, OUTPUT, SRCH, EDIT, LSK, or RSTR)
 (⑧ and ⑨ are displayed in the same column. When a program is being edited, ⑨ is displayed.)

- **Key input display**

Data input via the address keys or the numerical keys are displayed at the left lower part of the screen.

- **Program number, sequence number display**

Program number, sequence number is displayed on the right upper part of the screen.

- **Alarm display**

Alarm number and its contents are displayed briefly.

- **Alarm message display** Alarm message contents are displayed.
- **Present position display** Relative position and position in the work coordinates are displayed in 3-times magnified characters.
- **Total position display** Relative position, position in the work coordinates, position in the machine coordinate, and remaining move distance are displayed in one screen.
- **Command value display** The following two displays are performed.
 - Previously commanded modal value and command value to be executed (ACTIVE)
 - Command value of the next block
- **Setting (parameter set by the operator) display** Displays setting value.
- **Tool offset amount display** Displays offset value. Relative position is also displayed at the same time.
- **Program display**
 - Display of program for editing.
 - Display of program currently under execution.
 - Display of program list.
A list of program number and program name, of programs stored in the memory is displayed.
Used memory size and remaining memory size are also displayed.
- **Parameter display**
- **Self diagnosis result display**
- **Custom macro variables display**
- **External operator message, external alarm message display**
- **Actual speed and actual spindle speed**
 - Actual feedrate per minute (mm/min or inch/min)
Movement along an arbitrary axis can also be excluded from the actual feedrate indications by parameter setting.
 - Actual spindle speed (min^{-1})
- **Program check screen** The following are displayed on one screen.
 - Program number on execution
 - Sequence number on execution
 - Program text on execution
 - Current position
 - Modal G codes
 - Modal M codes
 - T code
 - Actual feedrate and spindle speed
 - Status

- **Operating monitor display**

The load values (torque values) of spindle motor and servo motor are displayed in bar chart.

The most recent sampling values are displayed in bar chart display. Set the rated load value of motor corresponding to each load meter to parameters. The load meter displays 100% when the load value is the rated load value.

The load meter can be displayed up to three servo motor axes and a parameter can be used to select any one of three axes.

- **Displaying the alarm history**

A maximum of 25 of the most recent alarms generated in CNC can be recorded. Each alarm record consists of the following items:

- Date and time
- Alarm number
- Alarm message

Any of the records can be deleted from the alarm history.

In addition, the operator message history can be displayed.

```

ALARM HISTORY                                00100 N00001

01. 02. 14 16:43:48
-----
  2 010  3 IMPROPER G-CODE
01. 02. 13  8:22:21
  506  OVER TRAVEL    :+1
01. 02. 12 20:15:43
  417  SERVO ALARM   :X AXIS DGTL PARAM

MEM **** * 09:36:48
[ ALARM ][ MSG ][ HISTORY ][ (OPRT) ]

```

- **Displaying external operator message history**

The history of external operator messages can be stored. The stored history can be displayed on the external operator message history screen.

27.2 LANGUAGE SELECTION

The Japanese, English, German, French, Italian, Spanish, Chinese, and Korean, Portuguese, Hungarian, Polish, Swedish, Czech, and Dutch (M series only) are prepared as display languages. Select the language to be displayed by parameters.

(Supporting non-English displays requires the option that matches the relevant language.)

27.3 CLOCK FUNCTION

Time is displayed in the hour/minute/second format on each display screen. Some screens allow display of the year, month, and day.

The custom macro system variable can be used to read the time. The time will be told through the window at PMC side.

27.4 RUN TIME & PARTS NUMBER DISPLAY

This function displays the integrated power-on time, the integrated cycle operation time, the integrated cutting time and timer on the CRT display screen. The integrated cycle operation time, the integrated cutting time and timer can be altered and preset, using the MDI.

In addition to the above, this function displays the count of the total number of parts machined, the number of parts required and the number of parts on the screen. Each time M02, M30 or a parameter set M code is executed, the count of the total in memory is incremented by 1.

If a program is prepared so as to execute M02, M30 or a parameter set M code each time one part machining is completed, the number of parts machined can be counted automatically.

If the count of the number of parts reaches the number of parts required, a signal is output to the PMC side.

It is possible to change and preset the number of parts required and the number of parts counted, using MDI.

The number of required parts and the number of counted parts can be read and written using custom macro variables. These values can also be read using the external data input function.

```

SETTING (TIMER)                                00000 N00000

PARTS TOTAL      =      0
PARTS REQUIRED    =     25
PARTS COUNT      =     10

POWER ON         =     0H 0M
OPERATING TIME   =     0H 0M 0S
CUTTING TIME     =     0H 0M 0S
FREE PURPOSE     =     0H 0M 0S
CYCLE TIME       =     0H 0M 0S
DATE = 2001 04/10
TIME = 16:20:30

>_
MDI **** * 16:20:30
[ OFFSET ] [ SETTING ] [ ] [ ] [ (OPRT) ]

```

27.5 SOFTWARE OPERATOR'S PANEL

In this function, functions of switches on the machine operator's panel is done by operation on the MDI panel. Mode selection and jogging override, etc. can be operated by setting operation via the MDI panel with this function, thus allowing committance of corresponding switches on the machine operator's panel.

This function is valid only when the screen is displayed with operator's panel. Move cursor with the cursor operation keys, and select various operations, viewing the screen.

The following operations can be done via the MDI panel:

- A** Model selection
- B** Manual pulse generator feed axis selection (available only with manual handle 1)
Move distance selection per pulse of manual pulse generator
- C** Rapid traverse override
Jogging speed override
Feedrate override
- D** Optional block skip (Block delete)
Single block
Machine lock
Dry run
- E** Memory protect
- F** Feed hole
- G** Jogging/incremental feed axis direction selection
Manual rapid traverse selection
- H** General-purpose switch: Eight general-purpose switches are provided and each of these switches can be named by up to eight alphanumeric characters.

There is a parameter per groups A to G shown above, which decides validity of operation function by MDI panel.

```

OPERATOR'S PANEL                                00000 N00000

MODE : MDI AUTO EDIT STEP JOG ZRN

STEP MULT. : *1 10 *100
RAPID OVRD. : 100% 50% 25% 0
JOG FEED   : 1.0%
           *****
FEED OVRD. : 140%
           *****
ACTUAL POSITION (ABSOLUTE)
X      0.000      Z      0.000
                               S      0 T0000
EDIT **** * 09:36:48
[ MACRO ] [ ] [ OPR ] [ TOOLLF ] [ ]

```

OPERATOR'S PANEL

O0000 N00000

BLOCK SKIP : OFF ON
SINGLE BLOCK : OFF ON
MACHINE LOCK : OFF ON
DRY RUN : OFF ON
PROTECT KEY : PROTECT RELEASE
FEED HOLD : OFF ON

ACTUAL POSITION (ABSOLUTE)

X 0.000 Z 0.000

S 0 T0000

EDIT **** ** *

09:36:48

[MACRO] [] [**OPR**] [TOOLLF] []

27.6 DIRECTORY DISPLAY OF FLOPPY CASSETTE

File names in the floppy cassette (FANUC CASSETTE F1) and program file (FANUC PROGRAM FILE Mate) can be listed on the display (directory display). Each file name of up to 17 letters can be displayed in directory display.

Files in the floppy cassette are:

Part program, parameter/pitch error compensation data, tool compensation data, and etc.

When part program in part program memory is written into the floppy cassette, program number can be given to it as a file name. When NC parameter is written into the floppy cassette, "PARAMETER" is given them as a fixed name. When tool compensation data is written into the floppy cassette, "OFFSET" is given to it as a fixed name.

DIRECTORY (FLOPPY)		O0000 N00000
NO.	FILE NAME	(METER) VOL
0001	PARAMETER	46.1
0002	ALL.PROGRAM	12.3
0003	O0001	1.9
0004	O0002	1.9
0005	O0003	1.9
0006	O0004	1.9
0007	O0005	1.9
0008	O0010	1.9
0009	O0020	1.9

EDIT **** * * * * * 09:36:48
[F SRH] [READ] [PUNCH] [DELETE] []

27.7 GRAPHIC DISPLAY FUNCTION

27.7.1 Graphic Display Function

This function allows display of tool path on the screen, making program check easier. The following functions are offered.

- Tool path of the machining program can be displayed. Machining process can be checked just by viewing the tool path drawing on the screen.
Program check before machining can be done by displaying the programmed locus on the screen.
- For M system, display is possible with the XY plane, YZ plane, ZX plane, or isometric; for T system, with the XZ plane.
- Scaling of the screen is possible.

Tool path drawing (M series)

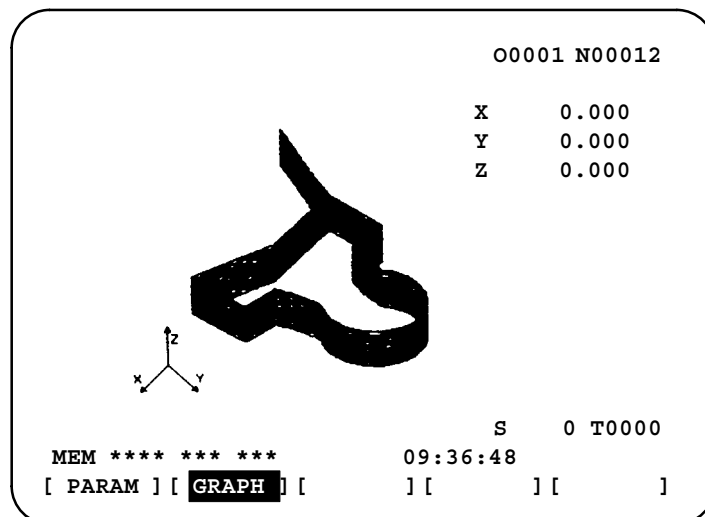

Graphic display of tool path (M series)

27.7.2 Dynamic Graphic Display

Created programs can be checked visually by displaying them using graphic data.

Dynamic graphic display function (for M series)

Graphic data can be displayed in the following two drawing modes:

- **Tool path drawing mode**

Tool paths are drawn with lines so programs can be checked closely.

- Because tool paths are drawn at a high speed, programs can be checked quickly.

Two-dimensional drawing

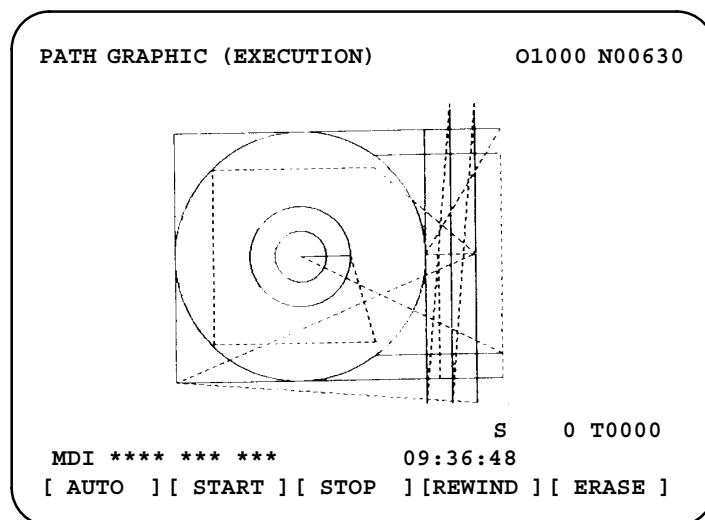

- With the automatic scaling function, figures can be drawn on the center of the screen at a desired magnification.
- On a drawing, any part of a figure can be magnified easily by specifying its center and scale.

Enlarged-view drawing

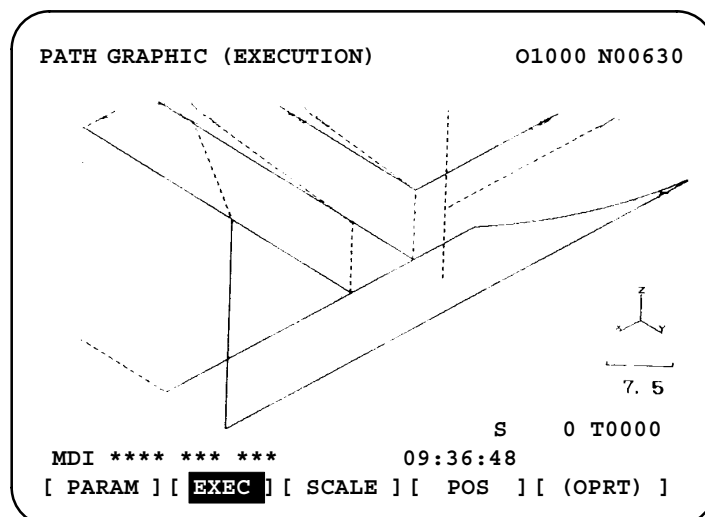

- In addition to two-dimensional drawings, isometric projection drawings and biplanar drawings can be created.

Isometric projection drawing

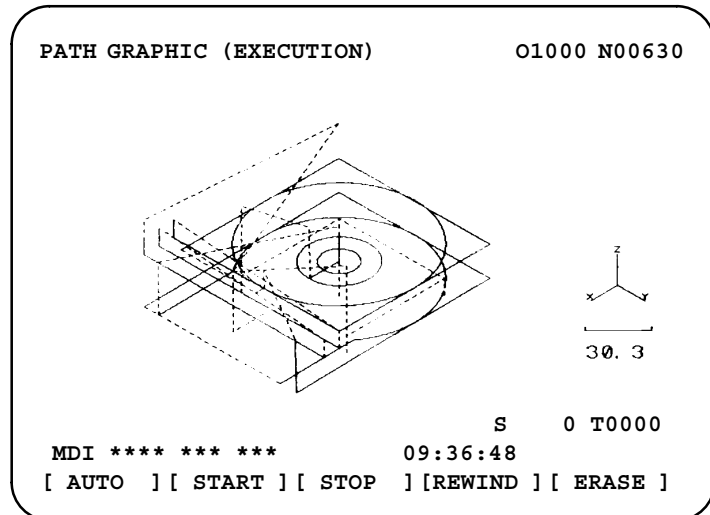

- Because the current position of a tool is marked on the drawn tool path, the progress of machining can be monitored accurately.

Biplanar drawing

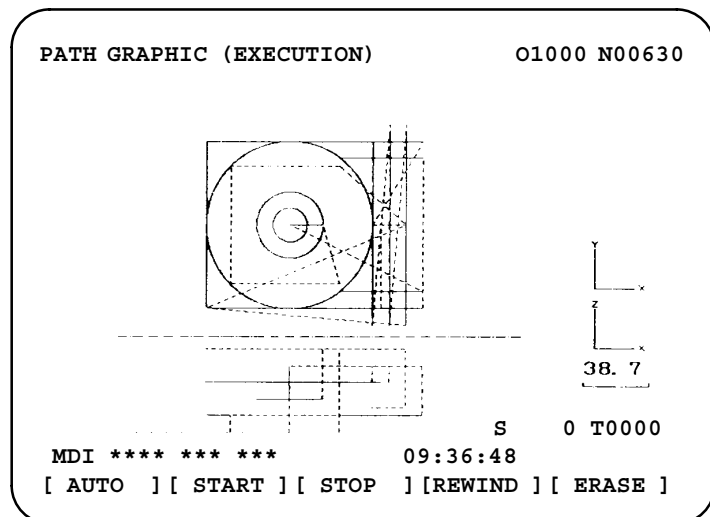

- **Machining profile drawing mode**

- The profile of a workpiece that changes as the tool moves can be simulated and drawn three-dimensionally, making it easier to check programs visually.

Blank figure

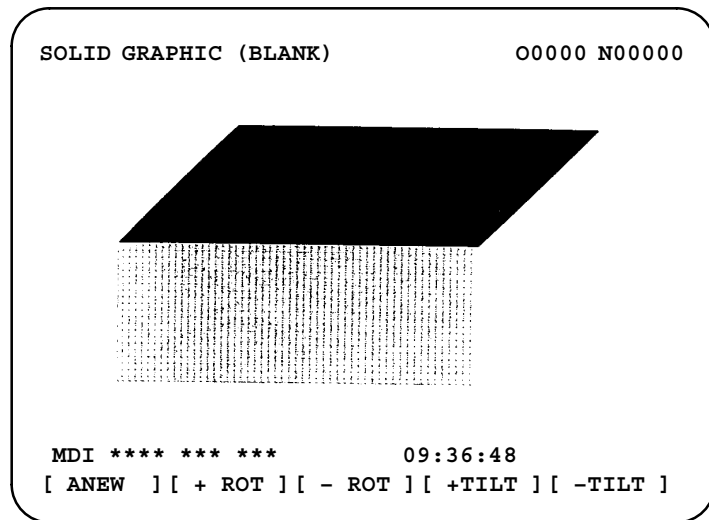

Final figure

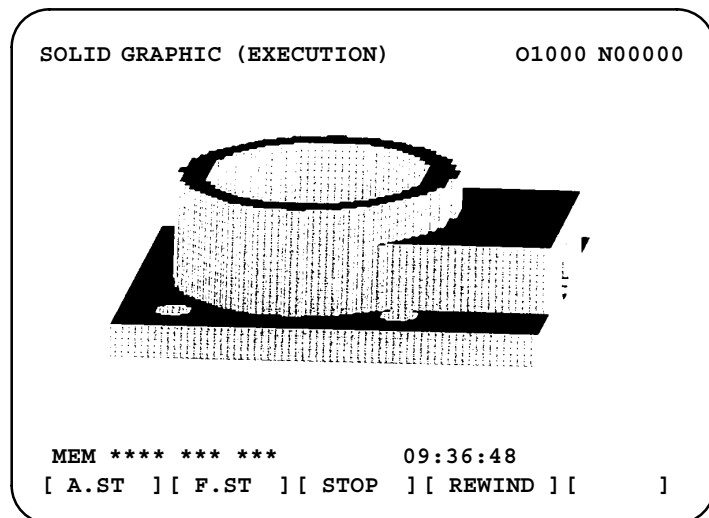

- The coordinate axes and projection angles can be changed at the operator's option.

Modification of a coordinate axis (inclination)

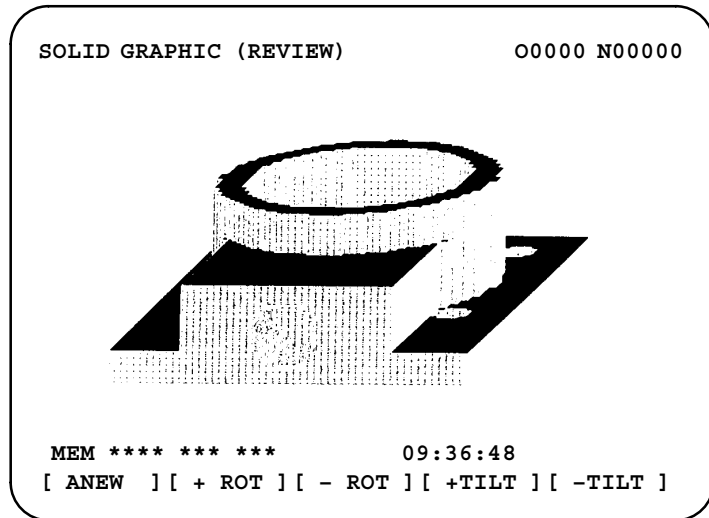

Modification of a coordinate axis (inclination)

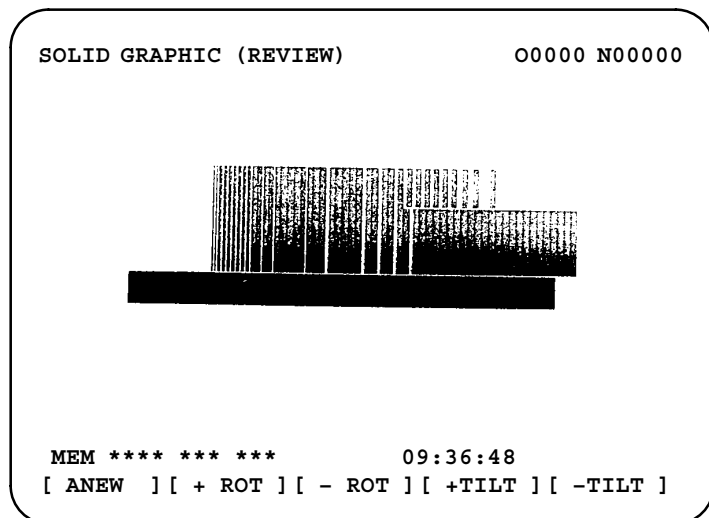

- In addition to three-dimensional drawings, two-dimensional drawings and tri-planar drawings can be created.

Two-dimensional drawing

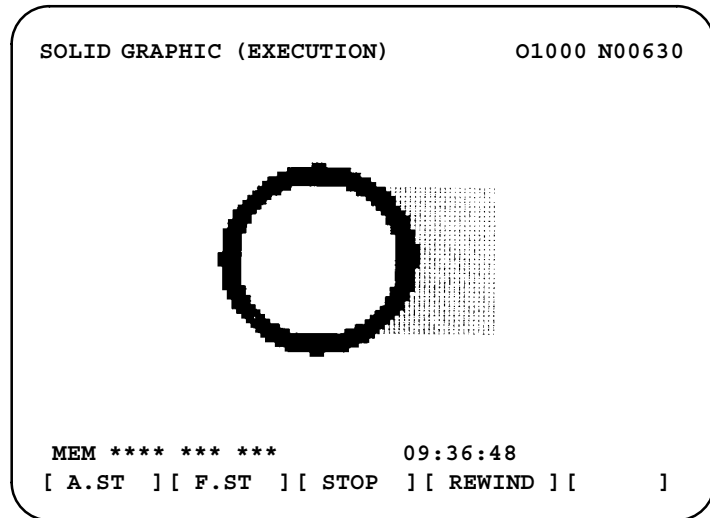

Tri-planar drawing

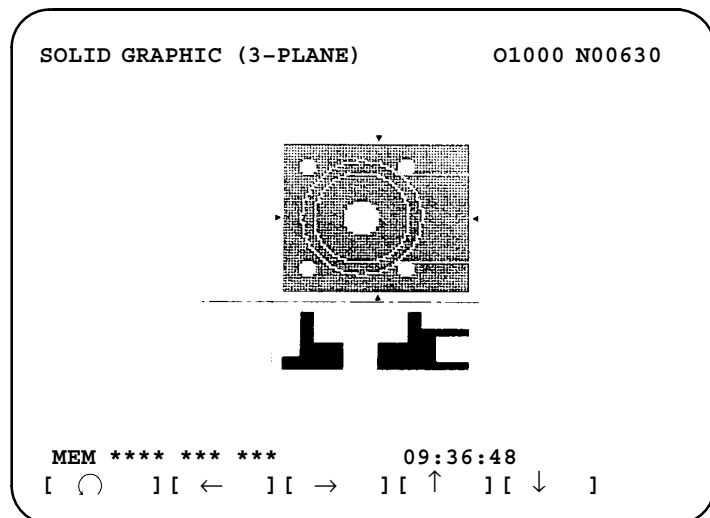

Dynamic graphic display function (for T series)

- Tool path drawing mode
- Animated drawing mode

The following two display modes are available.

These functions are provided for conversational automatic programming function for lathe.

Movement of the tool tip is drawn with fine lines.

Accurate figures of the material, chuck, and tailstock are displayed on the screen. An animated simulation illustrates how the material will be cut by the tool.

27.7.3 **M series** Background Drawing

The background drawing function enables the drawing of a figure for one program while machining a workpiece under the control of another program.

Explanations

- **Program selection**

Immediately after entering background drawing mode with operation of MDI key, the program which was selected previously remains selected. Any program can be selected for background drawing, by using the background drawing screen.

Parameter setting and drawing method are same as synamic graphic display.

27.8 SERVO WAVEFORM FUNCTION

The waveforms of servo data items (errors, torques, timing pulses, etc.) and signals between the CNC and the PMC can be displayed.

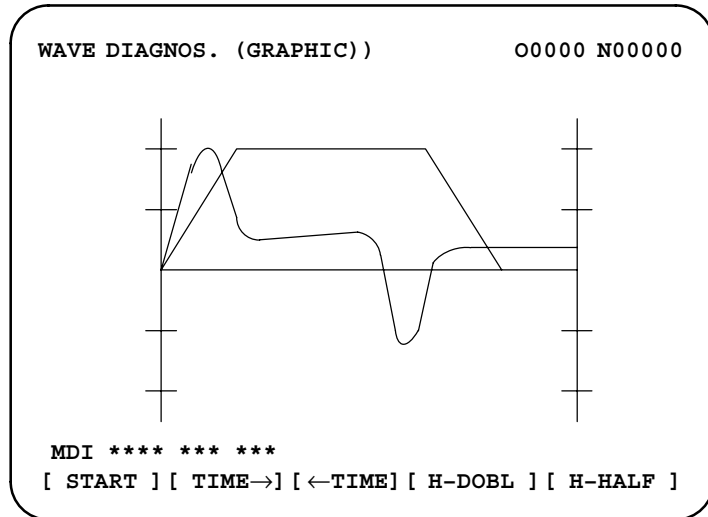

On this screen, the sampling period (6 to 32767 ms) and drawing start conditions can be specified.

27.9 SCREENS FOR SERVO DATA AND SPINDLE DATA

27.9.1 Servo Setting Screen

On the servo setting screen, parameters required for standard initialization of the servo motor are listed. The parameters can also be set.

```

SERVO SETTING                                00000 N00000

                X AXIS      Y AXIS
INITIAL SET BIT      000000011  00000001
MOTOR ID NO.         12         12
AMR                  00011111  00011111
CMR                   2         2
FEEDGEAR N           3         3
(N/M) M              10        10
DIRECTION SET        111        111
VEROCITY PULSE NO.   8000       8000
POSITION PULSE NO.   8000       8000
REF COUNTER          8000       8000

MDI **** * * * * *      09:36:48
[ SV.SET ] [ SV.TUN ] [ ] [ ] [ (OPRT) ]

```

27.9.2 Servo Adjustment Screen

On the servo adjustment screen, parameters required for basic adjustment of the servo motor and statuses being monitored are listed for each axis.

```

SERVO SETTING                                01000 N00000
X AXIS
(PARAMETR)                                (MONITOR)
FUNC.BIT      00110100  ALARM 1      00110100
LOOP GAIN      3000     ALARM 2      00110100
TUNING ST.     1       ALARM 3      00000000
SET PERIOD     50     ALARM 4      00000000
INT.GAIN       251    LOOP GAIN      3000
PROP.GAIN      -2460  POS ERROR      100
FILTER         2450  CURRENT %      50

>_
MEM STAT MTN * * * * *      09:36:48
[ SV.SET ] [ SV.TUN ] [ ] [ ] [ (OPRT) ]

```

27.9.3 Spindle Setting Screen

On the spindle setting screen, parameters required for standard initialization of the serial spindle are listed. The parameters can also be set.

```

SPINDLE SETTING                                00000 N00000

GEAR SELECT   :1
SPINDLE       :1

(PARAMETER)
GEAR RATIO                50
MAX SPINDLE SPEED        3000
MAX MOTOR SPEED          6000
MAX C AXIS SPEED         100

>_
MDI **** * 09:36:48
[ SP.SET ][ SP.TUN ][ SP.MON ][   ][ (OPRT) ]

```

27.9.4 Spindle Adjustment Screen

On the spindle adjustment screen, parameters required for basic adjustment of the serial spindle and statuses being monitored are listed.

```

SPINDLE TUNING                                01000 N00000

OPERATION      : SYNCHRONIZATION CONTROL
GEAR SELECT    : 1
SPINDLE        : S11
(PARAMETER)
PROP.GAIN      -2460  MOTOR 100
INT.GAIN       241   SPINDLE 150
LOOP GAIN      3000  POS ERR S1 100
MOTOR VOLT     30
ZRN GAIN %     100   SYN.ERROR 128
REF.SHIFT      2046

>_
MEM STAT MTN *** * 09:36:48
[ SP.SET ][ SP.TUN ][ SP.MON ][   ][ (OPRT) ]

```

27.9.5 Spindle Monitor Screen

On the spindle monitor screen, various data items related to the spindle are listed.

```

SPINDLE MONITOR                                O1000 N00000
ALARM      : AL-27 (PC DISCON.)
OPERATION  : SP.CONTOURING CONTROL
FEED SPEED :      100 DEG/MIN
MOTOR SPEED :      150 RPM
           0   50  100  150  200 (%)
LOAD METER (%)
           ██████████
CONTROL INPUT : MRDY *ESP ORCM
CONTROL OUTPUT : ORAR SST

>_
MEM **** * * * * *                09:36:48
[ SP.SET ] [ SP.TUN ] [ SP.MON ] [   ] [ (OPRT) ]

```

27.10 SYSTEM CONFIGURATION DISPLAY FUNCTION

The configurations of software and hardware required for maintenance of the CNC are displayed.

The system configuration display function provides the following three screens:

- Slot information screen
- Software information screen
- Hardware (module) information screen

Slot information

SYSTEM CONFIG					O1234 N56789
SLOT	MODULE_ID	SERIES	VERSION		
00	3008 :40	B1H1	0001		
01	00CF :66	B435	0001		
03	019D :41	4068	0001		
↑	↑	↑	↑	↑	
①	②	③	④	⑤	
MEM **** * * * * *					18:46:43
[PARAM] [DGNOS] [PMC] [SYSTEM] []					

- ① Slot No.
- ② Module ID
- ③ Software ID
- ④ Software series
- ⑤ Software edition

Software information

SYSTEM CONFIG (SOFTWARE)			O1234 N56789
SYSTEM	BOH1	0001	
	BASIC+OPTION-A1		← ④
SERVO	90B0	0001	
PMC (SYS)	406G	0001	
	406G	0001	
PMC (LAD)	FS16	0001	
MACRO LIB	BZG1	0001	
BOOT	60M5	0001	
GRAPHIC-1	60V5	0001	
GRAPHIC-2	60V6	0001	
EMBED ETH	656A	0001	
↑	↑	↑	
①	②	③	
MEM **** * * * * *			19:14:23
[PARAM] [DGNOS] [PMC] [SYSTEM] []			

- ① Software type
- ② Software series
- ③ Software edition
- ④ Contents of ROM (system ROM only)

Hardware (module) information

The slot number, board name, modules mounted on the board are displayed for each slot.

```

SYSTEM CONFIG (MODULE)          01234 N56789
  ↓ ①
SLOT 00 MOTHER BOARD ← ②

  AXIS CTRL CARD      : 08
  DISPLAY CTRL CARD   : 0E
  CPU CARD            : 11
  FROM DIMM           : C1
  SRAM DIMM           : 05
  DRAM DIMM           : A9
  PMC CPU             : 01
  ↑                 ↑
  ③                 ④

MEM **** * * * *          19:33:34
[ PARAM ] [ DGNOS ] [ PMC ] [ SYSTEM ] [ ]

```

- ① Slot number (The slot number corresponds to the number displayed on the slot information screen.)
- ② Name of the PC board inserted in the slot
- ③ Hardware (modules) mounted on the PC board
- ④ Types of hardware (modules), mounted/not mounted

27.11 HELP FUNCTION

When an alarm occurs, or when the operator is not certain what to do next, pressing the  key on the MDI panel displays detailed alarm information or instructions for operation.

One of the following three screens can be displayed:

- On the alarm detail screen, detailed information on the alarm currently activated is displayed. Using this information, the operator can identify the cause of the alarm and what action to take. Any alarm information can be displayed on this screen.
- On the operation instruction screen, when the operator is not sure of what to do next during CNC operation (i.e., program editing and data input/output) necessary instructions are displayed.
- Parameter numbers are listed on the parameter list screen. When the number of the parameter to be set or referenced is unknown, bring up this screen.

- An alarm detail screen for when an alarm (P/S 094) is activated.

```

HELP (ALARM DETAIL)                                O1234 N00001

NUMBER: 094
M' SAGE: P TYPE NOT ALLOWED (COORD CHG)
FUNCTION: RESTART PROGRAM
ALARM:
  WHEN COORDINATE SYSTEM SETTING IS
  CONDUCTED AFTER HOLDING
  AUTOMATIC OPERATION, P-TYPE (WHEN TOOL IS
  DAMAGED) PROGRAM
  RESTART CANNOT BE EXECUTED.

MEM **** *ALM 09:36:48
[ ALAM ][ OPR ][ PARA ][ (OPRT) ]

```

- Parameter list screen

```

HELP (PARAMETER TABLE)                            O1234 N00001
                                                    1/4
*SETTING (NO.0000 - )
*READER/PUNCHER INTERFACE (NO.0100 - )
*AXIS CONTROL/SETTING UNIT (NO.1000 - )
*COORDINATE SYSTEM (NO.1200 - )
*STROKE LIMIT (NO.1300 - )
*FEED RATE (NO.1400 - )
*ACCEL/DECELERATION CTRL (NO.1600 - )
*SERVO RELATED (NO.1800 - )
*DI/DO (NO.3000 - )

MEM **** *PARA 09:36:48
[ ALAM ][ OPR ][ PARA ][ (OPRT) ]

```

□ Operation instruction screen

```

HELP (OPERATION METHOD)                01234 N00001
<<1. PROGRAM EDIT>>                    1/4
*DELETE ALL PROGRAMS
  MODE : EDIT
  SCREEN: PROGRAM
  OPR  : (0-9999) - <DELETE>

*DELETE ONE PROGRAM
  MODE : EDIT
  SCREEN: PROGRAM
  OPR  : (0+PROGRAM NUMBER) - <DELETE>

>_                                     S    0 T0000
MEM **** *** ***                      09:36:48
[ ALAM ] [ OPR ] [ PARA ] [ ] [ (OPRT) ]

```

27.12 DATA PROTECTION KEY

A data protection key can be installed on the machine side for protection of various NC data. The following four input signals are offered, according to type of data to be protected.

- **KEY 1**
Allows input of tool compensation amount and work zero point offset amount.
- **KEY 2**
Allows setting data input and macro variable input.
- **KEY 3**
Allows part program input and editing.
- **KEY 4**
Allows PMC data (counter, data table) input.

27.13 DISPLAYING OPERATION HISTORY

This function displays a history of the key and signal operations, performed by the operator, upon the occurrence of a failure or alarm. The history can also be displayed for previously generated alarms.

The following history data is recorded :

- MDI key/soft key operation sequences
Example : A to Z, <POS>, <PAGE↑>, [SF1]
- On/off status transitions of selected input and output signals
Example : G0000.7↑, SBK↑
- NC alarm information
Example : P/S0010
- Time (date, time) stamp
Example : 01/04/10
09:27:55

The history data can be output to an input/output device, connected via the reader/punch interface. Previously output history data can be input from an input/output device.

27.14 MACHINING TIME STAMP FUNCTION

When a machining program is executed, the machining time of the main program is displayed on the program machining time display screen. The machining times of up to ten main programs are displayed in hour/minutes/seconds. When more than ten programs are executed, data for the oldest programs is discarded.

27.15 REMOTE DIAGNOSIS

The remote diagnosis function allows you to use a commercially available personal computer as a service terminal and connect it to a CNC via an RS-232C interface or telephone line for monitoring the CNC status and modifying CNC data from the personal computer.

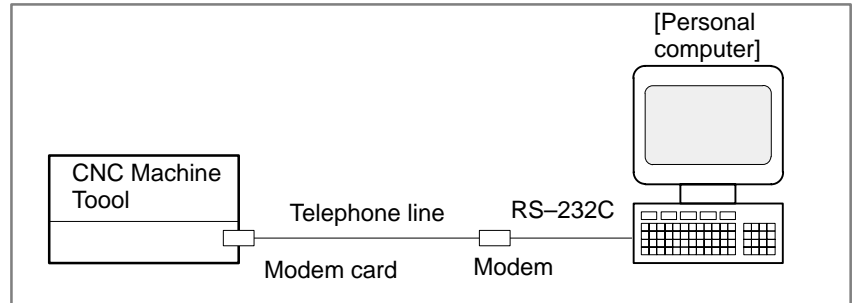

The remote diagnosis terminal software is sold separately.
The remote diagnosis function provides the following capabilities :

CNC programs

- 1) Computer → CNC
 - CNC command data for verification
 - Searching for a specified program
 - Part program
 - Deleting a specified program
 - Deleting all programs
- 2) CNC → computer
 - Part program
 - Displaying a program directory
 - Program number of a program being executed
 - Sequence number of a sequence being executed

Computer → CNC

- Parameter
- Pitch error data
- Tool offset value
- Custom macro variable
- Selecting a display screen
- Memory contents
- PMC data
- Displaying a specified message
- All parameters

- CNC → computer
 - Alarm information
 - Machine position
 - Absolute position
 - Skip position
 - Servo delay
 - Acceleration/deceleration delay
 - Diagnosis
 - Parameter
 - Tool life management data
 - Display screen status
 - Modal information
 - Pitch error data
 - Tool offset value
 - Custom macro variable
 - Memory contents
 - Ladder program
 - Actual feedrate
 - Status
 - A/D conversion
 - PMC data
 - Screen character data
 - Printed circuit board information
 - Ladder title
 - Series and edition of PMC/ladder
 - All parameters
- File function selection
 - Listing files
 - Referring a file
 - Deleting a file
 - Copying a file
 - Renaming a file
 - Linking a file
 - Changing the current directory
 - Creating a directory
 - Deleting a directory

NOTE

- 1 An arrow “→” indicates the direction of data flow.
- 2 For the 160i/180i/210i/160is/180is/210is, the remote diagnosis relay function must be started. For details, refer to the Readme files on the Open CNC Drivers Disk (A02B-0207-K792) and in the Open CNC Standard Application Library (A02B-0207-K736).

27.16 DIRECTORY DISPLAY AND PUNCH FOR A SPECIFIED GROUP

CNC programs stored in memory can be grouped according to their names, thus enabling the listing and output of CNC programs on a group-by-group basis.

To assign multiple CNC programs to a single group, assign names to those programs, beginning each name with the same character string. By searching through all the program names for a specified character string, the program numbers and names of all programs having names including that string are listed.

The CNC programs within a specified group can also be output.

- Group-unit program list screen displayed when a search is made for "GEAR-1000*"

```

PROGRAM DIRECTORY (GROUP)          00001 N00010

          PROGRAM (NUM.)          MEMORY' CHAR.)
-USED:           60                3321
-FREE:           2                 429
00020 (GEAR-1000 MAIN)
00040 (GEAR-1000 SUB-1)
00200 (GEAR-1000 SUB-2)
02000 (GEAR-1000 SUB-3)

```

```

>_
EDIT ***** 16:53:25
[ PRGRM ][ DIR ][   ][   ][ (OPRT) ]

```

27.17 CLEARING THE SCREEN

When screen indication isn't necessary, the life of the back light for LCD can be put off by turning off the back light.

The screen can be cleared by pressing specific keys. It is also possible to specify the automatic clearing of the screen if no keys are pressed during a period specified with a parameter. (This cannot be performed for 160i/180i/210i/160is/180is/210is.)

But, the life of the back light may be contracted all the more when the clearing of screen and re-indication of screen are repeated beyond the necessity.

This effect can be expected when a screen is cleared for more than one hour.

27.18 PERIODIC MAINTENANCE SCREEN

The periodic maintenance screen shows the current statuses of those consumables that require periodic replacement (backup battery, LCD backlight, touch pad, etc.). An item whose service life has expired is indicated by the machine run time or the like.

```

PERIODICAL MAINTENANCE          00001 N12345
 (STATUS)
      ITEM NAME                REMAIN
* 01  BATTERY FOR CONTROLLER      0H
@ 02  BATTERY FOR PULSECODER     5000H
 03  LCD BACK LIGHT             10000H
@ 04  COOLANT                    720H
 05
 06
 07
 08
 09
 10
>_
EDIT **** * * * *                19:27:05
[          ] [MAINTE ] [          ] [          ] [(OPRT) ]

```

27.19 TOUCH PANEL

A pen input device/touch pad, manufactured by Fujitsu Limited, is used on the LCD display as follows:

- (1) The soft keys below the 10.4-inch color LCD/MDI panel (F0 to F9, FR, and FL) are replaced by the soft keys on the touch panel.
- (2) The cursor displayed on the 10.4-inch color LCD is controlled from the touch panel.
- (3) A touch-panel-type software machine operator's panel, realized by C executor, can be used.
- (4) A touch-panel-type calculator, realized by C executor, can be used.
- (5) A C executor application program can be created by using the touch panel.

27.20 EXTERNAL TOUCH PANEL INTERFACE

When this interface is supported, an external touch panel supporting the SNP-X protocol can be attached to the FANUC Series 16i/18i/21i (described just as the FS16 hereinafter).

With the external touch panel which has functions equivalent to the machine operator's panel, the PMC-controlled signals (input signals (X), output signals (Y), internal relays (R), keep relays (K), data tables (D), timers (T), and counters (C)) can be read and written.

The external touch panel features a plotting capability. The user can perform plotting and address (signal) assignment freely. For example, when a screen to which data table settings are assigned is created, data in the data table can be set using switches on the screen.

27.21 MAINTENANCE INFORMATION SCREEN

The history of the maintenance carried out by FANUC service personnel and machine tool builder can be recorded via the screen. The screen has the following features:

- Alphabetical characters can be input from MDI. (Half-size kana can be input only when Japanese display is selected.)
- The recording screen can be scrolled, line by line.
- Edited maintenance information can be read and punched.
- Data can be stored into flash ROM.
- Full-size (shift JIS) codes can be displayed. (Input codes are read only.)

27.22 COLOR SETTING SCREEN

When the VGA graphic control function is supported, the VGA screen colors can be set on the color setting screen.

COLORING				O0000 N00000			
[1]	■	·ALARM	8	■	·SELECT WINDOW BAR		
2	■	·TITLE ·SOFT KEY 1	9	■	·NONE		
3	■	·INPUT KEY ·O/N NO. ·STATUS	10	■	·TITLE BAR ·INPUT BAR		
4	■	·CURSOR	11	■	·WINDOW BACKGROUND		
5	■	·RESTART NO. ·ABSOLUTE ORDER	12	■	·LIGHT		
6	■	·SUB TITLE ·SOFT KEY 2	13	■	·ALTER POSSIBLE DATA		
7	■	·DATA ·TIME	14	■	·SHADOW		
			15	□	·BACKGROUND		
RED <input type="text" value="08"/> GREEN <input type="text" value="00"/> BLUE <input type="text" value="00"/>			COLOR SELECT NO. <input type="text" value="1 (PARAMETER)"/>				
[MEM **** * * * * 12:34:56]							
			COLOR			OPRT +	

27.23 CONTRAST ADJUSTMENT SCREEN

Some operators may find the LCD difficult to read, depending on their eye level relative to the display. To make a monochrome LCD easier to read, the contrast can be adjusted.

SETTING (HANDY)

```

PARAMETER WRITE =1 (0:DISABLE  1:ENABLE)
TV CHECK        =0 (0:OFF  1:ON)
PUNCH CODE      =0 (0:EIA  1:ISO)
INPUT UNIT      =0 (0:MM  1:INCH)
I/O CHANNEL     =0 (0-3:CHANNEL NO.)
SEQUENCE NO.    =0 (0:OFF  1:ON)
TAPE FORMAT     =0 (0:NO CNV  1:F15)
SEQUENCE STOP   =    0 (PROGRAM NO.)
SEQUENCE STOP   =    0 (SEQUENCE NO.)

```

```

CONTRAST        (+= [ON:1]  -= [OFF:0])

```

```
>
```

```
MDI **** * * * * BAT 00:00:00
```

```
[NO.SRH ] [ ON:1 ] [ OFF:0 ] [+INPUT ] [ INPUT ]
```

27.24 SETTING THE EMBEDDED ETHERNET FUNCTION

This section describes the screen used to set parameters for the embedded Ethernet function.

NOTE

With the series 20i-B, the “FACTOLINK function” and “DNC1/Ethernet function” are not operated. The “FOCAS1/Ethernet function” can communicate only with the following application software products. The function cannot communicate with any application software created by users using “FANUC Open CNC FOCAS1/Ethernet CNC/PMC Data Window Library.”

- Servo Guide
- FANUC LADDER-III
- Machine Remote Diagnosis Package

27.24.1 FACTOLINK Parameter Setting Screen

On the Ethernet parameter setting screen, set the parameters for operating the FACTOLINK function.

Display

Procedure

- 1 Place the CNC in the MDI mode.
- 2 Press the function key  .
- 3 Press the continuous menu key at the right end of the soft key display.
- 4 Press the [ETHPRM] soft key. The Ethernet parameter setting screen appears. The Ethernet functions currently available are displayed.



The upper row displays the usable embedded Ethernet function device.

The embedded port or PCMCIA card is displayed.



The lower row displays the usable Ethernet option boards. When no option board is installed, no information is displayed.

- 5 By pressing the [EMBEDD] soft key, the parameters for the embedded Ethernet port can be set.
By pressing the [PCMCIA] soft key, the parameters for the PCMCIA Ethernet card can be set.

NOTE

The parameters for the embedded Ethernet port and the parameters for the PCMCIA Ethernet card are independent of each other.

- 6 By using the MDI keys and soft keys, enter and update data.

- 7 Switch the screen display with the page keys  .

If data is already registered, the data is displayed.

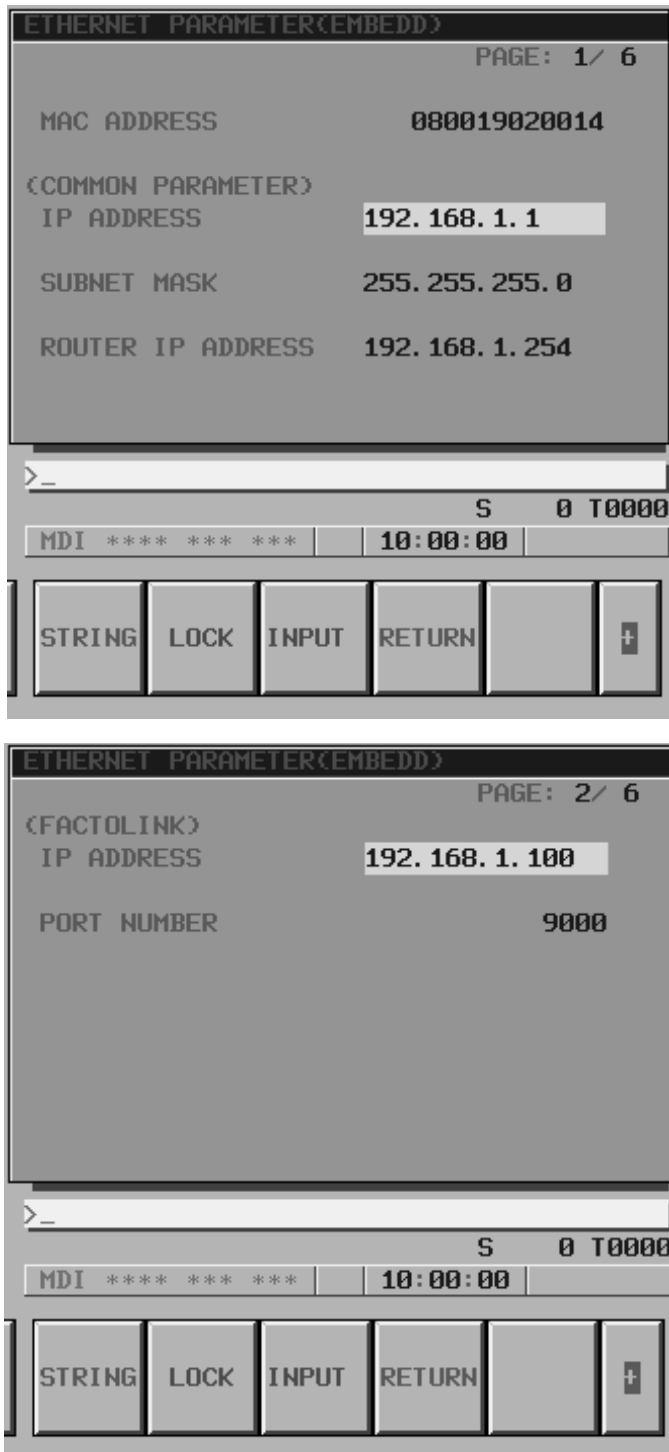

Display item and setting items

Display item related to the embedded Ethernet function

The item related to the embedded Ethernet function is displayed.

Item	Description
MAC ADDRESS	Embedded Ethernet MAC address

Embedded Ethernet TCP/IP setting items

Set the TCP/IP-related items of the embedded Ethernet.

Item	Description
IP ADDRESS	Specify the IP address of the embedded Ethernet. (Example of specification format: "192.168.1.1")
SUBNET MASK	Specify a mask address for the IP addresses of the network. (Example of specification format: "255.255.255.0")
ROUTER IP ADDRESS	Specify the IP address of the router. Specify this item when the network contains a router. (Example of specification format: "192.168.1.254")

FACTOLINK setting items

Set the items related to the host computer with which the FACTOLINK server operates.

Item	Description
IP ADDRESS	Specify the IP address of a personal computer to be accessed by the FACTOLINK function. (Example of specification format: "192.168.1.100")
PORT NUMBER	Specify a port number to be used with the FACTOLINK function. The valid input range is 5001 to 65535. A specified port number must match "ocsnc" of the "services" file of the personal computer. For details, refer to "FANUC FACTOLINK Script Function OPERATOR'S MANUAL (B-75054EN)".

27.24.2 FOCAS1/Ethernet Parameter Setting Screen

On the Ethernet parameter setting screen, set the parameters for operating the FOCAS1/Ethernet function.

NOTE

With the series 20i-B, the "FOCAS1/Ethernet function" can communicate only with the following application software products. The function cannot communicate with any application software created by users using "FANUC Open CNC FOCAS1/Ethernet CNC/PMC Data Window Library."

- Servo Guide
- FANUC LADDER-III
- Machine Remote Diagnosis Package

Display

Procedure

- 1 Place the CNC in the MDI mode.
- 2 Press the function key  .
- 3 Press the continuous menu key at the right end of the soft key display.
- 4 Press the [ETHPRM] soft key. The Ethernet parameter setting screen appears. The Ethernet functions currently available are displayed.



The upper row displays the usable embedded Ethernet function device.

The embedded port or PCMCIA card is displayed.



The lower row displays the usable Ethernet option boards. When no option board is installed, no information is displayed.

- 5 By pressing the [EMBEDD] soft key, the parameters for the embedded Ethernet port can be set.
By pressing the [PCMCIA] soft key, the parameters for the PCMCIA Ethernet card can be set.

NOTE

The parameters for the embedded Ethernet port and the parameters for the PCMCIA Ethernet card are independent of each other.

6 By using the MDI keys and soft keys, enter and update data.

7 Switch the screen display with the page keys   .

If data is already registered, the data is displayed.

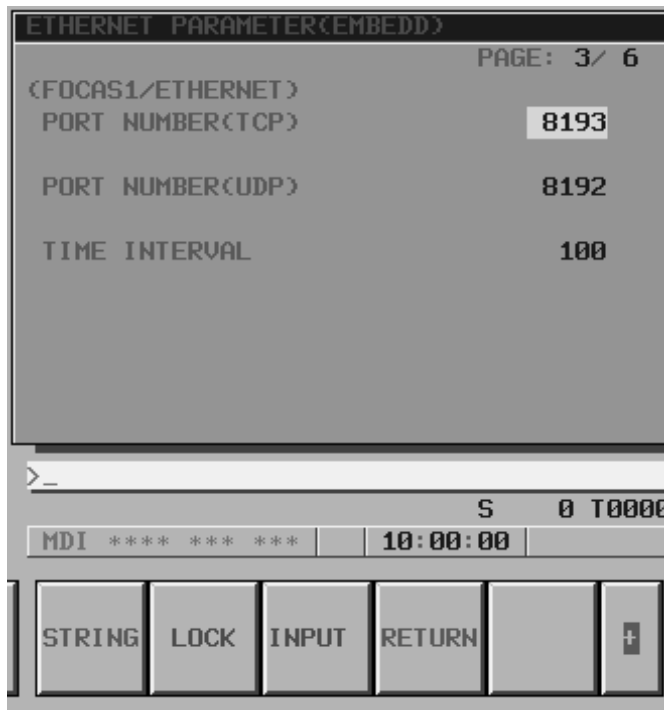
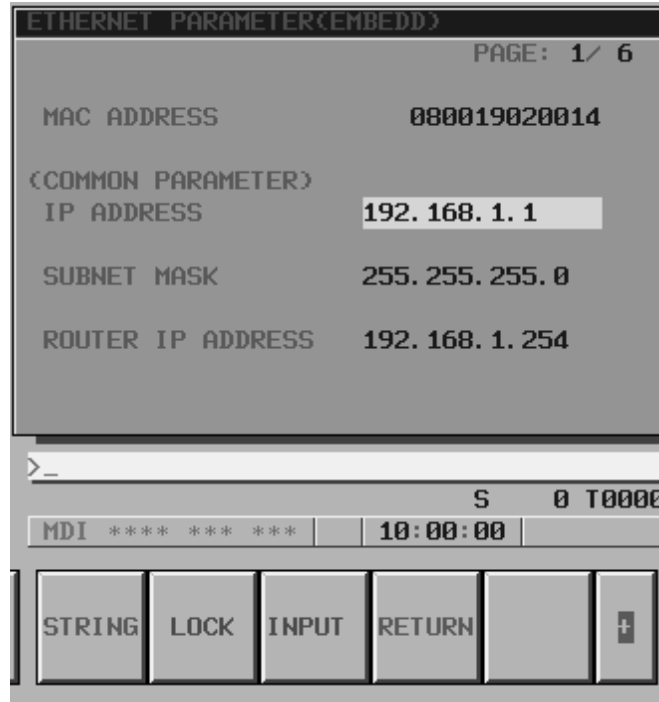

Display item and setting items

Display item related to the embedded Ethernet function

The item related to the embedded Ethernet function is displayed.

Item	Description
MAC ADDRESS	Embedded Ethernet MAC address

Embedded Ethernet TCP/IP setting items

Set the TCP/IP-related items of the embedded Ethernet.

Item	Description
IP ADDRESS	Specify the IP address of the embedded Ethernet. (Example of specification format: "192.168.1.1")
SUBNET MASK	Specify a mask address for the IP addresses of the network. (Example of specification format: "255.255.255.0")
ROUTER IP ADDRESS	Specify the IP address of the router. Specify this item when the network contains a router. (Example of specification format: "192.168.1.254")

FOCAS1/Ethernet setting items

Set the items related to the FOCAS1/Ethernet function.

Item	Description
PORT NUMBER (TCP)	Specify a port number to be used with the FOCAS1/Ethernet function. The valid input range is 5001 to 65535. When connecting to FANUC CIMPLICITY <i>i</i> CELL, refer to "FANUC CIMPLICITY <i>i</i> CELL OPERATOR'S MANUAL (B-75074EN)".
PORT NUMBER (UDP)	Set this item when connecting to FANUC CIMPLICITY <i>i</i> CELL. Specify a UDP port number for transmitting UDP broadcast data. The valid input range is 5001 to 65535. For details, refer to "FANUC CIMPLICITY <i>i</i> CELL OPERATOR'S MANUAL (B-75074EN)". Set 0 when using the FOCAS1/Ethernet function or when transmitting no UDP broadcast data.
TIME INTERVAL (NOTE 1)	Set this item when connecting to FANUC CIMPLICITY <i>i</i> CELL. Specify a time interval at which UDP broadcast data is transmitted as specified by the above UDP port number. The unit is 10 ms. The valid input range is 10 to 65535. This means that a value less than 100 ms cannot be specified. Set 0 when using the FOCAS1/Ethernet function or when transmitting no UDP broadcast data. Example) 100: Broadcast data is transmitted at intervals of one second [1000 ms] (= 100 × 10).

NOTE

- 1 When a small value is set for the item of time interval, communication load increases, and the performance of the network can be adversely affected.
- 2 The parameters for the PCMCIA Ethernet card are set to the following default values before shipment:

IP address:	192.168.1.1
Subnet mask:	255.255.255.0
Router IP address:	None
TCP port number:	8193
UDP port number:	0
Time interval:	0

27.24.3 FTP File Transfer Parameter Setting Screen

On the Ethernet parameter setting screen, set the parameters for operating the FTP file transfer function.

NOTE

The FTP file transfer function is usable with the control software for the embedded Ethernet function series 656A edition 02 or later and series 656V edition 01 or later.

Display

Procedure

- 1 Place the CNC in the MDI mode.
- 2 Press the function key  .
- 3 Press the continuous menu key at the right end of the soft key display.
- 4 Press the [ETHPRM] soft key. The Ethernet parameter setting screen appears. The Ethernet functions currently available are displayed.



The upper row displays the usable embedded Ethernet function device.

The embedded port or PCMCIA card is displayed.



The lower row displays the usable Ethernet option boards. When no option board is installed, no information is displayed.

- 5 By pressing the [EMBEDD] soft key, the parameters for the embedded Ethernet port can be set.
By pressing the [PCMCIA] soft key, the parameters for the PCMCIA Ethernet card can be set.

NOTE

The parameters for the embedded Ethernet port and the parameters for the PCMCIA Ethernet card are independent of each other.

6 By using the MDI keys and soft keys, enter and update data.

7 Switch the screen display with the page keys  .

If data is already registered, the data is displayed.

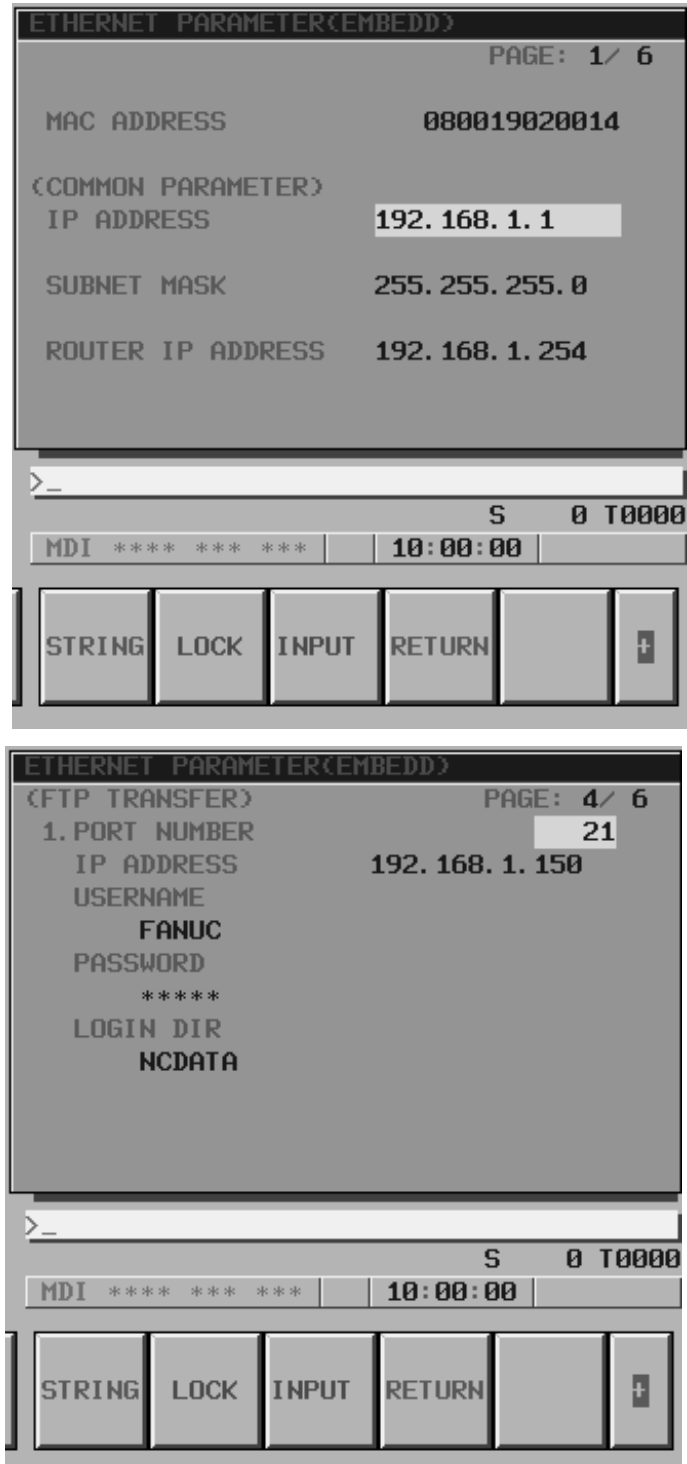

ETHERNET PARAMETER(EMBEDD)
PAGE: 1 / 6

MAC ADDRESS 080019020014

(COMMON PARAMETER)

IP ADDRESS 192.168.1.1

SUBNET MASK 255.255.255.0

ROUTER IP ADDRESS 192.168.1.254

>_

S 0 T0000

MDI ***** 10:00:00

STRING LOCK INPUT RETURN

ETHERNET PARAMETER(EMBEDD)
PAGE: 4 / 6

(FTP TRANSFER)

1. PORT NUMBER 21

IP ADDRESS 192.168.1.150

USERNAME FANUC

PASSWORD *****

LOGIN DIR NCDATA

>_

S 0 T0000

MDI ***** 10:00:00

STRING LOCK INPUT RETURN

Display item and setting items

Display item related to the embedded Ethernet function

The item related to the embedded Ethernet function is displayed.

Item	Description
MAC ADDRESS	Embedded Ethernet MAC address

Embedded Ethernet TCP/IP setting items

Set the TCP/IP-related items of the embedded Ethernet.

Item	Description
IP ADDRESS	Specify the IP address of the embedded Ethernet. (Example of specification format: "192.168.1.1")
SUBNET MASK	Specify a mask address for the IP addresses of the network. (Example of specification format: "255.255.255.0")
ROUTER IP ADDRESS	Specify the IP address of the router. Specify this item when the network contains a router. (Example of specification format: "192.168.1.254")

FTP file transfer setting items

Make settings related to the FTP file transfer function.
Settings for up to three host computers can be made.

Item	Description
PORT NUMBER	Specify a port number to be used with the FTP file transfer function. An FTP session is used, so that "21" is to be specified usually.
IP ADDRESS	Specify the IP address of the host computer. (Example of specification format: "192.168.1.150")
USERNAME	Specify a user name to be used for logging in to the host computer with FTP. (Up to 31 characters can be specified.)
PASSWORD	Specify a password for the user name specified above. Be sure to set a password. (Up to 31 characters can be specified.)
LOGIN DIR	Specify a work directory to be used when logging in to the host computer. (Up to 127 characters can be specified.)

27.25 ID INFORMATION SCREEN

Overview

When the αi servo or αi spindle is connected, if each of the units (motor or amplifier) actually connected it has ID information, the ID information can be read and displayed on the CNC screen.

27.25.1 αi Servo Information Screen

Displaying the servo ID screen

```

SERVO INFORMATION                00000 N00000

  X AXIS
SERVO MOTOR SPEC A06B-0268-B100
SERVO MOTOR S/N  C00ZB1111
PULSECODER SPEC. A860-2000-T301
PULSECODER S/N   00000001
SERVO AMP SPEC.  A06B-6114-H211
SERVO AMP S/N    V01311111
PSM SPEC.        A06B-6087-H126#000001
PSM S/N          V01311111

MDI **** * 19:12:26
(SYSTEM){SV-INF}{SP-INF}{ }

```

* If no servo information is recorded, servo information is automatically stored in flash ROM. On the screen, if there is a difference between the servo information in flash ROM and the actual servo information, the corresponding items are preceded by *, as shown below. This allows you to determine whether the configuration of connected units is changed. At this time, the servo information is read from flash ROM.

```

SERVO INFORMATION                00000 N00000

  X AXIS
SERVO MOTOR SPEC A06B-0268-B100
SERVO MOTOR S/N  C00ZB1111
PULSECODER SPEC. A860-2000-T301
PULSECODER S/N   00000001
*SERVO AMP SPEC. A06B-6114-H211
*SERVO AMP S/N    V01311111
PSM SPEC.        A06B-6087-H126#000001
PSM S/N          V01311111

} _
MDI **** * 19:12:26
(SYSTEM){SV-INF}{SP-INF}{ }{(OPRT) }

```

Editing the servo ID screen

The servo information recorded or stored in flash ROM can also be edited. See Chapter 9 "Digital Servo" in the Maintenance Manual (B-63525EN).

27.25.2

*α*i Spindle Information Screen

Displaying the spindle ID screen

```

SPINDLE INFORMATION                00000 N00000

  S1
  SP MOTOR SPEC      A06B-0852-B088#0007
  SP MOTOR S/N      C99XA1234

  SP AMP SPEC      A06B-6102-H106#H520CE
  SP AMP S/N      V0020090601
  PSM SPEC.      A06B-6087-H126#000001
  PSM S/N      V0020031702

} _
MDI **** * 19:12:05
{SYSTEM}{SV-INF){SP-INF){ } }

```

* If no spindle information is recorded, spindle information is automatically stored in flash ROM. On the screen, if there is a difference between the spindle information in flash ROM and the actual spindle information, the corresponding items are preceded by *, as shown below. This allows you to determine whether the configuration of connected units is changed. At this time, the spindle information is read from flash ROM.

```

SPINDLE INFORMATION                00000 N00000

  S1
  SP MOTOR SPEC      A06B-0852-B088#0007
  SP MOTOR S/N      C99XA1234

*SP AMP SPEC      A06B-6102-H106#H520CE
*SP AMP S/N      V0020090601
  PSM SPEC.      A06B-6087-H126#000001
  PSM S/N      V0020031702

} _
MDI **** * 19:12:05
{SYSTEM}{SV-INF){SP-INF){ } }

```

Editing the spindle ID screen

The spindle information recorded or stored in flash ROM can also be edited.

See Chapter 10 "Spindle" in the Maintenance Manual (B-63525EN).

28 PART PROGRAM STORAGE AND EDITING



28.1 FOREGROUND EDITING

The following part program storage and editing is possible

- **Program tape registration to the memory**
 - Single program registration
 - Multi program tape registration
- **Program input via MDI**
- **Program deletion**
 - Single program deletion
 - All programs deletion
 - Multi programs deletion by specification the range
- **Program punching**
 - Single program punching
 - All programs punching
 - Multi programs punching by specification the range
- **Program editing**
 - Change
 - Word change
 - Change of 1-word to multi-words
 - Insertion
 - Word insertion
 - Multi words, and multi blocks insertion
 - Deletion
 - Word deletion
 - Deletion to EOB
 - Deletion to the specified word
- **Part program collation**

Collation of program stored in the memory and program on the tape can be done.
- **Sequence number automatic insertion**

The sequence number, where a certain increment value is added to the sequence number of the previous block can be automatically inserted at the head of each block in preparation of programs by the part program editing.

The initial value of sequence number and a certain increment amount can be set.

28.2 BACKGROUND EDITING

Part program storage and editing can be done during machining. The same functions as foreground editing can be performed. However, it is not possible to delete all programs at one time.

28.3 EXPANDED PART PROGRAM EDITING

The following editing is possible.

- **Conversion**
 - Address conversion
An address in the program can be converted to another address. For example address X in the program can be converted to address Y.
 - Word conversion
A word in the program can be converted to another word. For example, a programmed M03 can be converted to M04.
- **Program copy**
A part or all of a program can be copied to make a new program.
- **Program move**
A part or all of a program can be moved to make a new program.
- **Program merge**
A new program can be created by merging two programs.
- **Editing in the key-in buffer**
A word starting from the current cursor position or words up to an EOB can be copied and moved from the program to key-in buffer. In addition, characters input in the key-in buffer can be edited.

28.4 NUMBER OF REGISTERED PROGRAMS

Number of registered programs can be selected from the following: 63, 125, 200, 400, or 1000.

28.5 PART PROGRAM STORAGE LENGTH

The following part program storage length can be selected: 10, 20, 40, 80, 160, 320, 640, 1280, 2560, or 5120 m.

28.6 PLAY BACK

Program can be prepared by storing machine position obtained by manual operation in the memory as program position. Data other than the coordinate value (M codes, G codes, feed rates, etc.) are registered in the memory by the same operation as part program storage and editing.

28.7 EXTERNAL CONTROL OF I/O DEVICE

Part program registration and punch can be commanded externally.

- **Program registration**
A part program can be registered in memory through the connected input device for background editing using the external read start signal.
- **Program punch**
A part program can be punched through the connected output device for background editing using the external punch start signal.

28.8 CONVERSATIONAL PROGRAMMING OF FIGURES (ONLY AT 1-PATH CONTROL)

The following two screens can be displayed with graphic data for guidance in programming in the CNC format:

- G code list
- Standard format of a G-code block

Programs can be created by referring to guidelines and entering necessary data interactively.

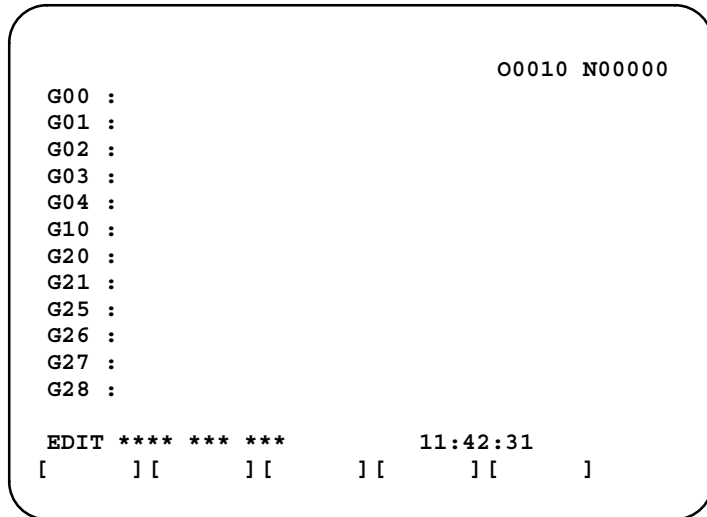

↓ When G01 is selected

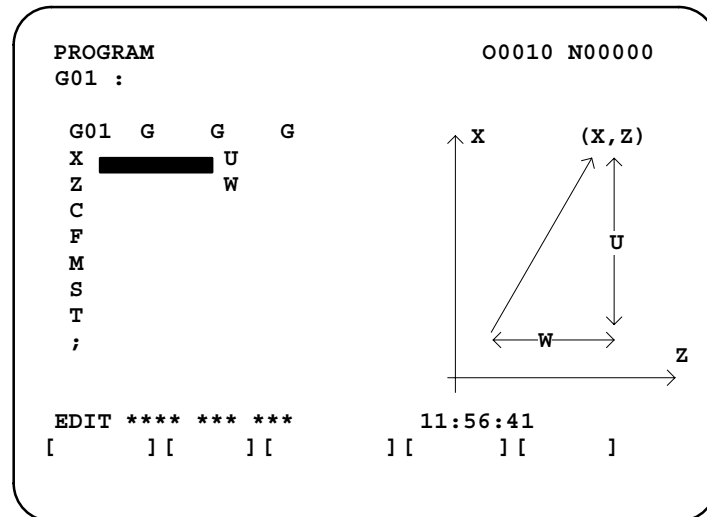

28.9 PASSWORD FUNCTION

The password function (parameter NE9) can be locked using parameter PASSWD and parameter KEYWD to protect program Nos. 9000 to 9999. In the locked state, parameter NE9 cannot be set to 0. In this state, program Nos. 9000 to 9999 cannot be modified unless the correct keyword is set.

A locked state means that the value set in the parameter PASSWD differs from the value set in the parameter KEYWD. The values set in these parameters are not displayed. The locked state is released when the value already set in the parameter PASSWD is also set in parameter KEYWD. When 0 is displayed in parameter PASSWD, parameter PASSWD is not set.

29

DIAGNOSIS FUNCTIONS



29.1 SELF DIAGNOSIS FUNCTIONS

The CNC checks the following itself.

- Abnormality of detection system
- Abnormality of position control unit
- Abnormality of servo system
- Overheat
- Abnormality of CPU
- Abnormality of ROM
- Abnormality of RAM
- Abnormality in data transfer between MDI
- Abnormality of part program storage memory
- Abnormality in tape reader read function
- Abnormality in data transfer between PMC

The CNC also checks other items.

Input/output signals from PMC to CNC, or vice versa, and inner status of the CNC can be displayed.

30 DATA INPUT/OUTPUT

The NC has the following input/output data.

These data are input/output via various input/output devices as CRT/MDI, tape reader, etc.

- **Input data**

The NC has the following input data.

- Part program
- Tool compensation amount and Work zero point offset value
- Tool life management data
- Setting data
- Custom macro common variable
- Pitch error compensation data
- Parameters

- **Output data**

The NC has the following output data.

- Part program
- Tool compensation amount and work zero point offset value
- Setting data
- Custom macro common variable
- Pitch error compensation data
- Parameters

30.1 READER/PUNCH INTERFACES

The following can be input/output via the reader/punch interface.

- Part program registration/output
- Tool offset amount, work zero point offset amount, input/output
- Tool life management data input
- Custom macro common variable input/output
- Pitch error compensation data input/output
- Parameter punch input/output

Usually, the screen is switched according to the type of data to be input from or output to an external device; for example, a parameter screen is used for parameter input/output, and a program screen is used for program input/output. However, a single ALL I/O screen can be used to input and output programs, parameters, offset data, and macro variables.

30.2 INPUT/OUTPUT DEVICES

The following Input/Output devices are prepared, which are connectable to the reader/puncher interface.

30.2.1 FANUC Floppy Cassette

When the Floppy Cassette is connected to the NC, machining programs stored in the NC can be saved on a Floppy Cassette, and machining programs saved in the Floppy Cassette can be transferred to the NC.

30.2.2 FANUC Program File Mate

The built-in hard disk enables data to be stored and it can be connected to the reader/puncher interface to input data to CNC. This hard disk has a large storage capacity of approximately 50,000 m of paper tape data, so it can register maximum 1024 command programs.

It can be connected to the remote buffer to achieve high-speed transfer of maximum 86.4 kbps.

The hard disk is sealed to be continuously used under the factory environment.

30.2.3 FANUC Handy File

The FANUC Handy File is a compact multi functional input/output floppy disk unit for use with various types of FA equipment. Programs can be transferred or edited through operations performed directly on the Handy File or through remote operation from connected equipment.

Compared with media such as paper tape, a 3.5" floppy disk is both compact and durable, and eliminates noise during input/output. Programs with a total capacity of up to 1.44 MB (equivalent to about 3600 m paper tape) can be saved on a single floppy disk.

30.3 EXTERNAL PROGRAM INPUT

By using the external program input start signal, a program can be loaded from an input unit into CNC memory.

When an input unit such as the FANUC Handy File or FANUC Floppy Cassette is being used, a file can be searched for using the workpiece number search signals, after which the program can be loaded into CNC memory.

30.4 DATA INPUT/OUTPUT USING A MEMORY CARD

Files on a memory card can be referenced, and different types of data such as part programs, parameters, and offset data on a memory card can be input and output in text file format.

The major functions are listed below.

- **Displaying a directory of stored files**
The files stored on a memory card can be displayed on the directory screen.
- **Searching for a file**
A search is made for a file on a memory card and, if found, it is displayed on the directory screen.
- **Reading a file**
Text-format files can be read from a memory card.
- **Writing a file**
Data such as part programs can be stored to a memory card in text file format.
- **Deleting a file**
A file can be selected and deleted from a memory card.

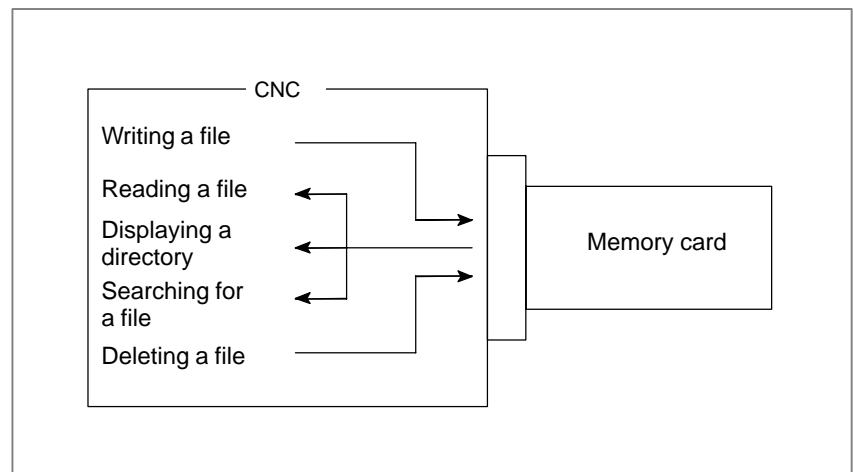

NOTE

For the 160i/180i/210i/160is/180is/210is, use the CNC screen display function.

30.5 SCREEN HARD COPY

Screen information displayed on the CNC can be output to a memory card in a bit-mapped format. In this case, however, only still picture information can be output. Bit-mapped data created by this function can be displayed on a Windows personal computer and so forth.

To take a hard copy of a screen, set a memory card in the CNC, then hold down the  key for five seconds or set hard copy start signal HDREQ (G67 #7) to 1. In several seconds to several tens seconds until hard copy operation completes, a still picture is displayed on the screen.

The number of colors of a created bit-mapped format file depends on the display control card, LCD hardware, and the display mode of the CNC screen. The relationships are listed in Table 30.5 (a).

Table 30.5 (a) Number of colors of bit-mapped format files created by screen hard copy

	LCD hardware	CNC screen display mode	Number of colors displayed on CNC	Number of colors in BMP data	Remarks
VGA card	Monochrome	—	2 colors	2 colors	Monochrome gradation is not supported.
	Color	VGA compatible mode	Characters: 16 colors Graphic: 16 colors	Parameter - No.3301#0=0 →256 colors Parameter - No.3301#0=1 →16 colors	Ordinary CNC screen is displayed. If parameter No.3301#0 is 1, colors may differ from the screen display.
		VGA mode	256 colors	256 colors	Screen that can be prepared using C executor.

Table 30.5 (b) shows the data sizes of bit-mapped format files.

Table 30.5 (b) Number of colors and data size of bit-mapped format files

Number of colors in bit map	File size (bytes)
Monochrome (2 colors)	38,462
Color (16 colors)	153,718
Color (256 colors)	308,278

NOTE

For the 160i/180i/210i/160is/180is/210is, this function is disabled.

30.6 DNC1 CONTROL

DNC1 is a network originally developed by FANUC. Personal computer FA supports a connection mode called mode 1 of DNC1. This mode allows multi-point communication in which the personal computer functions as a primary station to control multiple NCs. In personal computer FA, up to 16 NCs can be connected to a single personal computer. For details, refer to "Personal Computer FA System Operator's Manual (B-75044EN)."

Connection example

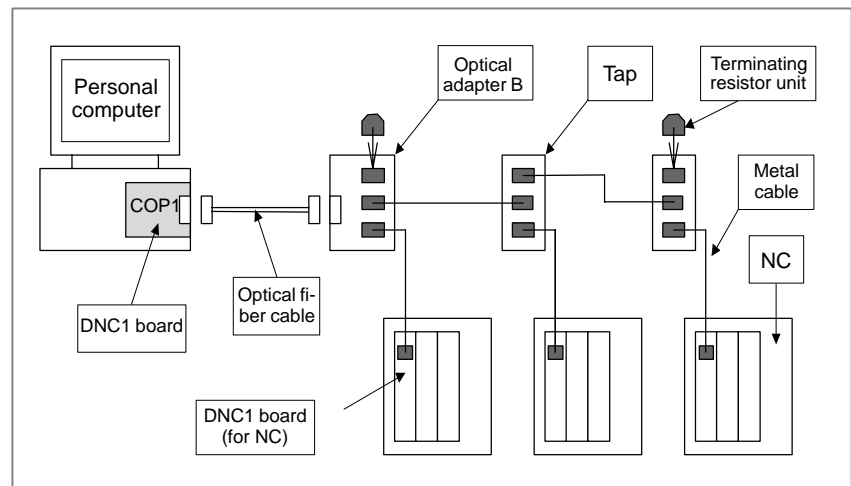

When three NCs and a personal computer are connected via optical adapter B

User applications created using the FA library of personal computer FA can perform the following processing:

- ◆ NC program file downloading started from the personal computer
- ◆ NC program file uploading started from the personal computer
- ◆ External reset
- ◆ Selection and deletion of NC programs
- ◆ Read of NC directory information
- ◆ Read of alarm information
- ◆ Read and write of tool offset values
- ◆ Read and write of custom macro variables
- ◆ Read of tool life management data
- ◆ Read and write of PMC data
- ◆ Read of NC identification information
- ◆ Read and write of NC parameters
- ◆ Notification of the start and end of NC program file downloading and uploading started by an NC

30.7 DNC2 CONTROL (ONLY AT 1-PATH CONTROL)

The FANUC DNC2 is a communication protocol enabling data transmission between the FANUC CNC unit and a personal computer by connecting them via the RS-232C interface.

The FANUC DNC2 has the following features:

- (1) This protocol is based on the communication protocol LSV2 used by some CNC manufacturers in Europe, so that software can easily be established even with a personal computer.

The RS-232C interface is used to connect a personal computer with the FANUC CNC. The RS-422 interface can also be used to improve the transmission rate.

- (2) This protocol is used for one-to-one (point-to-point) communication between one FANUC CNC unit and one personal computer.

The protocol cannot provide multi-point communication between one personal computer and more than one CNC unit.

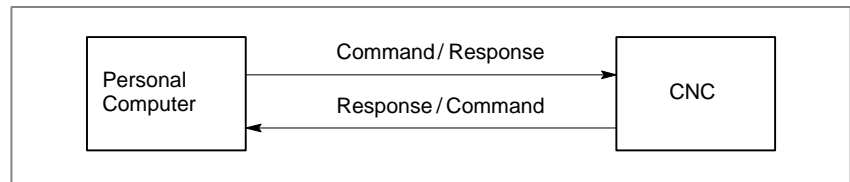

30.8 ETHERNET FUNCTION (OPTION BOARD)

When an option board (the Ethernet board or data server board) is used, the following Ethernet functions are available:

When the Ethernet board is used

- FOCAS1/Ethernet function
- DNC1/Ethernet function
- FACTOLINK function

When the data server board is used

- FOCAS1/Ethernet function
- DNC1/Ethernet function
- FACTOLINK function
- Data server function

These functions can be used together at the same time.

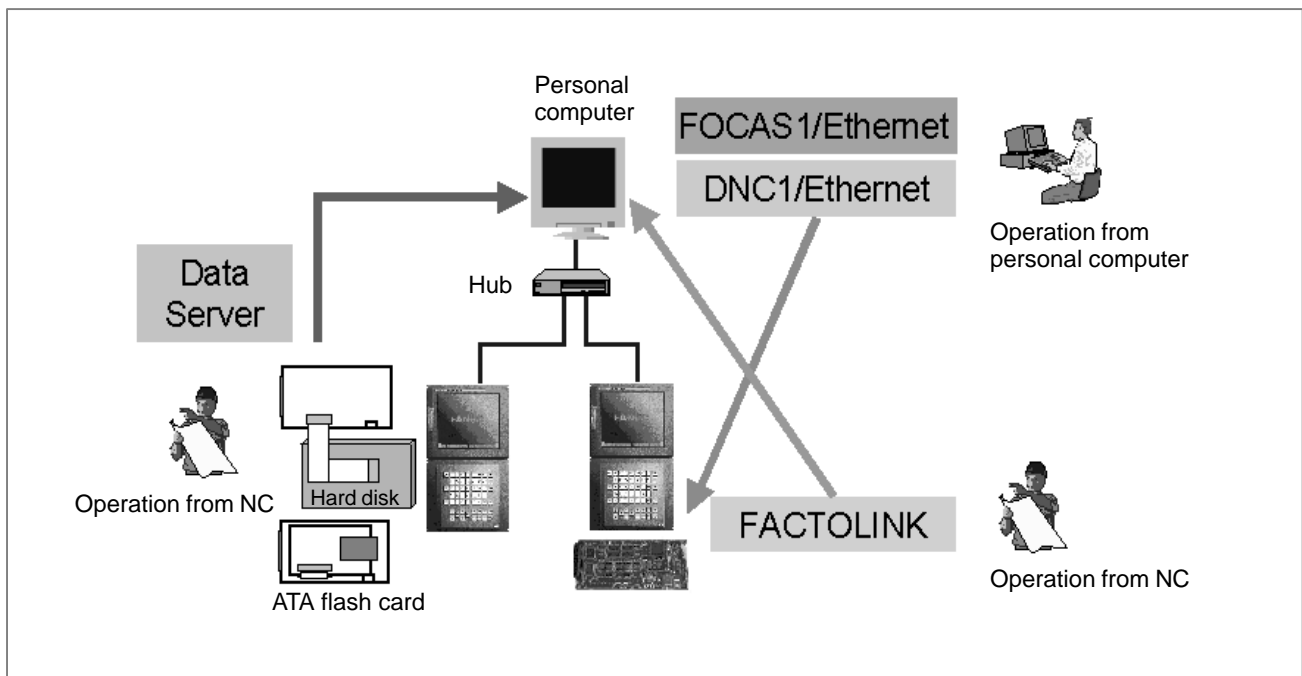

NOTE

- 1 An Ethernet board and a data server board cannot be installed at the same time.
- 2 With the series 20i-B, the "FACTOLINK function" and "DNC1/Ethernet function" are not operated. The "FOCAS1/Ethernet function" can communicate only with the following application software products. The function cannot communicate with any application software created by users using "FANUC Open CNC FOCAS1/Ethernet CNC/PMC Data Window Library."
 - Servo Guide
 - FANUC LADDER-III
 - Machine Remote Diagnosis Package
- 3 The Series 20i-B does not support data server boards.

30.8.1 FOCAS1/Ethernet Function

The FOCAS1/Ethernet function allows remote control and monitoring of CNCs from the personal computer. This function can transfer a wider range of NC data than the DNC1/Ethernet function.

For details, refer to "Ethernet Board/DATA SERVER Board Operator's Manual (B-63354EN)" and "FANUC Open CNC FOCAS1/Ethernet CNC/PMC Data Window Library Description."

NC data transfer

The following NC data can be transferred by operation on the personal computer:

- Data related to controlled axes and spindles
 - Absolute position, relative position, machine position
 - Remaining travel distance
 - Actual feedrate
- NC program
- Directory information in part program storage
- NC file data
 - Parameters
 - Tool offset values
 - Custom macro variables
 - Workpiece zero point offset values
 - Settings
 - P code macro variables
 - Pitch error compensation data
- Tool life management data
- History data
 - Operation history data
 - Alarm history data
- Data related to servo systems and spindles
- Data related to profile diagnosis
- Modal data
- Diagnostic data
- A/D conversion data
- Alarm information
- NC system identification information
- PMC data
 - Addresses G, F, Y, X, A, R, T, K, C, D
 - Extended hold type data

Remote control

The following operations can be performed by operation on the personal computer:

- Selecting NC programs
- Deleting NC programs
- External reset

Operation

The following operation can be performed by operation on the personal computer:

- DNC operation

30.8.2 DNC1/Ethernet Function

The DNC1/Ethernet function allows remote control and monitoring of CNCs from the personal computer. This function provides a software library having a simpler function call format than the FOCAS1/Ethernet function.

For details, refer to "Ethernet Board/DATA SERVER Board Operator's Manual (B-63354EN)" and "FANUC Personal Computer FA System Windows NT Version Operator's Manual (B-75044EN)."

NC data transfer

The following NC data can be transferred by operation on the personal computer:

- NC programs
- Directory information in part program storage
- NC file data
 - Parameters
 - Tool offset values
 - Custom macro variables
- Alarm information
- NC system identification information
- PMC data
 - Addresses G, F, Y, X, A, R, T, K, C, D

Remote control

The following operations can be performed by operation on the personal computer:

- Selecting NC programs
- Deleting NC programs
- External reset

Operation

The following operation can be performed by operation on the personal computer:

- DNC operation

30.8.3 FACTOLINK Function

With the FACTOLINK function, the user can operate a CNC to display information such as operation instructions on the CNC screen and transfer NC data.

For details, refer to "Ethernet Board/DATA SERVER Board Operator's Manual (B-63354EN)" and "FANUC FACTOLINK Script Function Operator's Manual (B-75054EN)."

Screen display

Information created on the personal computer such as operation instructions can be displayed on the NC screen by operation on an NC.

NC data transfer

The following NC data can be transferred by operation on the personal computer:

- NC programs
- NC file data
 - Parameters
 - Ladder programs
 - C executor execution form
 - Macro executor execution form
 - NC system files
- PMC data
 - Addresses T, K, C, D

Logging

The machine status can be posted automatically to the personal computer.

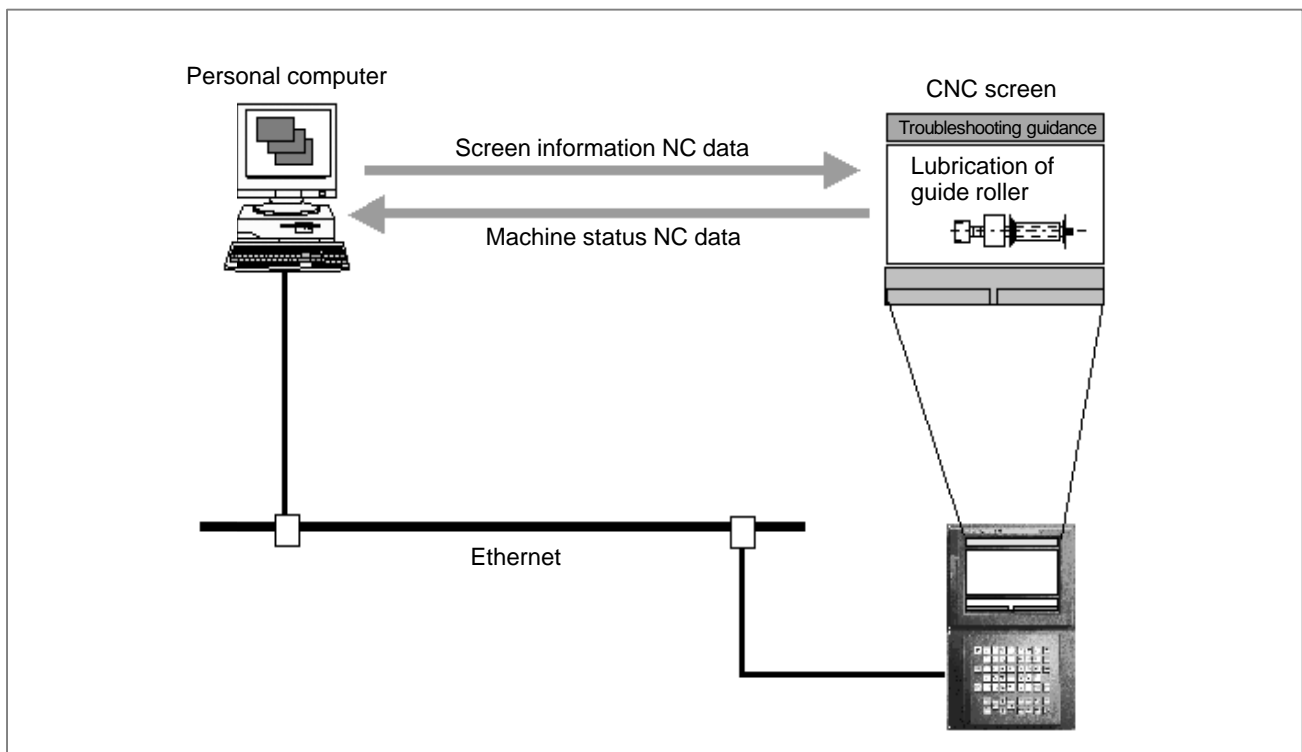

30.8.4 Data Server Function

The data server function can perform NC data transfer and DNC operation by using FTP.

The data server function operates mainly as an FTP client. It also operates as an FTP server.

The data server function uses the ATA flash card included in (attached to) the data server board as an NC data storage area. For details, refer to "Ethernet Board/DATA SERVER Board Operator's Manual (B-63354EN)."

NC data transfer (between the personal computer and the hard disk on the data server board] <FTP client>

By operation on an NC, this function is operated as an FTP client and provides the following services:

- GET
- MGET
- PUT
- MPUT
- DIR
- DEL

NC data transfer [between the personal computer and the hard disk on the data server board] <FTP server>

By operation on the personal computer, the function is operated as an FTP server and provides the following services:

- GET
- MGET
- PUT
- MPUT
- DIR
- DEL

NC data transfer [between the hard disk on the data server board and part program storage]

The following NC data can be transferred by operation on an NC:

- NC programs
- NC file data
 - Parameters
 - Tool offset values
 - Custom macro variables
 - Workpiece zero point offset values
 - Pitch error compensation data
 - M code group (for the Series 16i/18i-A only)
- History data
 - Operation history data

Operation [between the hard disk on the data server board and part program storage]

The following operations can be performed by operation on an NC:

- DNC operation
- DNC operation by subprogram call (M198)

Operation [between the personal computer and part program storage]

The following operations can be performed by operation on an NC:

- DNC operation
- DNC operation by subprogram call (M198)

Hard disk management

Hard disk management can be performed by operation on an NC.

- Hard disk formatting
- Hard disk check
- Display of a list of files on the hard disk

30.9 EMBEDDED ETHERNET FUNCTION

30.9.1 Embedded Ethernet and PCMCIA Ethernet

The embedded Ethernet function can be used by selecting one of two types of devices: the embedded Ethernet port and PCMCIA Ethernet card.

The PCMCIA Ethernet card is to be inserted into the memory card slot to the left of the front LCD for temporary communication.

NOTE

- 1 Use the PCMCIA Ethernet card for temporary communication only. Do not use the PCMCIA Ethernet card for routine communication.
- 2 The PCMCIA Ethernet card is to be inserted into the memory card slot to the left of the LCD. This means that some part of the card is projected. When using the PCMCIA Ethernet card, be careful not to damage the card by hitting the card with an object.
After using the PCMCIA Ethernet card, remove the card immediately to prevent the card from being damaged.
- 3 With Series 21*i*/20*i*/210*i*/210*is*-B, the embedded Ethernet port cannot be used.
- 4 As for "PCMCIA Ethernet card" to describe here, it is described about the case that it was inserted into Series 16*i*/18*i*/21*i*/20*i*-B.
When PCMCIA Ethernet card is inserted into Series 160*i*/180*i*/210*i*/160*is*/180*is*/210*is*-B, PCMCIA Ethernet card does not become embedded Ethernet.

30.9.2 List of Functions

With the embedded Ethernet function, the following functions can be operated:

- FACTOLINK function
- FOCAS1/Ethernet function
- DNC1/Ethernet function
- FTP file transfer function

NOTE

With the series 20i-B, the “FACTOLINK function” and “DNC1/Ethernet function” are not operated. The “FOCAS1/Ethernet function” can communicate only with the following application software products. The function cannot communicate with any application software created by users using “FANUC Open CNC FOCAS1/Ethernet CNC/PMC Data Window Library.”

- Servo Guide
- FANUC LADDER-III
- Machine Remote Diagnosis Package

30.9.2.1 FACTOLINK function

With the FACTOLINK function, data can be displayed on the CNC screen, and NC data can be transferred by operations on the NC. For details, refer to “FANUC FACTOLINK Script Function OPERATOR’S MANUAL (B-75054EN)”.

NOTE

The FACTOLINK function is usable with the control software for the embedded Ethernet function series 656A edition 02 or later and series 656V edition 01 or later.

Screen display

Data created by a personal computer can be displayed on the NC screen by operations on the NC.

NC data transfer

The following NC data can be transferred by operations on the NC:

- NC program
- NC file data
 - Parameter
 - Ladder program
 - C language executor in executable form
 - Macro executor in executable form
 - NC system file
- PMC data
 - Addresses T, K, C, D

Logging

Machine state information can be automatically sent to the personal computer.

30.9.2.2 FOCAS1/Ethernet function

The FOCAS1/Ethernet function allows a personal computer to remotely control and monitor the CNC. The FOCAS1/Ethernet function can transfer a wider range of NC data than the DNC1/Ethernet function. For details, refer to "FANUC Open CNC FOCAS1/Ethernet CNC/PMC Data Window Library Description".

NC data transfer

The following NC data can be transferred by operations on the personal computer:

- Data related to control axes/spindles
 - Absolute position
 - Relative position
 - Machine position
 - Remaining travel amount
 - Actual speed
- NC program
- Part program storage directory information
- NC data file
 - Parameter
 - Tool offset value
 - Custom macro variable
 - Workpiece origin offset
 - Setting data
 - P code macro variable
 - Pitch error compensation
- Tool life management data
- History data
 - Operation history data
 - Alarm history data
- Servo-/spindle-related data
- Data related to waveform diagnosis
- Modal data
- Diagnosis data
- A/D conversion data
- Alarm information
- NC system identification information
- PMC data
 - Addresses G, F, Y, X, A, R, T, K, C, D
 - Extended nonvolatile data

Remote operation

From the personal computer, the following operations can be performed:

- NC program selection
- NC program deletion
- External reset

NOTE

With the FOCAS1/Ethernet function of the embedded Ethernet function, DNC operation cannot be performed.

**30.9.2.3
DNC1/Ethernet function**

The DNC1/Ethernet function allows a personal computer to remotely control and monitor the CNC. The DNC1/Ethernet function provides software libraries in a simpler function call format when compared with the FOCAS1/Ethernet function.

For details, refer to "FANUC Personal Computer FA System Windows NT Version OPERATOR'S MANUAL (B-75044EN)".

NC data transfer

The following NC data can be transferred by operations on the personal computer:

- NC program
- Part program storage directory information
- NC file data
 - Parameter
 - Tool offset value
 - Custom macro variable
- Alarm information
- NC system identification information
- PMC data
 - Addresses G, F, Y, X, A, R, T, K, C, D

Remote operation

From the personal computer, the following operations can be performed:

- NC program selection
- NC program deletion
- External reset

NOTE

With the DNC1/Ethernet function of the embedded Ethernet function, DNC operation cannot be performed.

Differences between the FOCAS1/Ethernet function and DNC1/Ethernet function

Compared with the FOCAS1/Ethernet function, the DNC1/Ethernet function provides software libraries in a simpler function call format for frequently used functions.

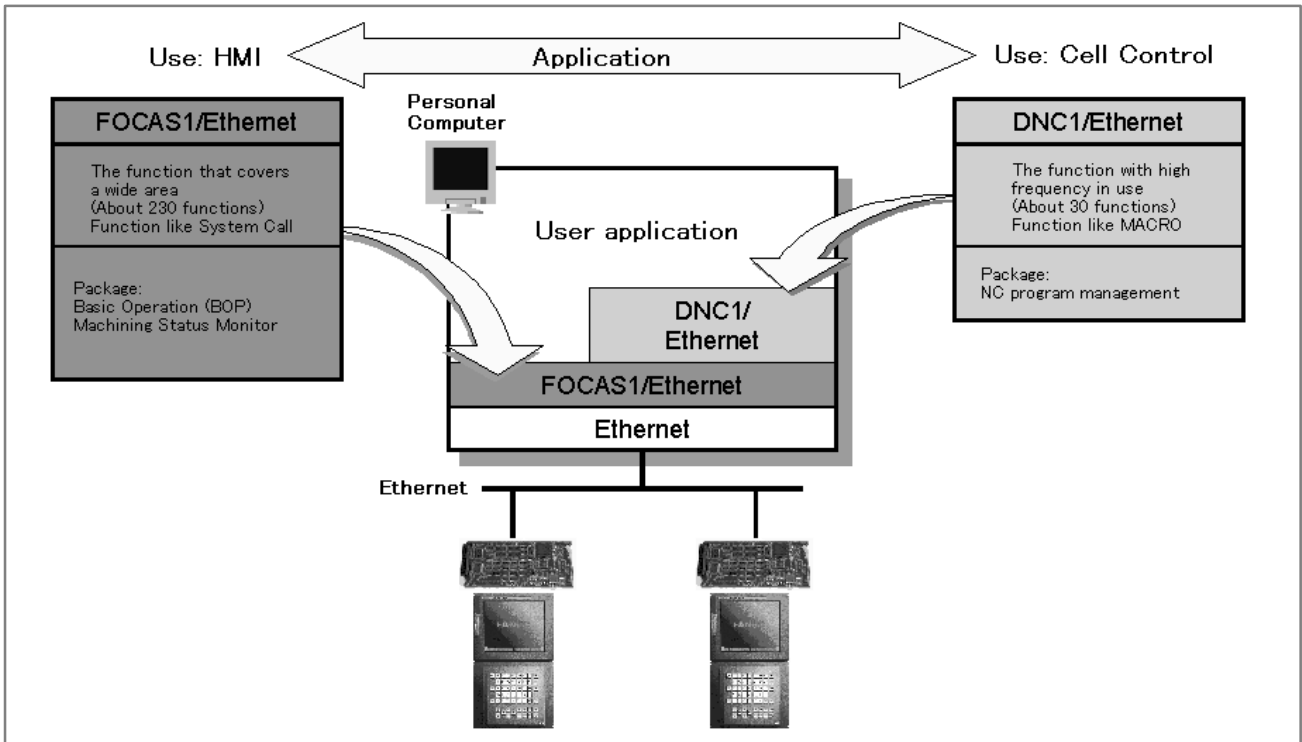

30.9.2.4 FTP file transfer function

The FTP file transfer function transfers files with FTP. The function can read and punch NC programs and various types of NC data.

NOTE

The FTP file transfer function is usable with the control software for the embedded Ethernet function series 656A edition 02 or later and series 656V edition 01 or later.

NC data transfer [Personal computer ↔ Part program storage]

The following NC data can be transferred by operations on the NC:

- NC program
- NC file data
 - Parameter
 - Tool offset value
 - Workpiece origin offset value
 - Pitch error compensation
 - M code group (Series 16i/18i/160i/180i/160is/180is-B only)
- History data
 - Operation history data

30.9.2.5 Functional differences between the embedded Ethernet function and the Ethernet function based on the option board

The table below indicates the differences between the embedded Ethernet function and the Ethernet function based on the option board.

	Embedded Ethernet	Option board
FOCAS1/Ethernet function	Available	Available
CNC screen display function	Not available	Available
DNC operation	Not available	Available
Data Server function	Not available(NOTE 1)	Available
FACTOLINK function	Available	Available

NOTE

- 1 The embedded Ethernet function includes the FTP file transfer function.

This function is almost equivalent to the NC data transfer function in the FTP mode of the Data Server function of the option board.

- 2 Compared with the option board, the embedded Ethernet function allows a smaller number of FOCAS1/Ethernet clients to be connected simultaneously.

	Embedded Ethernet	Ethernet board	Fast Ethernet board
Number of clients that can be connected simultaneously	5 clients maximum	10 clients maximum	20 clients maximum
Number of personal computers that can be connected simultaneously	1 unit (recommended)	10 units maximum	20 units maximum

- 3 Communications using the embedded Ethernet function is processed by the CPU of the CNC. This means that the operation state of the CNC can affect the performance of communication based on the embedded Ethernet function, and communication based on the embedded Ethernet function can affect the processing of the CNC.

The embedded Ethernet function has lower priority than axis-by-axis processing such as automatic operation processing and manual operation. So, when automatic operation is being performed or many controlled axes are involved, communication may become slower.

On the contrary, the embedded Ethernet function has higher priority over CNC screen display processing, C language executor processing (excluding high-level tasks), and macro executor processing (excluding execution macros). So, communication based on the embedded Ethernet function can decrease the performance of such processing.

- 4 Note that when the embedded Ethernet function is connected to an intranet that handles large volumes of broadcast data, for example, the processing of broadcast data can take a longer time, resulting in a decrease in performance of processing such as CNC screen display processing.

30.10 DATA INPUT/OUTPUT FUNCTION BASED ON THE I/O LINK AND DATA INPUT/OUTPUT FUNCTION B BASED ON THE I/O LINK

Power mate CNC programs, parameters, macro variables, and diagnostic (PMC) data are input/output using FANUC I/O Link.

With FANUC I/O Link, slaves in groups 0 to 15 can be connected, enabling data input/output to and from a maximum of 16 power mate CNCs.

The ordinary data input/output function based on I/O Link can only be executed in the foreground. When data input/output function B based on I/O Link is used, the external I/O device control function is associated with I/O Link so that an input/output group number and program number can be specified from the PMC. The external I/O device control function operates in the background. Therefore, when no other background operation is being performed, data can be input/output, regardless of the NC mode and the currently selected screen.

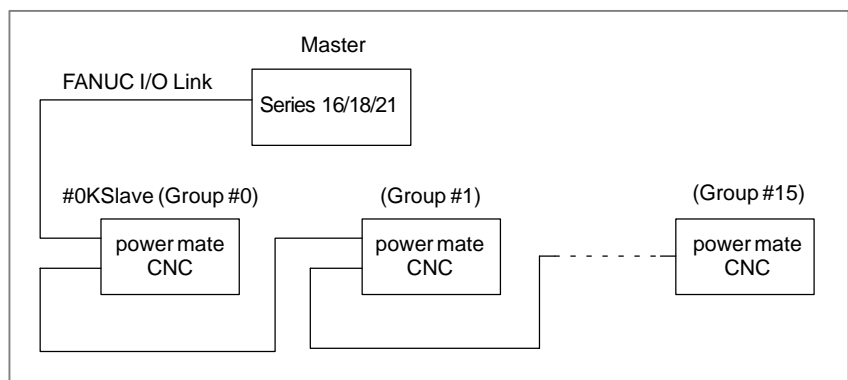

The programs, parameters, macro variables, and diagnostic (PMC) data of a slave power mate CNC are stored in tape format within the part program storage length; these data items are stored as master program data in a master program memory area.

Data input/output can be performed between the master and a slave of a selected group. When the ordinary data input/output function based on I/O Link is used, a group is selected by means of parameter setting. When data input/output function B based on I/O Link is used, a group is selected by issuing the DI signal. Data input/output cannot be performed between the master and more than one group at a time.

30.11 POWER MATE CNC MANAGER

When the power mate CNC series is used as an additional (slave) axis of the CNC, the power mate CNC manager enables the display and setting of data from the CNC. Up to eight slave units can be connected.

The power motion manager supports the following functions:

- 1) Current position display (absolute/machine coordinate)
- 2) Parameter display and setting
- 3) Diagnosis
- 4) System configuration screen
- 5) Alarm

POWER MOTION MANAGER/SYSTEM CONFIGURATION		O12345678 N12345									
1. GROUP0 /PM-E O12345678 N12345		2. GROUP2 /E									
SYSTEM	****-##	SYSTEM	****-##								
SERVO	****-##	SERVO	****-##								
PMC	****-##										
LADDER	****-##										
MACRO	****-##										
3. GROUP2 /E		4. GROUP4 /E									
SYSTEM	****-##	SYSTEM	****-##								
SERVO	****-##	SERVO	****-##								
<table border="1" style="width: 100%; border-collapse: collapse;"> <tr> <td style="width: 12.5%;">PARAM</td> <td style="width: 12.5%;">DGNOS</td> <td style="width: 12.5%; text-align: center;">SYSTEM</td> <td style="width: 12.5%;"></td> <td style="width: 12.5%;"></td> <td style="width: 12.5%;"></td> <td style="width: 12.5%;"></td> <td style="width: 12.5%;">USER HISTORY <OPRT></td> </tr> </table>				PARAM	DGNOS	SYSTEM					USER HISTORY <OPRT>
PARAM	DGNOS	SYSTEM					USER HISTORY <OPRT>				

The sample screen shows the data for four units, displayed on a 12 soft key type device. The same data can also be displayed on a 7 soft key type device.

30.12 FIELD NETWORKS

The field networks listed below are supported to transfer DI/DO signals assigned to PMC addresses to other CNCs or other vendors' devices that conform to the same communication standards.

I/O Link-II

I/O Link-II is a communication function conforming to OPCN-1 (JEMA net) defined by the Japan Electrical Manufacturers' Association. The I/O Link-II function includes master and slave functions. For details, refer to "I/O Link-II Connection Manual (B-62714EN)."

PROFIBUS-DP

PROFIBUS-DP is a communication function defined by the PROFIBUS Association. PROFIBUS-DP contains master and slave functions. The CNC can support both functions simultaneously. For details, refer to "FANUC Profibus-DP Board Operator's Manual (B-62714EN)."

DeviceNet

DeviceNet is a communication function defined by Open DeviceNet Vendor Association, Inc. (ODVA). DeviceNet contains master and slave functions. The CNC can support either the master or slave function. For details, refer to "FANUC DeviceNet Board Operator's Manual (B-63404EN)."

FL-Net

FL-net is a communication function conforming to OPCN-2 defined by the Japan Electrical Manufacturers' Association. FL-net can handle large DI/DO data at high speed in masterless communication. For details, refer to "FANUC FL-net Board Operator's Manual (B-63434EN)."

31

SAFETY FUNCTIONS



31.1 EMERGENCY STOP

With the emergency stop, all commands stop, and the machine stops immediately. Connect the “emergency stop” signal both to the control unit and to the servo unit side.

When emergency stop is commanded, servo excitation is also reset, and servo ready signal will also turn off. Move distance of the machine will still be reflected in the actual position and machine position will not be lost (Follow up function). After resetting the emergency stop, operation can thus be continued without need of another reference point return.

To design a safe machine tool, use an emergency stop signal for it properly.

The emergency stop signal is intended to bring a machine tool to an emergency stop. It is input to the CNC control unit, servo amplifier, and spindle amplifier. Generally, the B contact of a pushbutton switch is used to input the emergency stop signal.

Closing the contact used for the emergency stop signal (*ESP) releases the CNC unit from an emergency stop state, thus enabling it to control and operate the servo motor and spindle motor.

Opening the contact used for the emergency stop signal (*ESP) resets the CNC unit and brings it to an emergency stop. Opening the contact also decelerates the servo motor and spindle motor to a stop.

Switching off the electric power of the servo amplifier for a servo motor applies a dynamic brake to the servo motor. If the servo motor is used for a horizontal axis, however, a load on the horizontal axis may drop to cause the servo motor to rotate. To avoid this unintended motion, use a servo motor with a brake or use another appropriate provision.

Switching off the electric power of the servo amplifier for a spindle motor suddenly allows the spindle motor to keep rotating from force of habit, which can be dangerous.

Avoiding this danger requires a control function that detects when the emergency stop signal (*ESP) contact becomes open, and makes sure that the spindle motor decelerates to a stop, then switches off the electric power.

The FANUC control amplifier series is designed with considerations on the behavior mentioned above. Just supply an emergency stop signal to the power supply module (hereafter called PSM) of the control amplifier series. The PSM outputs an electric power MCC control signal. This signal can be used to switch on and off the electric power supplied to the power supply module.

Basically, this CNC control unit is designed to use a software limit function to detect overtravel, so an ordinary overtravel detection limit switch is unnecessary. However, a stroke end limit switch must be provided and connected to an emergency stop signal so that the emergency stop signal can cause the machine to stop if the machine goes over the software limit because of a servo feedback system failure.

The following diagram shows an example of connecting an emergency stop signal when the CNC control unit and series control amplifier are used.

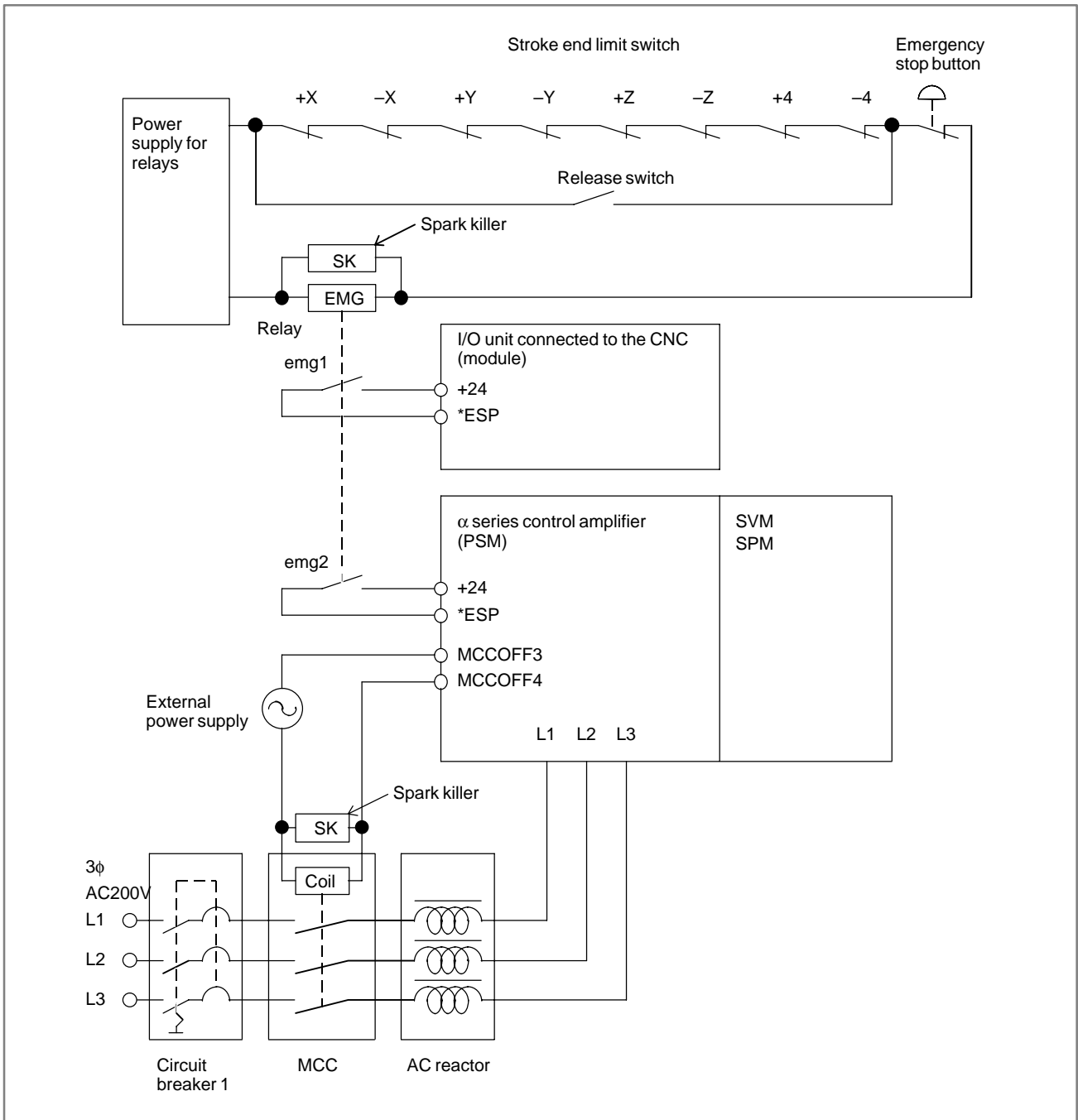

CAUTION

When connecting the CNC unit to a spindle motor and amplifier from a manufacturer other than FANUC, you should develop a sequence that, if the emergency stop signal contact becomes open when the spindle motor is running, decelerates the spindle motor to a stop safely, according to the respective manuals.

31.2 OVERTRAVEL FUNCTIONS

31.2.1 Overtravel

When the movable section has gone beyond the stroke end, a signal is output, the axis decelerates to a stop, and overtravel alarm is displayed. All directions on all axes has overtravel signals.

31.2.2 Stored Stroke Check 1

The movable section of the machine is parameter set in machine coordinates value. If the machine moves beyond the preset range, it decelerates to a stop and alarm is displayed. (This function is valid after manual reference point return at power on.)

This function can be used instead of hardware overtravel limit switch. When both is equipped with, both are valid.

Unlike overtravel detection, stored stroke check 1 checks whether the distance between the current position and that at which the tool will be stopped after deceleration exceeds the limit.

- For manual operation, parameter setting can be made to stop tool movement along an axis when the tool is on a boundary with the inhibition area and generate an alarm.
- For manual operation, parameter setting can be made to output just a stroke limit arrival signal without generating any alarm when the tool enters the inhibition area. (Movement along an axis is stopped.)

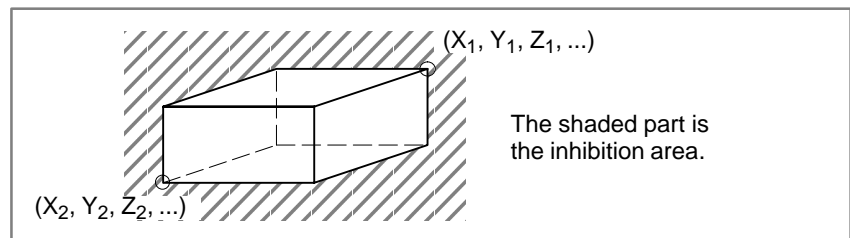

- **Automatic alarm release**

After an OT alarm is generated, moving the tool along the axis to the movable range can release the OT alarm without reset operation. Whether to enable automatic release is specified by parameter setting.

31.2.3 **M series** Stored Stroke Check 2 (G22, G23)

An inhibition area can be specified inside or outside an area set by parameter or by program. Command distance from the machine coordinates zero point for limit positions. This function is valid after manual reference point return right after the power on. When specifying the limits with program, limits or axes X, Y, Z can be set. The inhibition area can be changed according to the workpiece. The parameter decides whether the inhibition area is outside or inside the specified area.

- Parameter setting can be made to generate an alarm before the inhibition area is entered.

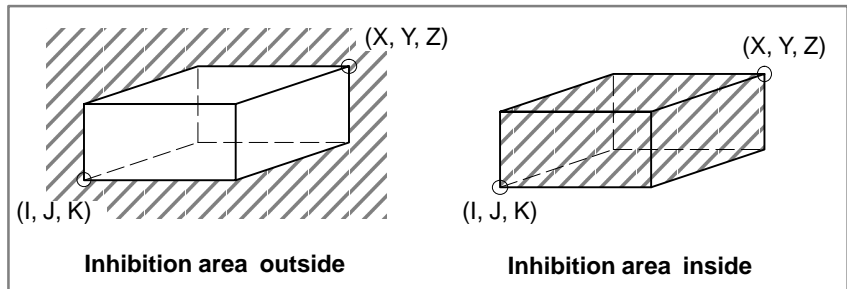

Format

G22 X_Y_Z_I_J_K ;

On/off of stored stroke check 2 is commanded by program as follows:

G22 : Stored stroke check function on

G23 : Stored stroke check function off

31.2.4 **M series** Stored Stroke Checks 3

The space within the range specified with parameters is inhibited.

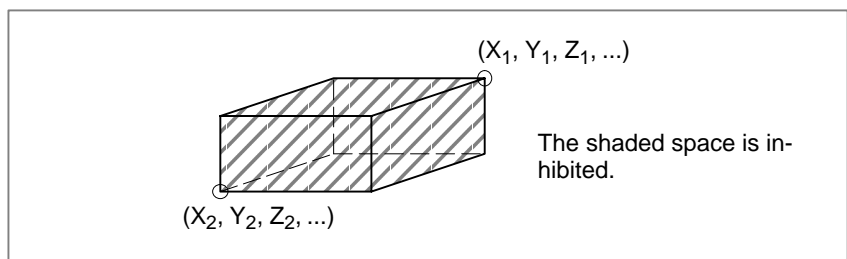

31.2.5 **T series** Stored Stroke Checks 2 and 3 (G22, G23)

The designation of the forbidden area can be specified by parameters or program.

The forbidden area can be changed for each workpiece. Selection between inside or outside as the forbidden area is made by parameters.

Stored stroke check 2 (G22, G23)

The designation of the forbidden area can be specified by parameters or program.

The forbidden area can be changed for each workpiece. Selection between inside or outside as the forbidden area is made by parameters.

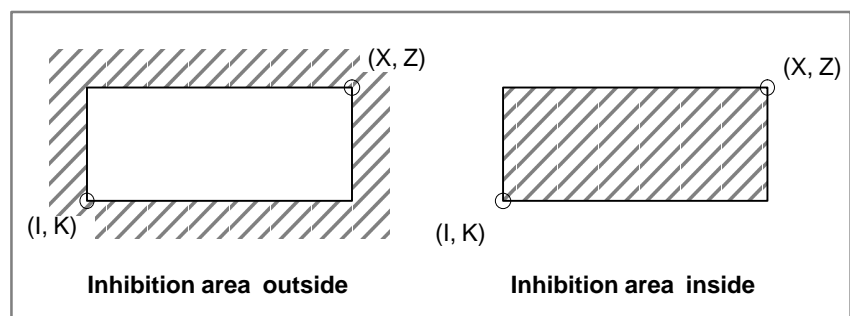

Stored stroke check 3

Inside the area specified by parameters is the forbidden area.

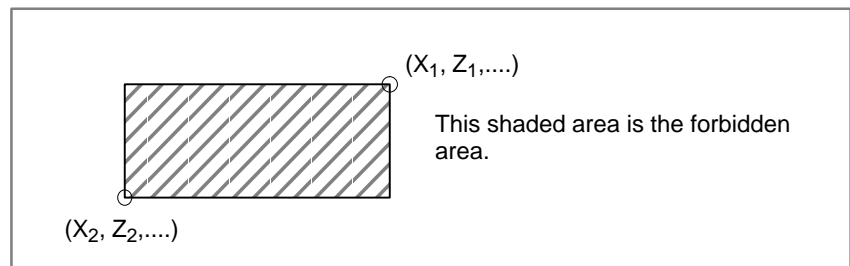

Format

G22 X_ Z_ I_ K_ ;

On/off of stored stroke check 2 is commanded by program as follows:

G22 : Stored stroke check function on

G23 : Stored stroke check function off

31.2.6 Stroke Limit Check Before Movement

This function calculates the movement end point at the start of movement in a block, during automatic operation, based on the current machine position and the specified amount of travel, to check whether the end point falls within the inhibited area for stored stroke limit 1, 2, or 3. If the end point falls within an inhibited area, movement for that block is stopped immediately upon the start of movement and an alarm is issued.

NOTE

This function checks only whether the end point falls within an inhibited area. It does not check whether the tool passes through an inhibited area between the start and end points. However, an alarm is issued upon a tool's entering an inhibited area according to stored stroke limit 1, 2, or 3.

Example 1)

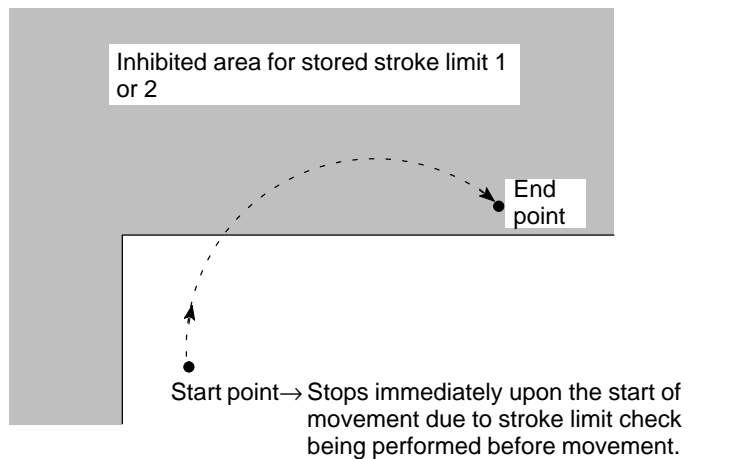
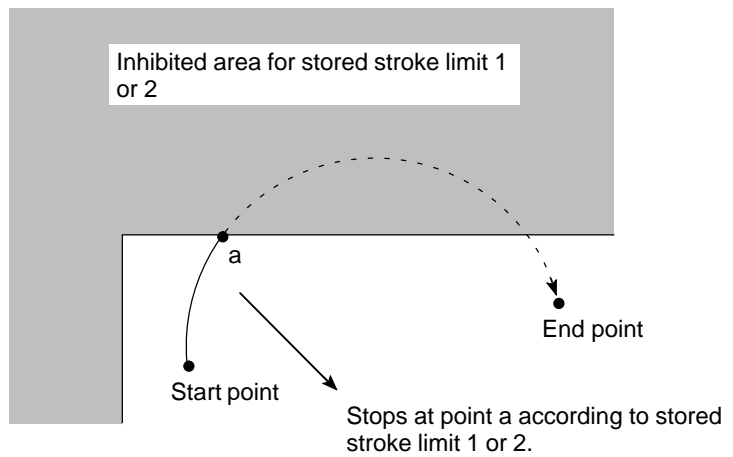

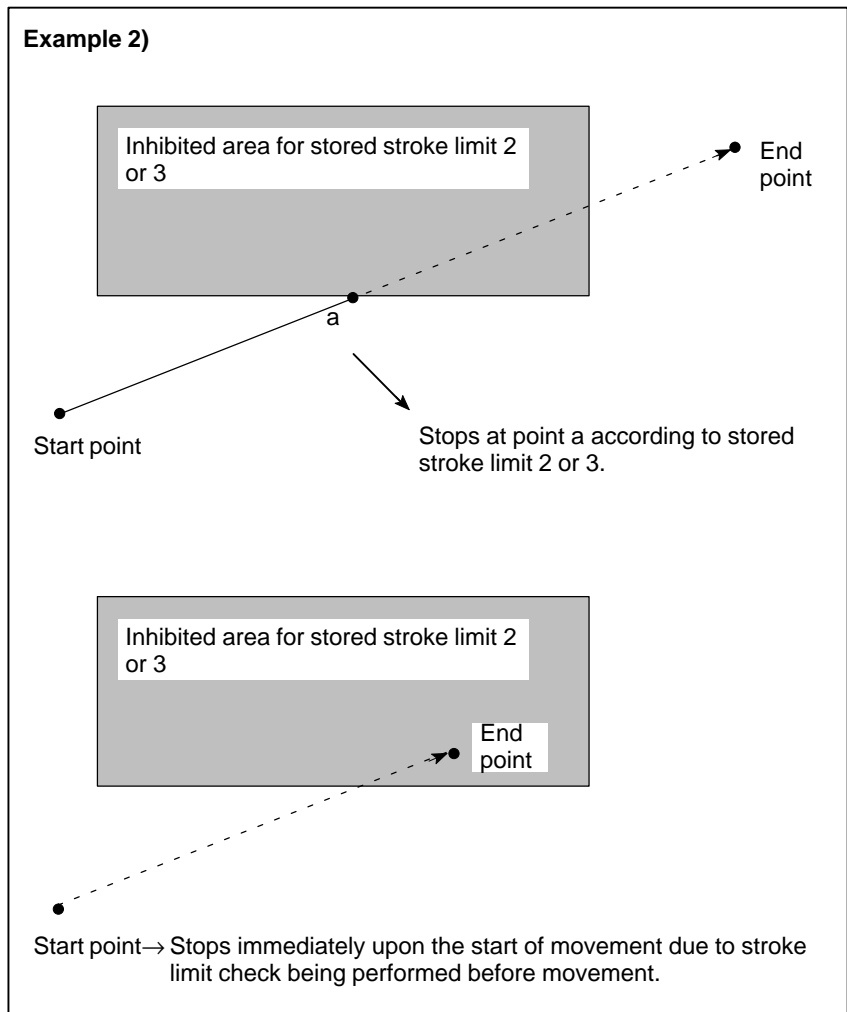

31.2.7 Externally Setting the Stroke Limit

When a new tool is mounted, position the tip of the tool on the two corners of the limit area, and specify the machine coordinates of the corners in the parameters for stroke limit 1. The machine coordinates are stored in the CNC as the limit positions. Then input signals for setting the stroke limit. Stroke limit setting signals are provided for each axis and each direction. Checking of the stroke limit can also be selected by turning on or off the limit release signal common to all axes.

31.2.8 Chuck/Tail Stock Barrier

T series

It is used for checking the interference between the chuck and tail stocks and preventing the damage of machines.

Set the area of entry prohibition from the exclusive setting screen according to the shapes of chuck and tail stocks.

When a tool enters the area of entry prohibition during cutting, the travelling of tool is stopped and an alarm message is displayed. The tool can be escaped from the prohibition area by moving in the opposite direction to that on entry. The Yes/No of this function is selected by the G22 (Stored stroke limit on), G23 (Stored stroke limit off), and signal of machine side.

G code	Tail stock barrier select signal	Chuck barrier	Tail stock barrier
G22	0	Yes	Yes
G22	1	Yes	No
G23	Irrelevant	No	No

The shape of chuck or tail stock is defined on the setting screen.

Explanations

- Dimension definition of chuck

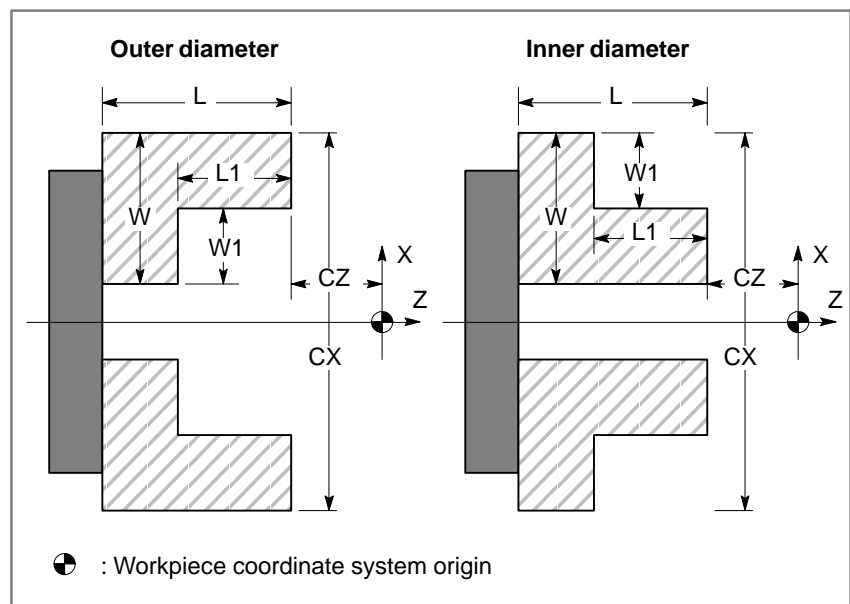

Symbol	Description
L	Length of chucking claw
W	Size of chucking (radius input)
L1	Holding length of chucking claw
W1	Holding difference of chucking claw (radius input)
CX	Position of chuck (X axis)
CZ	Position of chuck (Z axis)

● **Dimension definition of tail stock**

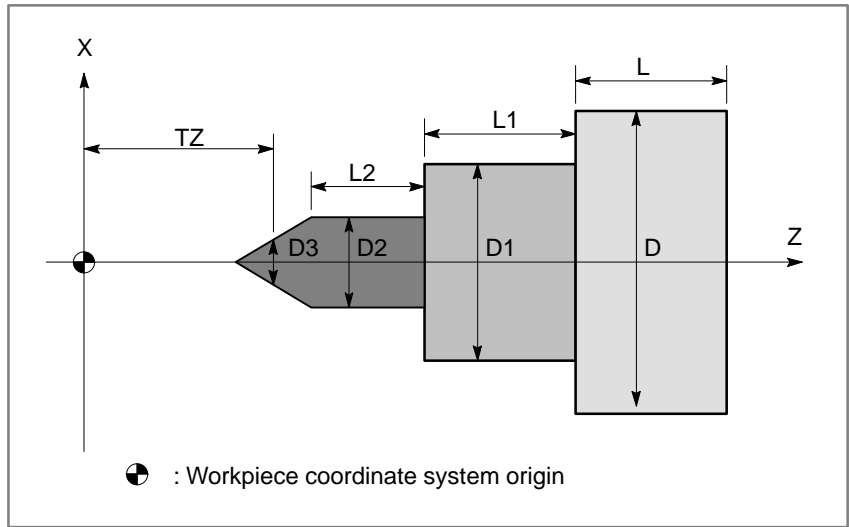

Symbol	Description
L	Length of tail stock
D	Diameter of tail stock (Diameter input)
L1	Length of tail stock (1)
D1	Diameter of tail stock (1) (Diameter input)
L2	Length of tail stock (2)
D2	Diameter of tail stock (2) (Diameter input)
D3	Hole diameter of tail stock (Diameter input)
TZ	Position of tail stock (Z axis)

NOTE

This function cannot be used together with stored stroke check 2 or 3.

31.2.9 Rotation Area Interference Check

This function checks for interference among the tool post and chucks and stops the machine safely. Three major interference check areas can be set, each of which is specified by using rectangles. Two of the three interference check areas can be moved and rotated.

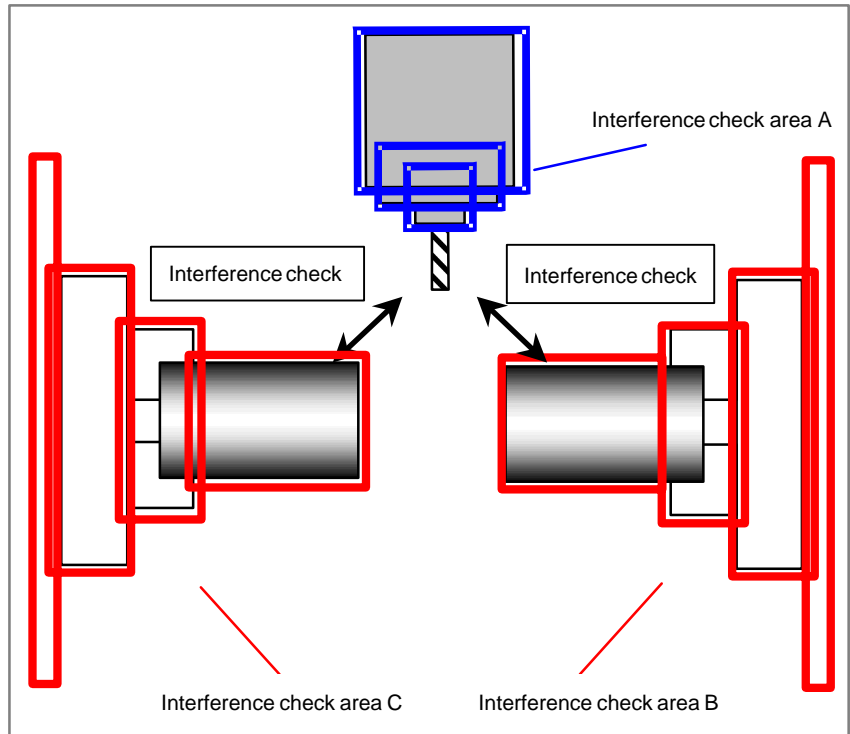

You can set the following interference check areas:

- 1) Interference check area A and interference check area B
You can set four rectangles. The entire area moves according to the movement along parameter-set two axes. In addition, the entire area can be rotated according to the rotation on a parameter-set axis.
- 2) Interference check area C
You can set four rectangles. The area cannot be moved and rotated.

31.3 INTERLOCK

31.3.1 Interlock per Axis

Axis feed specified to each axis can be stopped separately. If interlock is specified to any of the moving axis during cutting feed, all axes of the machine movement will decelerate to a stop. When interlock signal is reset, the moving starts.

31.3.2 All Axes Interlock

Feed of all axes can be inhibited. When all axes interlock is commanded during move, it decelerates and stops. When all axes interlock signal is reset, the moving restarts.

31.3.3 Interlock for Each Axis Direction

Feeding of a specific axis in a specific direction can be inhibited independently of other axes. If the interlock signal is input to any of the axes during a cutting feed operation, all axes decelerate and come to a stop. When the interlock signal for each axis direction is released, the axes start moving again.

This function is usable for both the manual and automatic operations of the M series. For the T series, the DAU parameter (bit 4 of parameter No. 3003) can be used to specify whether to make the function usable only for the manual operation or for both the manual and automatic operations.

NOTE

To enable axis direction-specific interlocking for the automatic operation of the T series, set the DAU parameter (bit 4 of parameter No. 3003).

31.3.4 Start Lock

T series

Feeding of all axes can be inhibited only during automatic operation. When the start lock signal is input while the axes are moving, all axes decelerate and come to a stop. When the start lock signal is released, the axes start moving again.

31.3.5 Block Start Interlock

During automatic operation, the start of the next block can be disabled. A block that has already started is executed as is till its end. When the block start interlock is released, the execution of the next block starts.

31.3.6 Cutting Block Start Interlock

During automatic operation, the start of a block containing a move command other than positioning can be disabled.

When the cutting block start interlock is released, the execution of the next block starts.

When spindle rotation is specified or when the spindle speed is changed, the cutting block start interlock can be applied until the spindle reaches a target speed so that the next cutting block can be executed at the target spindle speed.

31.4 EXTERNAL DECELERATION

Feed rate can be decelerated by an external deceleration signal from the machine side. A feed rate after deceleration can be set by parameter. External deceleration is prepared every axis and every direction.

When the tool is to be moved in the reverse direction, futile time may not be wasted since no external deceleration is applied.

By setting the corresponding parameter, whether to make this signal effective only for rapid traverse mode or for all feed modes can be specified for each axis and for each direction.

This function allows the maximum of valid strokes and keeps shock to the machine to a minimum, to stops at stroke end.

31.5 ABNORMAL LOAD DETECTION

When a cutting tool collides with the machine body or is damaged during cutting, the load torque applied to the motors is larger than during normal feeding or cutting. The abnormal load detection function calculates the load torque and transfers the value from the CNC to the PMC. If the load torque is larger than the value set in a parameter, the function stop the motor or reverses the motor rotation to retract the tool by the distance set in a parameter. In this way, damage to the machine is prevented. (The motor rotation reverse function is available only for the servo motor axes.) Abnormal load detection can be disabled only for a specific axis.

31.6 FINE TORQUE SENSING

The CNC stores disturbance load torque data detected by servo control software or spindle control software in internal memory.

- 1 Referencing stored torque data with the PMC via a window
- 2 Calculating the average, maximum and distribution of stored torque data (statistical calculation) and reading these values through a window
- 3 Plotting a graph of stored torque data on the torque monitor screen
- 4 Setting the detection level of the abnormal load detection alarm on the torque monitor screen. (The abnormal load detection function is a separate option.)
- 5 Saving stored torque data as sample data so that it can be compared with later data
- 6 Saving stored torque data in a memory card

CAUTION

This function is a monitor function providing detailed disturbance load torque data. This function allows monitoring of more detailed information about the disturbance load for each axis. When this monitor function is used to develop and supply a protection function for a machine or tool, a thorough confirmation must be made using the actual machine to ensure that an appropriate operation can be obtained before the function is supplied.

31.7 SERVO/SPINDLE MOTOR SPEED DETECTION

The servo axis and spindle motor speeds are monitored. If the speed of an axis exceeds a preset maximum (specified by parameter setting), the corresponding signal is output to a Y address (specified by parameter setting) of the PMC.

The following diagram illustrates the signal output state.

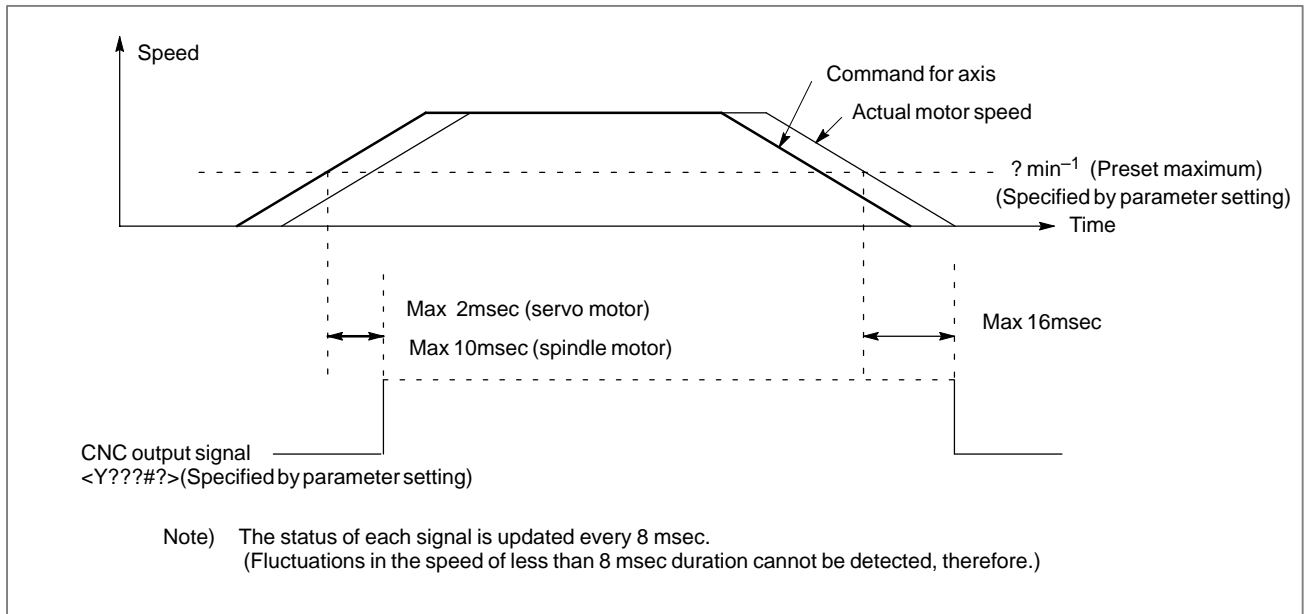

32 STATUS OUTPUT



**32.1
NC READY SIGNAL**

This signal is sent to the PMC when NC power is on and control becomes possible. Sending of this signal will be stopped when NC power is turned off.

**32.2
SERVO READY
SIGNAL**

This signal is sent to the PMC when the servo system becomes operatable. Axes necessary to be braked must be braked when this signal is not sent.

**32.3
REWINDING SIGNAL**

This signal shows that tape reader or main program in memory is rewinding.

**32.4
ALARM SIGNAL**

This signal is transmitted when the NC comes under an alarm status.

**32.5
DISTRIBUTION END
SIGNAL**

This signal is sent out when pulse distribution of the M, S, T, or B functions has ended, so that they can be used after move of the commanded block ends.

**32.6
AUTOMATIC
OPERATION SIGNAL**

This signal is sent out when it is under automatic operation.

**32.7
AUTOMATIC
OPERATION START
SIGNAL**

This signal is sent out when automatic operation is being activated.

**32.8
FEED HOLD SIGNAL**

This signal is sent out when automatic operation is held by feed hold.

**32.9
RESET SIGNAL**

This signal is sent out to show that the NC has been reset.

**32.10
IN-POSITION SIGNAL**

This signal shows that an axis is under in-position status. This signal is output for all axes.

**32.11
MOVE SIGNAL**

This signal shows that an axis is moving. This signal is sent out for every axis.

This move signal can be combined with the interlock signal to automatically clamp and unclamp the machine, or control on/off of the lubricating oil.

32.12 AXIS MOVE DIRECTION SIGNAL

This signal is output to show move direction of each axis. This signal is output for each axis.

32.13 RAPID TRAVERSING SIGNAL

This signal shows that the move command is done under rapid traverse.

32.14 TAPPING SIGNAL

This signal is output to show that the machine is under tapping mode (G63 for M series) or tapping cycle (G74, G84 for M series), (G84, G88 for T series) is under operation.

32.15 THREAD CUTTING SIGNAL

This signal shows that the machine is under thread cutting mode (G33) or thread cutting cycle (T series).

32.16 CONSTANT SURFACE SPEED CONTROL SIGNAL

This signal shows that the machine is under constant surface speed control mode (G96).

32.17 INCH INPUT SIGNAL

This signal shows that input is done under inch input mode (G20).

32.18 DI STATUS OUTPUT SIGNAL

To inform the exterior of the states of software operator's panel, which are set via CRT/MDI, and machine operator's panel, following DI state output signals are sent.

- Mode-select check signal
- Single-block check signal
- Manual absolute on/off check signal
- Dry-run check signal
- Machine-lock check signal
- Auxiliary-function-lock check signal
- Optional block-skip check signal
- Mirror-image check signal

32.19 POSITION SWITCH FUNCTION

The position switch function outputs a signal to a specified controlled-axis when the machine coordinates of the controlled-axis are within the range specified by the corresponding parameter.

The parameter specifies an arbitrary controlled-axis and the operating range (machine coordinates) within which the position switch signal is output.

Up to sixteen position switch signals can be output.

32.20 HIGH-SPEED POSITION SWITCH

The high-speed position switch function obtains the current position of an arbitrary controlled axis from the machine coordinates and the feedback data from the position detector and outputs a signal if the current position is within a certain range. This function uses a shorter monitoring period than that of the ordinary position switch, enabling faster and more accurate monitoring.

Up to 16 high-speed position switch signals can be output.

32.21 DIRECTION DECISION TYPE HIGH-SPEED POSITION SWITCH

This function monitors the machine coordinates and operation direction for an arbitrary controlled axis and turns the high-speed position switch signal output on and off. There are two positions of which machine coordinates are to be monitored. When the tool passes the coordinates of one of the two positions in a specified direction, the signal goes on; when the tool passes the coordinates of the other position in a specified direction, the signal goes off. These coordinates and directions are set with parameters.

33

EXTERNAL DATA INPUT



The external data input is as follows.

- External tool compensation
- External program number search
- External work coordinate system shift
- External machine zero point shift
- External alarm message
- External operator message
- Substitution of the number of machined parts and number of required parts

33.1 EXTERNAL TOOL COMPENSATION

The tool compensation value for the offset number specified in the program can be externally modified.

The input signal designates whether the input tool offset amount is:

- absolute or incremental
- geometry offset or tool wear offset
- cutter radius compensation amount or tool length compensation amount

If the machine is equipped with automatic measurement devices of tools and workpiece, error can be input to the NC with this function.

External tool compensation amount range is:

0 to ± 7999

in least command increment.

33.2 EXTERNAL PROGRAM NUMBER SEARCH

A program number from 1 - 9999 can be given from outside to the NC to call the corresponding program from the NC memory.

In machines with automatic loading function of various workpiece, this function can be used to automatically select and execute program suitable to the workpiece.

With bit 3 (ESC) of parameter No. 6300, the external program number search function can also be cancelled by a CNC reset operation.

33.3 ONE-TOUCH MACRO CALL

Just by pressing a switch mounted on the machine, the following three operations can be performed only with minimum ladder changes:

- (1) Change to MEM mode
- (2) Execution of a macro program stored in memory
- (3) Restoration to the mode present before execution. Automatic selection of a program selected before execution

This function is enabled only in the reset state. This means that this function is not available during automatic operation (including the automatic operation halt state and automatic operation stop state).

33.4 EXTERNAL WORKPIECE COORDINATE SYSTEM SHIFT

The work coordinate system can be shifted for the shift amount given from outside.

The shift amount specified by an input signal is set as an external offset value for workpiece zero points by which the workpiece coordinate system shifts. The shift amount is an absolute value, not an incremental value.

The shift amount range is :

0 to ± 7999

in least command increment.

33.5 EXTERNAL MACHINE ZERO POINT SHIFT

The machine coordinate system is compensated by shift amount given from outside. This shift amount always take absolute value; never an increment value.

The shift amount range is:

0 to ± 9999

in detection unit.

When shift amount is input, the actual machine move distance is the difference between the previous offset amount and current offset amount. This function is used to compensate the machine coordinate system error caused by mechanical deformation.

33.6 EXTERNAL ALARM MESSAGE

By sending alarm number from outside, the NC is brought to an alarm status; an alarm message is sent to the NC, and the message is displayed on the screen of the NC. Reset of alarm status is also done with external data.

Up to 4 alarm numbers and messages can be sent at a single time. Alarms 0 to 999 can be sent. To distinguish these alarms from other alarms, the CNC displays them by adding 1000 to each alarm number. The messages of up to 32 characters can be sent together with an alarm.

33.7 EXTERNAL OPERATOR'S MESSAGE

Message to the operator is given from outside the NC, and the message is displayed.

The message is sent after a message number 0 to 999. Either a message consisting of up to 255 characters or up to four messages each consisting of up to 63 characters can be displayed at the same time by parameter setting.

The message numbers 0 to 99 are displayed along with the message.

To distinguish these alarms from other alarms, the CNC displays them by adding 2000 to each alarm number. When a message from 100 to 999 is displayed, the message number is not displayed; only its text is displayed. An external data will clear the operator messages.

33.8 SUBSTITUTION OF THE NUMBER OF REQUIRED PARTS AND NUMBER OF MACHINED PARTS

The number of required parts and the number of machined parts can be preset externally. Values from 0 to 9999 can be preset.

34

KEY INPUT FROM PMC (EXTERNAL KEY INPUT)

When the PMC inputs the code signal corresponding to a key on the MDI panel to the CNC, the code signal can be input in the same way as with actual operation of the key on the MDI panel. For example, this function is usable in the following case:

After allowing to travel the tool at an arbitrary machining position by using the playback function (option), when to store its positions as the program command, X, Y, Z, <INSERT>, etc. must be input via key operations. However, these operations can be realized simply by depressing a switch on the operator's panel at the machine side.

When the switch is pressed, the PMC inputs code signals corresponding to keys X, Y, Z, and <INSERT> to the CNC. This produces the same results as with actual key operations.

35

PERSONAL COMPUTER FUNCTION



The machine tool builder can connect a CNC and personal computer to incorporate a high-level man-machine interface, such as conversational automatic programming or conversational operation, that makes the most use of machine tool builder's know-how.

The following types of OPEN CNCs are available:

- 160*i*/180*i*/210*i*
PANEL *i* that is connected via the high-speed serial bus
- 160*is*/180*is*/210*is* (using the built-in personal computer function)
Windows®CE personal computer function that is built into the CNC printed circuit board, combined with a 10.4" color LCD
- 160*is*/180*is*/210*is* (using the stand-alone personal computer function)
CNC display unit for the *is* series CNC connected via the high-speed serial bus

A commercially available IBM PC-compatible personal computer can also be connected via the high-speed serial bus.

35.1
160i/180i/210i

To the 160i/180i/210i, a PANEL *i* is connected via the high-speed serial bus described later.

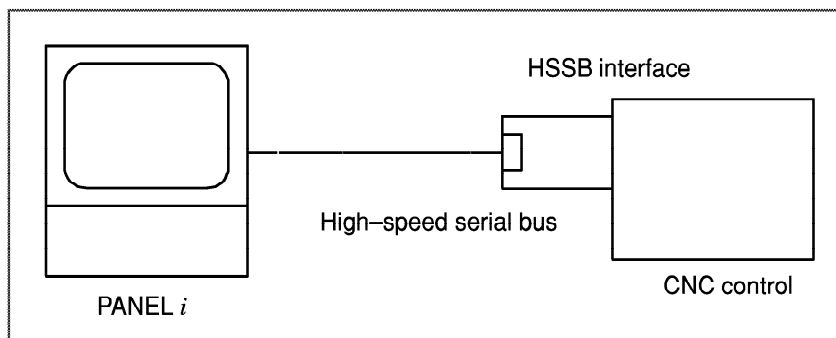

Hardware specifications of the PANEL *i* that is used for the 160i/180i/210i

Item	Specification	Remarks
CPU	Pentium® III Celeron™ *1	
Main memory	512M bytes max	
Hard disk	40G bytes	
Display	10.4" color TFT LCD (640 × 480 dots) 12.1" color TFT LCD (800 × 600 dots) 15.0" color TFT LCD (1024 × 768 dots)	Up to 260,000 colors can be displayed with the 10.4" or 12.1" type. Up to 16,000,000 col- ors can be displayed with the 15.0" type. *2, *6
	Touch panel	Optional
Ports	PCMCIA 1 slot Full keyboard × 1 Mouse × 1 Serial (RS-232C) × 2 Floppy disk drive × 1 Parallel × 1 USB × 2 Ethernet × 1	The touch panel is connected to serial port 1 connector.
Interface with CNC	High-speed serial bus (optical fiber cable)	Maximum length: 100 m
Expansion slot	PCI specification expansion slot (Short card size) × 2	*3
Ambient tempera- ture of the unit	Operating: 5°C to 45°C Non-operating: -20°C to 60°C	
Ambient relative humidity	Normal: 10% to 76% (no condensation) Short period (within one month): 10% to 90% (no con- densation)	

Personal computer software for 160i/180i/210i

Item	Specification	Remarks
Operating system	Windows® 2000 Windows® XP *1, *5	
Expansion library	FOCAS2 *1	
Package software	Basic operation package	Option
	Milling animation function	Option
	CNC screen display function	Option
	Ladder editing package	Option
	DNC operation management package	Option
	Machining status monitor package	Option
Development tools	Visual C++® Visual Basic® *1	Microsoft Corp. Microsoft Corp.

NOTE

*1 Intel, Pentium are registered trademarks of Intel Corporation. Celeron is trademark of Intel Corporation, Microsoft, Windows, Windows NT, Visual C++, Visual Basic are registered trademarks of Microsoft Corporation. Each company's name and product's name is the trademark or registered trademark.

*2 A special driver is necessary to display 16 or more colors.

*3 Extension Board for IBM PC should be prepared by MTB.

*4 FOCAS2: FANUC Open CNC API Specifications version 2

*5 Some of the hardware/software products are not available in Windows® 2000 at present.

*6 An LCD is created using high-precision processing technology. On the LCD, some points may be always on; others may be always off. This status is caused due to the structure of the LCD and indicates no failure.

35.2
160is/180is/210is

160is/180is/210is are Open CNC with high reliability that uses Windows® CE and no hard disk.

Personal computer software for 160is/180is/210is

Item	Specification	Remarks
Operating system	Windows® CE	
Expansion library	FOCAS1 *1	
Package software	CNC screen display function	
Development tools	eMbedded™ Visual Tools 3.0 *2	Microsoft Corp.

160is/180is/210is (using the built-in personal computer function)

The 160is/180is/210is (using the built-in personal computer function) has the following features in addition to the features common to the 160is/180is/210is:

- Installation combined with the CNC
- Direct connection to the CNC via a bus, enabling the high-speed exchange of a wide range of information

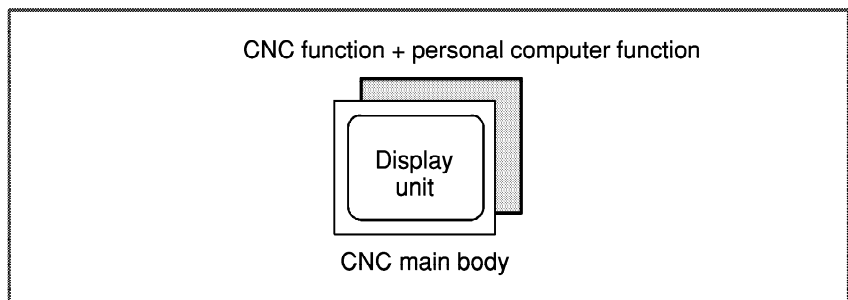

Hardware of the personal computer section on the 160is/180is/210is (using the built-in personal computer function)
(Personal computer function using Windows® CE integrated with the CNC functions on the rear of the LCD)

Item	Specification	Remarks
CPU	Renesas SH-4	
Main memory	64M bytes	
File memory	Compact flash™ card *3	Built-in
Display	10.4" color TFT LCD (with a touch panel) 640 × 480 dots 12.1" color TFT LCD (with a touch panel) 800 × 600 dots	*4
	Touch panel	Optional
Ports	PCMCIA × 1 slot Ethernet (100BASE-TX) USB × 1	

**Hardware of the personal computer section on the 160is/180is/210is
(using the built-in personal computer function)
(Personal computer function using Windows® CE integrated with the
CNC functions on the rear of the LCD)**

Item	Specification	Remarks
Ambient temperature of the unit	Operating: 0°C to 58°C Non-operating: -20°C to 60°C	
Ambient relative humidity	Normal: 10% to 75% (no condensation) Short period (within one month): 10% to 90% (no condensation)	

NOTE

- *1 FOCAS1: FANUC Open CNC API Specifications version 1
- *2 eMbedded Visual Tools is a registered trademark of Microsoft Corporation.
- *3 Compact flash is a registered trademark of SanDisk.
Each company name and product are a registered trademark or a trademark of each company.
- *4 An LCD is created using high-precision processing technology. On the LCD, some points may be always on; others may be always off. This status is caused due to the structure of the LCD and indicates no failure.

160is/180is/210is (using the stand-alone personal computer function)

The 160is/180is/210is (using the stand-alone personal computer function) uses the is series CNC display unit via the high-speed serial bus described later.

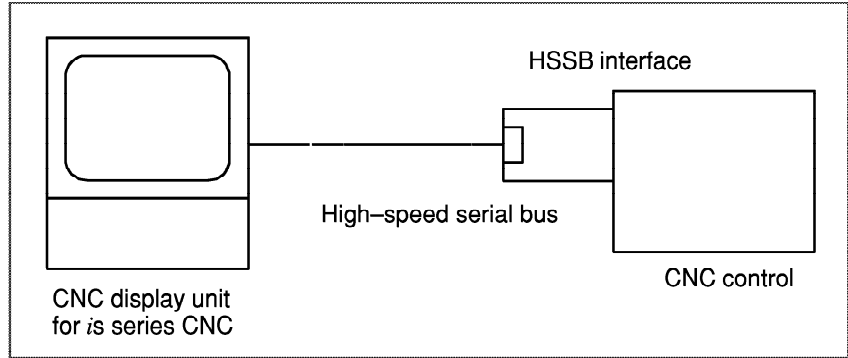

Hardware specifications of the is series CNC display unit used for the 160is/180is/210is

Item	Specification	Remarks
CPU	Renesas SH-4	
Main memory	64M bytes	
File memory	Compact flash™ card *6	Built-in
Display	10.4" color TFT LCD (with a touch panel) 640 × 480 dots 12.1" color TFT LCD (with a touch panel) 800 × 600 dots	*2
	Touch panel	Optional
Ports	PCMCIA × 1 slot Ethernet (100BASE-TX) USB × 1	
Ambient temperature of the unit	Operating: 0°C to 58°C Non-operating: -20°C to 60°C	
Ambient relative humidity	Normal: 10% to 75% (no condensation) Short period (within one month): 10% to 90% (no condensation)	

NOTE

*1 Compact Flash is registered trademark of SanDisk Corporation. Each company name and product are a registered trademark or a trademark of each company.

*2 An LCD is created using high-precision processing technology. On the LCD, some points may be always on; others may be always off. This status is caused due to the structure of the LCD and indicates no failure.

35.3 HIGH-SPEED SERIAL BUS (HSSB)

High-speed serial bus (HSSB = High-Speed Serial Bus) is a serial interface used to perform high-speed data transfer between the CNC control unit and the PANEL *i* or display unit for *is* series CNC on the operator's panel side or a commercially available personal computer.

The PANEL *i* or display unit for *is* series CNC or an IBM PC compatible personal computer can be connected to the CNC control unit via the high-speed serial bus. The FANUC PANEL *i* can be attached directly to the high-speed serial bus, and the personal computer can be attached to the bus if a dedicated interface board is installed in the personal computer.

The high-speed serial bus has the following features:

- Large amounts of data can be transferred between the personal computer and CNC control unit at high speed.
- A highly reliable optical fiber cable is used for connection.
- The machine tool builder can select an appropriate personal computer according to the specifications of the machine system.

35.4 SYSTEM IN WHICH A COMMERCIALY AVAILABLE PERSONAL COMPUTER AND THE CNC ARE CONNECTED VIA THE HIGH-SPEED SERIAL BUS

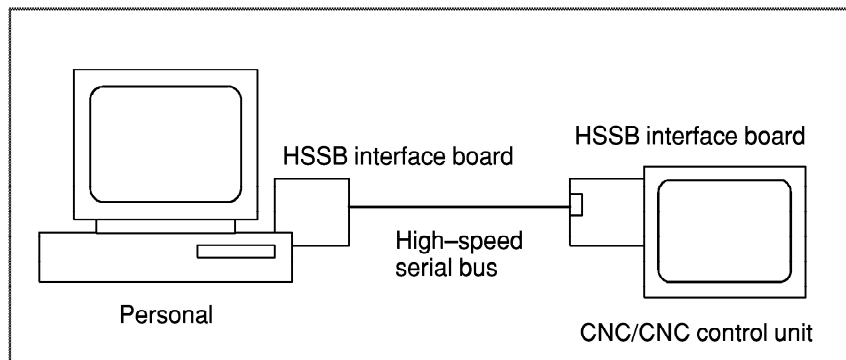

Hardware specifications of the high-speed serial bus

Item	Specification	Remarks
Interface board in CNC	For LCD-mounted type option slot For stand-alone type option slot	
Interface board in personal computer	For ISA bus, HSSB 1 channel For ISA bus, HSSB 2 channel	ISA compliant Power supply used: +5 V only
	For PCI bus, HSSB 1 channel For PCI bus, HSSB 2 channel	PCI compliant Power supply used: +5 V only
Connection cable	Optical fiber cable	Maximum length: 100 m
Personal computer requirements	CPU: Pentium® or higher At least one ISA or PCI slot (depending on the interface board used in the selected personal computer) *1	For the installation requirements of the personal computer, refer to the manual on the personal computer.

Software of the personal computer section

Item	Specification	Remarks
Operating system	Windows NT® 4.0 Windows® 2000 Windows® XP *1	
Expansion library	FOCAS2 *2	
Package software	Basic operation package Milling animation function CNC screen display function Ladder editing package DNC operation management package Operation status management package	Optional
Development tool	Visual C++® Visual Basic® *1	Microsoft Corporation

NOTE

- *1 Intel, Pentium are registered trademarks of Intel Corporation.
Microsoft, Windows, Windows NT, Visual C++, Visual Basic are registered trademarks of Microsoft Corporation.
Each company's name and product's name is the trademark or registered trademark.
- *2 FOCAS2: FANUC Open CNC API Specifications version 2

36

INTERFACE WITH THE POWER MATE CNC



36.1
FANUC SERVO
MOTOR β SERIES I/O
LINK OPTION
MANUAL HANDLE
INTERFACE
(PERIPHERAL
EQUIPMENT
CONTROL)

This function allows the use of a manual pulse generator on the host side to perform manual handle feed for the (β servo unit. The host posts pulses from the manual pulse generator to the (β servo unit via the I/O Link. A magnification can also be applied to the pulse output signal of the manual pulse generator by parameter setting. This function can be used only with the peripheral equipment control interface.

III. AUTOMATIC PROGRAMMING FUNCTION

1

OUTLINE OF CONVERSATIONAL AUTOMATIC PROGRAMMING



FANUC provides conversational automatic programming functions for lathes and machining centers.

With these conversational automatic programming functions, the user can enter data and create machining programs easily by following the displayed illustrations and instructions.

In addition, program checking and modifications can be performed easily.

2

CONVERSATIONAL AUTOMATIC PROGRAMMING FUNCTION FOR LATHES

There are three conversational automatic programming functions for lathes: Symbol CAPi T and Super CAPi T, and Manual Guide for lathe. The difference between the two functions is in the program input method. Symbol CAPi T uses the symbolic FAPT method for inputting programs. In Super CAPi T and Manual Guide for lathe programs are entered by selecting machining types.

For the 160i/180i/210i, use the CNC screen display function.

For the 160is/180is/210is, this function is unavailable.

2.1 Symbol CAPi T

2.1.1 Features

Symbol CAPi T is a conversational automatic programming function for lathes. It has the following features:

- Part figures can be input in a batch by using the symbolic keys.
- Even complicated part figures can be input by using the automatic intersection calculation function.
- The automatic process determination function creates necessary processes automatically.
- Any cutting direction or area can be specified.
- NC data can be created without superfluous movement, such as cutting through air.
- By using MTF, NC data suitable for the particular machine being used can be created.
- Coloring of screens can be set, and soft keys can be displayed to have a “raised” look.

2.1.2 Applicable Machines

Symbol CAPi T can be used with the following lathes:

- 1-spindle/1-turret lathe
- 1-spindle/2-turret lathe
- 2-spindle (main spindle and sub spindle)/1-turret lathe
- 2-spindle (main spindle and sub spindle)/2-turret lathes
- Lathe with Y-axis/C-axis machining functions
- Lathe with the function for tilt plane machining by a tool tilt axis
- Lathe with chasing tool
- Vertical lathe

2.1.3 Outline of the Conversational Automatic Programming Function

Machining types

In Super CAPi T, the following machining types can be determined automatically or selected manually:

- Outer surface machining
- Inner surface machining
- Grooving/residual machining
- Threading
- Cutting off
- Bar feed
- Center drilling/drilling/reaming/tapping
- C-axis center drilling/drilling/tapping
- C-axis front face nothing
- C-axis cylindrical grooving
- Y-axis center drilling/drilling/tapping(*1)
- Y-axis pattern machining(*1)
- Y-axis contouring(*1)
- Tilt plane center drilling, drilling, and tapping(*1)
- Tilt plane pattern machining(*1)
- Tilt plane contouring(*1)
- Auxiliary machining(*1)(*2)

NOTE

*1 Y-axis machining, tilt plane, and miscellaneous machining are not determined automatically.

*2 A subprogram can be called from the conversational program.

Basic menu screen

Operations with Super CAPi T always begin with the basic menu screen shown at the following. If the user cannot determine the next operation on a conversational screen, the user can press the leftmost soft key [ESCAPE] to return to the display of this basic menu screen.

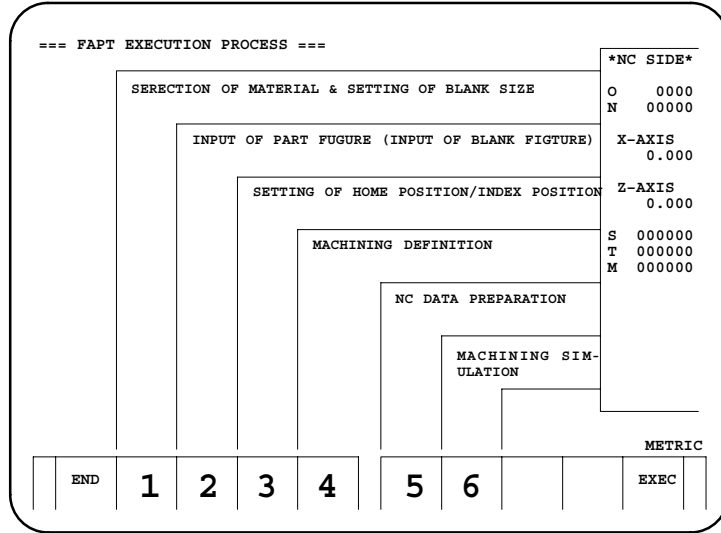

Material selection and blank size setting screen

When a size is entered, a guide figure can be drawn by pressing the [HELP] soft key.

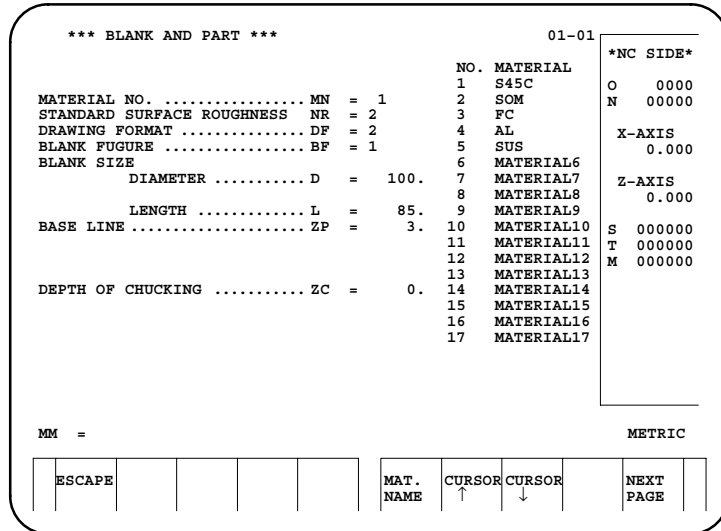

Part figure input screen

Part figures are input in a batch by using symbolic keys (\uparrow , \rightarrow , \downarrow , \leftarrow , \nearrow , \searrow , \swarrow , \nwarrow , \circlearrowleft , and \circlearrowright).

Functions are available for simplifying part figure input; these functions include the automatic intersection calculation, pocket calculator format numeric calculation, continuous groove input, chamfering batch input, and figure copy functions.

The input figures are displayed directly on the screen so that they can be checked easily.

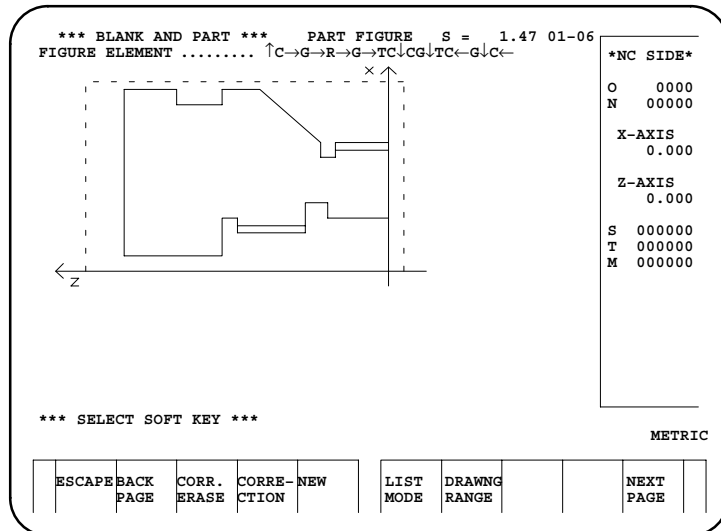

Process directory display

The automatic process determination function automatically creates the processes shown on the following.

The automatic process determination function automatically determines machining types, tool data, cutting areas, and cutting conditions.

On this screen, processes and edit operations (deletion and insertion of processes) can be selected manually.

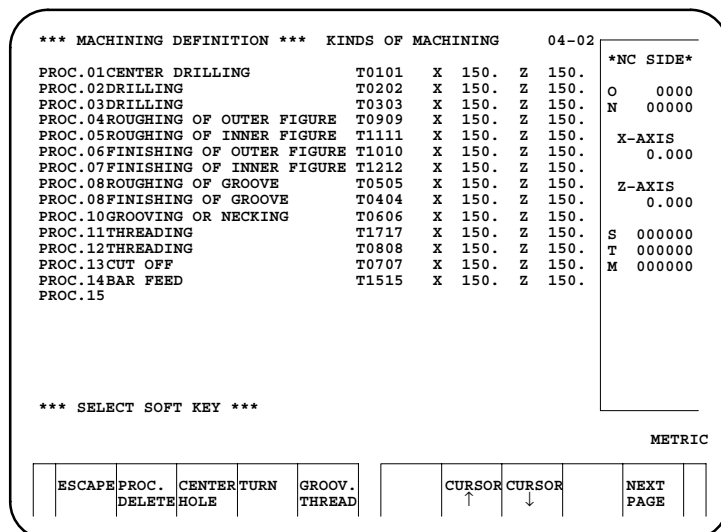

Tool data input screen

Tool data input and modifications are made on this screen. A tool currently selected is indicated on the screen, allowing the user to easily check tool data.

```

*** MACHINING DEFINITION ***      TOOL DATA      04-03
PROC.04 ROUGHING OF OUTER FIGURE T0909 X 150. Z 150.
MACHINING START POSITION:
TOOL SELECT NO. ... TN = 09      DX0 = 150.      Z0 = 150.
TOOL OFFSET NO. ... TM = 09
TOOL ID NO. .... ID = 500
TOOL TYPE .... TP ; GENERAL
NOSE RADIUS ..... RN = 0.8
CUTTING EDGE ..... AC = 8.
NOSE ANGLE ..... AN = 75.
PROTECTION ANGLE .. AP = 3.
VIRTUAL TOOL POS. XN = 0.8
                   ZN = 0.8
SETTING ANGLE .... AS = -90.
SETTING POSITION .. XS = 0.
                   ZS = 0.
HOLDER NO. .... ML = 13

*NC SIDE*
O 0000
N 00000
X-AXIS 0.000
Z-AXIS 0.000
S 000000
T 000000
M 000000

TN = METRIC

```

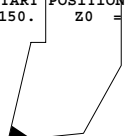

ESCAPE	BACK PAGE	TAB	NEXT TOOL	TOOL DATA	TOLING INFOR.	CURSOR ↑	CURSOR ↓	CHECK	NEXT PAGE
--------	-----------	-----	-----------	-----------	---------------	----------	----------	-------	-----------

Screen for setting cutting directions and cutting areas

Cutting directions and cutting areas are specified using the arrow keys. Any cutting direction and area can be specified.

```

*** MACHINING DEFINITION *** CUTTING AREA DEFINITION 04-05
PROC.04 ROUGHING OF OUTER FIGURE T0909 X 150. Z 150.
CUTTING DIRECTION ..... CD = ↓
CUTTING AREA DEFINITION:
START POINT ( 68. / 0. ) END POINT ( 27. / 0. )
DIVIDING DIRECTION ... DS = ↑ DIVIDING DIRECTION .. DE = ↓

*NC SIDE*
O 0000
N 00000
X-AXIS 0.000
Z-AXIS 0.000
S 000000
T 000000
M 000000

CD = METRIC

```

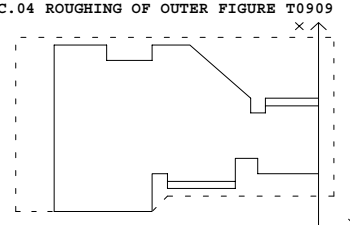

ESCAPE	BACK PAGE	↑	↓	→	←	CURSOR ↑	CURSOR ↓	DRAWING RANGE	NEXT PAGE
--------	-----------	---	---	---	---	----------	----------	---------------	-----------

Screen for setting cutting conditions

Cutting conditions are input or modified on this screen. The initial values are set automatically according to the parameters and blank material.

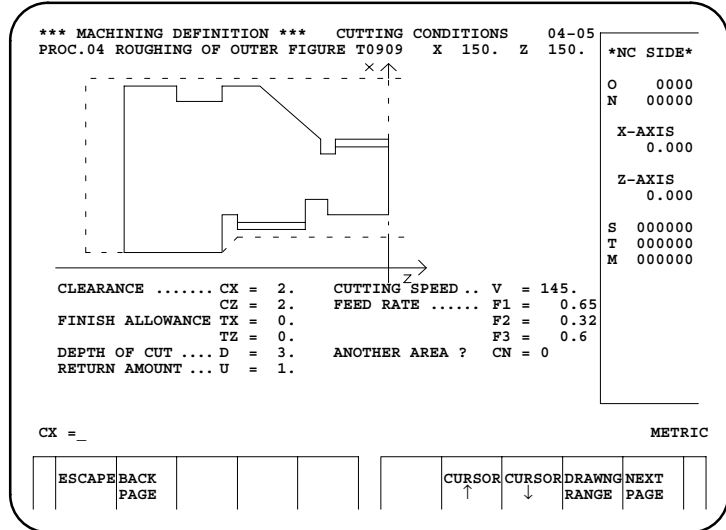

NC data creation screen

NC data appears, and a tool path is drawn on this screen, allowing the user to easily check NC data. Switching between animated simulation and tool path drawing is enabled with a soft key.

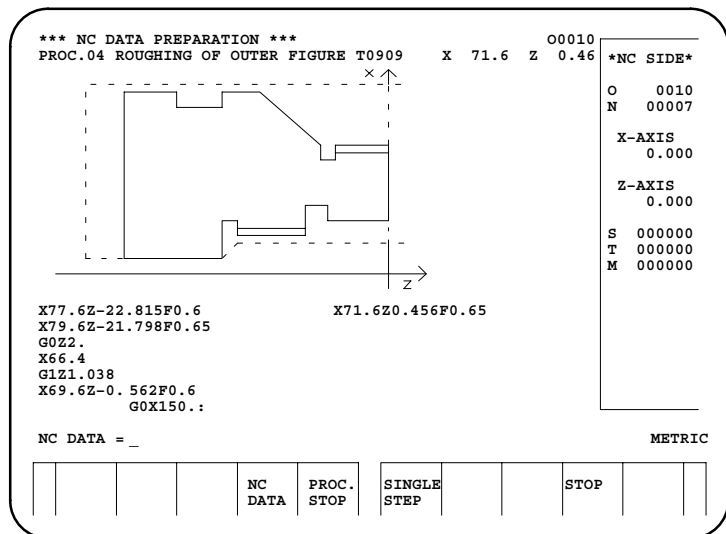

Machining time display screen

The cutting time and rapid traverse time are displayed for each machining type. A bar chart is displayed so that the user can check the time allotment at a glance.

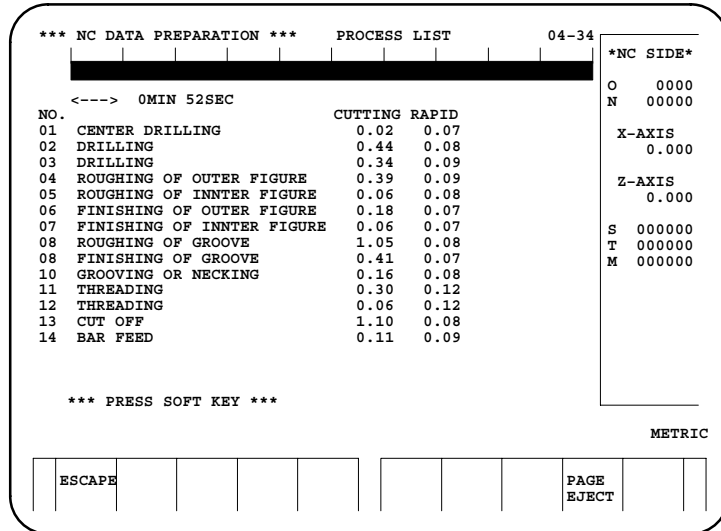

Animated simulation screen

The user can check the memory operation conditions on the screen. A function for checking for interference between the chuck/tailstock and tool is provided. An interference check can be made before actual operation by performing memory operation with the machine lock set to ON.

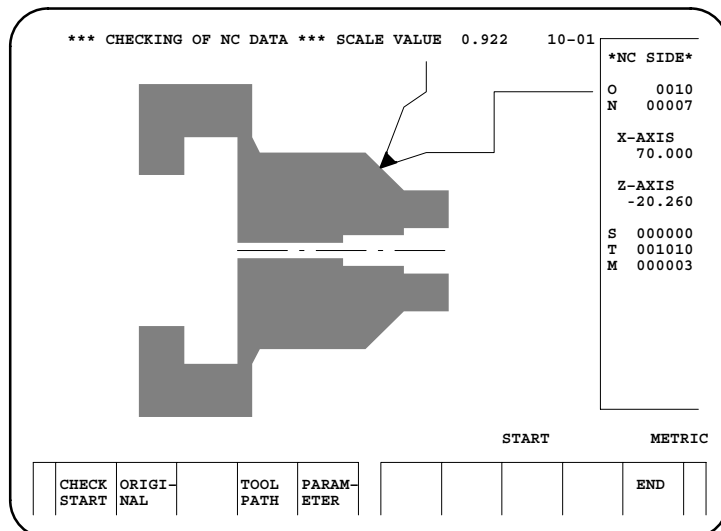

2.2 Super CAPi T

2.2.1 Features

Super CAPi T is conversational automatic programming functions a for lathes. It has the following features:

- Simple operation
- Program input by selecting machining processes
- Conversational setup operation by following displayed setup instructions
- Direct execution of conversational programs. The program can also be converted to an NC format, then executed.
- Customization by the machine tool builder.

About Super CAPi T

Super CAPi T is a development of Super CAP T for Series 16i/18i-TA. It features the following new functions:

- 1 Background color for the display screen, and 3-D frames for windows and soft keys
- 2 Buttons appear “pressed” when selected
- 3 Machining simulation for turning based on a solid model (Super CAP T for Series 16i/18i-TA can be used this function)
- 4 Tool trajectory drawing based on isometric projection in C-/Y-axis machining simulation (Super CAP T for Series 16i/18i-TA can be used this function)
- 5 Selectable screen display colors, with the saving of up to four color schemes supported

All other functions, such as screen displays, key operations, and machining functions, are the same as those of super CAP T. Moreover, machining programs, tool data, and conversational function parameters created with Super CAP T can also be used with Super CAPi T.

2.2.2 Applicable Machines

Super CAPi T can be used with the following lathes:

- 1-spindle/1-turret lathe
- 1-spindle/2-turret lathe
- Facing 2-spindle/2-turret lathe (The two turrets operate independently of each other.)
- 2-spindle (main spindle and sub spindle)/1-turret lathe
- Lathe with Y-axis/C-axis machining functions
- Composite lathe (facing 2-spindles/2-turret type lathes)
- Composite lathe (facing 2-spindles/3-turret type lathes)

2.2.3 Outline of the Conversational Automatic Programming Function

Machining types

In Super CAPi T, the following machining types can be selected:

- Bar machining (External diameter/External diameter+automatic residual/Internal diameter/Internal diameter+automatic residual/End face/End face+automatic residual)
- Pattern repeating (External diameter/Intermediate of external diameter /Internal diameter/Intermediate of internal diameter)
- Residual machining (External diameter/Internal diameter/End face/End of internal bottom)
- End facing
- Threading (External diameter/Internal diameter)
- Grooving (External diameter/Internal diameter/End face)
- Necking
- Center drilling/drilling/reaming/boring/tapping
- Single action

NOTE

A command equivalent to one block of an NC program can be input conversationally.

- Subcall

NOTE

A subprogram can be called from the conversational program.

- Auxiliary processes and transfer process

NOTE

The machine tool builder can include machine-specific operations in the conversational function.

- M code/end process
- C-axis center drilling/drilling/reaming/boring/tapping (End face/Side face/Incline face *1)
- C-axis grooving (End face/Side face)
- C-axis nothing (End face/Side face)
- C-axis cylindrical machining
- Y-axis center drilling/drilling/reaming/tapping (End face/Side face/Incline face *1)

- Y-axis milling (End face/Side face/Incline face *1)
- C-axis milling machining (End face/Side face)
- Balance cut (External diameter/Inside of external diameter (Residual of external diameter)/Reverse of external diameter/Reverse of residual of external diameter)

NOTE

1 These operations are enabled by the B-axis conversational programming function that is an optional function.

Basic menu screen

Operations with Super CAPi T always begin with the basic menu screen shown here. If the user cannot determine the next operation on a conversational screen, the user can press the leftmost soft key  to return the display to this basic menu screen.

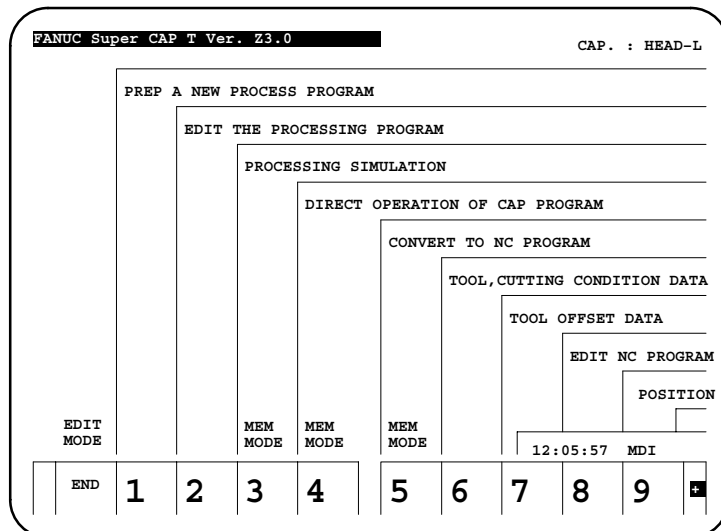

Conversational program input screen

A program can be input easily by following the instructions displayed in a window.

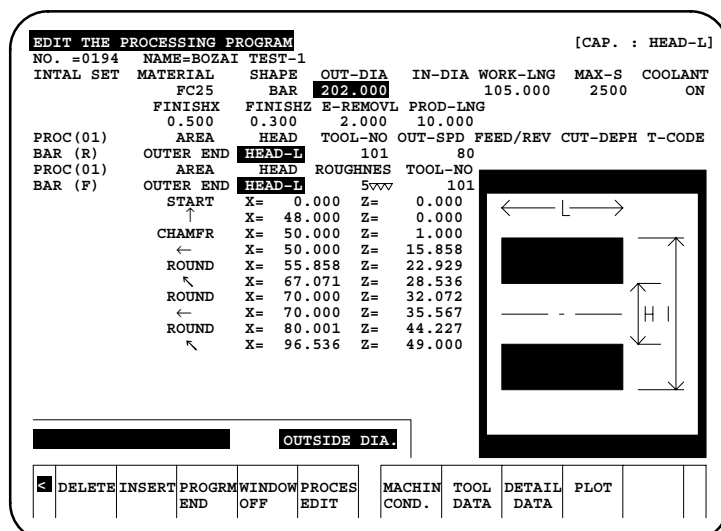

Conversational program input screen (inputting a machining profile)

A machining profile can be input easily by using intersection automatic calculation and pocket calculator format calculation. The input profile is displayed directly on the screen so that the user can check the profile easily.

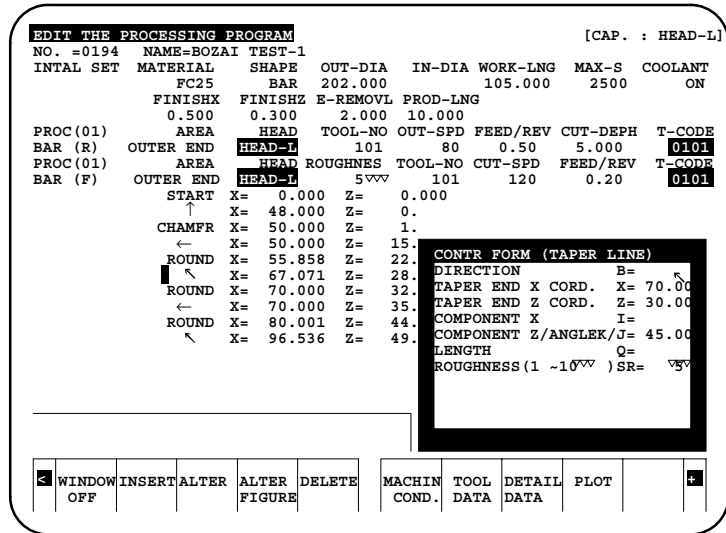

Process directory display screen

The entire machining program can be checked easily from the process directory display screen that also indicates the execution time for each process. In addition, editing operations including movement, copy, and deletion of processes can be performed on this screen.

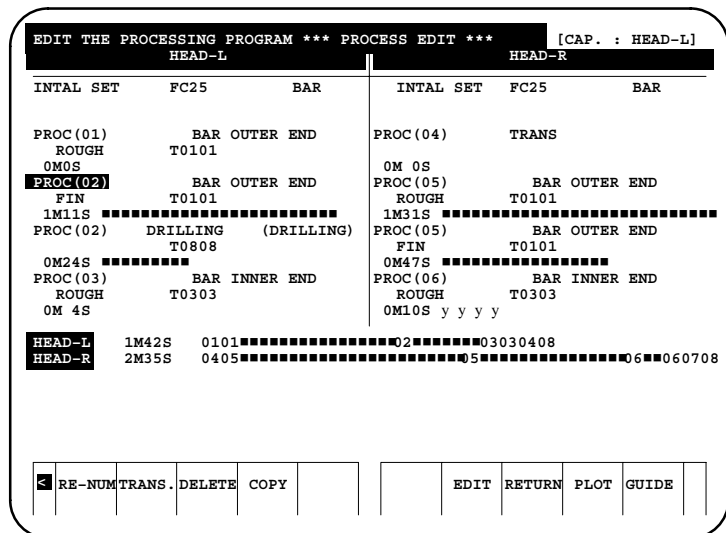

Program directory screen

Programs created conversationally are listed on the program directory screen. The user can choose from these programs. The figure produced by a specific program can be displayed in a window for checking.

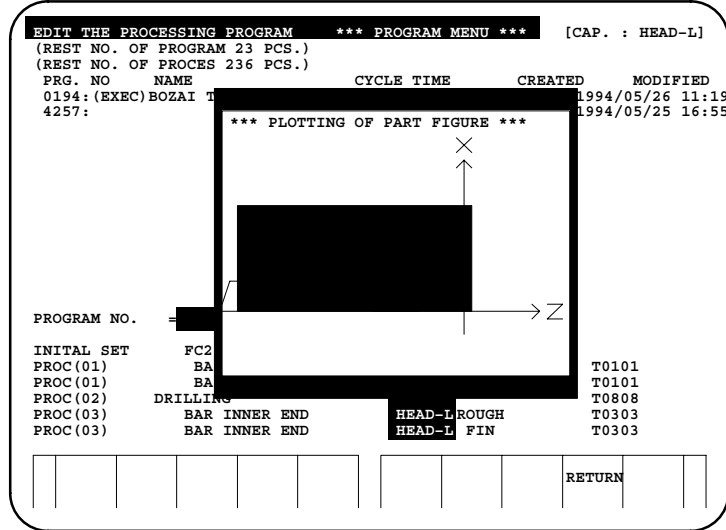

Tool/cutting condition/ pre-tool automatic determination

Tool data, cutting condition data, and pre-tool data can be input easily by following the instructions displayed on the screen. Once data is input, necessary data for machining is determined automatically.

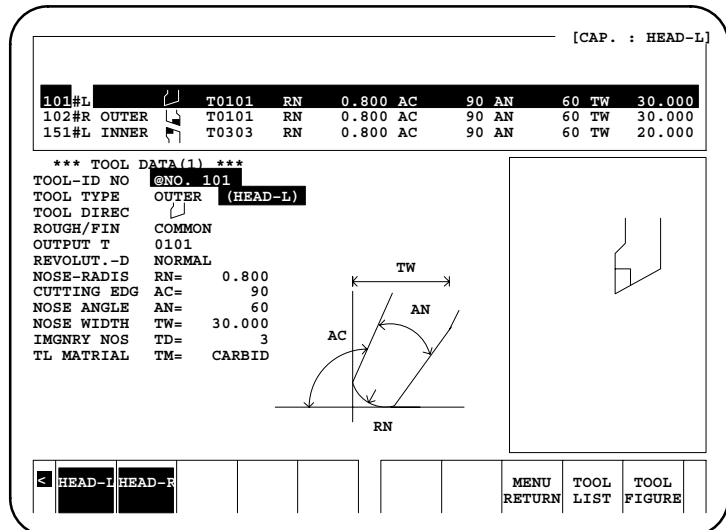

Tooling screen

Tool assignment to the turret and tool offset measurement for each tool can be performed easily on the tooling screen which lists the tools used in the machining program.

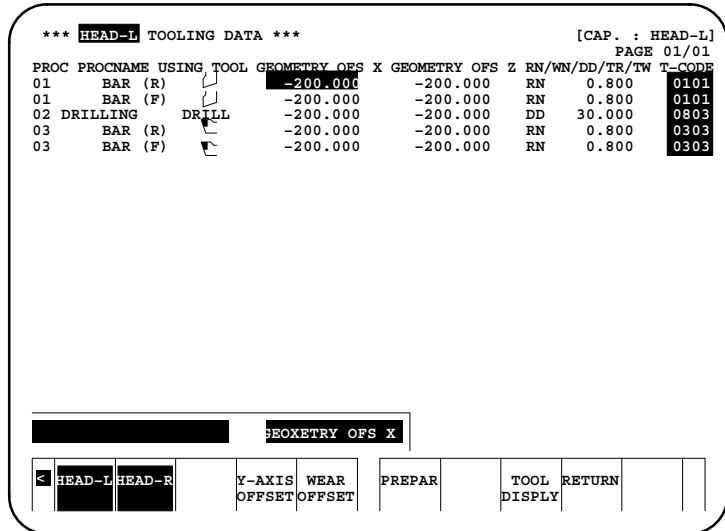

Setup instructions

By following the setup instructions displayed conversationally, tool geometry compensation, tool-change position, chuck barrier, and tailstock barrier can be set easily.

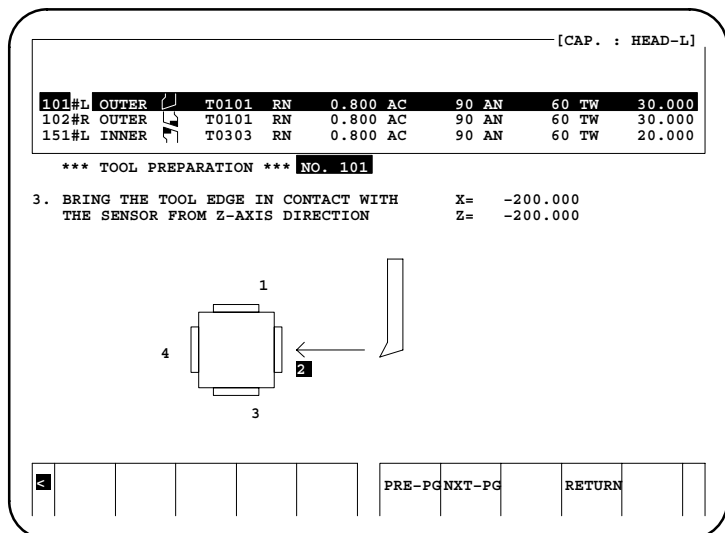

NC program output function

The machining program created conversationally can be run directly. The program can also be converted and executed as an NC program. Furthermore, when modifications are made to the NC program obtained by the conversion, a much more efficient machining program can be created.

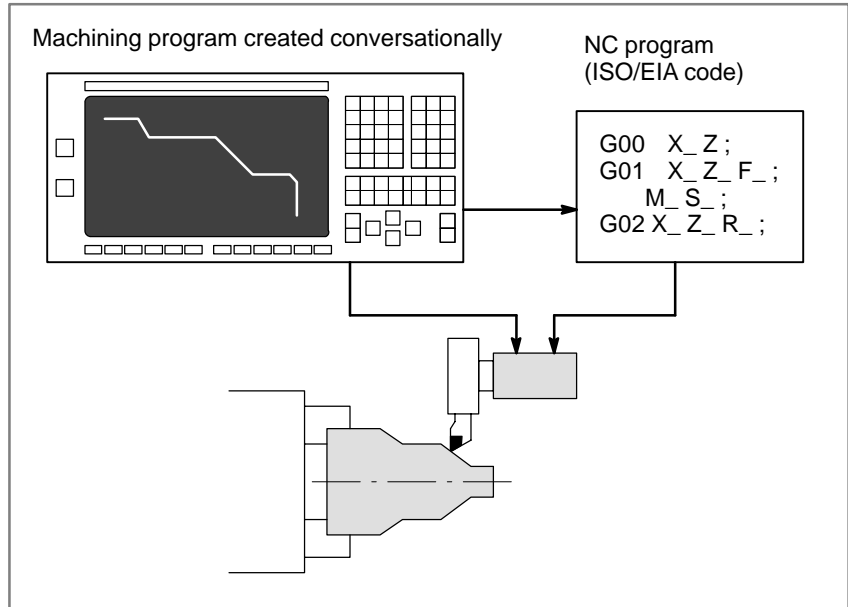

Machining simulation

A variety of machining simulations, such as simultaneous animated simulation for the facing 2-spindle 2-path lathe, animated simulation for the 1-spindle/2-turret 2-path lathe, and animated simulation of C-axis/Y-axis machining can be performed.

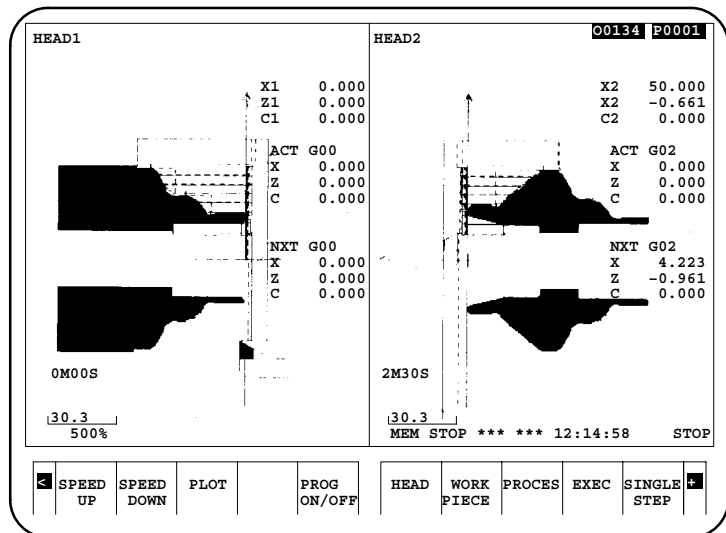

Adding machine-specific unique know-how

By using the software package provided for the macro compiler/executor, auxiliary operations specific to the machine, such as measurement on the machine, bar feeder, cutting-off, and transfer of blanks, can easily be included in the conversational function. The newly added processes can be displayed and edited the same as with other existing processes.

2.3 MANUAL GUIDE

2.3.1 Features

The manual guide displays instructions for guiding the operator step by step through the operations of a new machine. It enables the operator to learn all types of operations, from simple handle-based cutting to complicated machining.

The displayed instructions form three machining manipulation steps, each of which can be used according to the learned level of the operator.

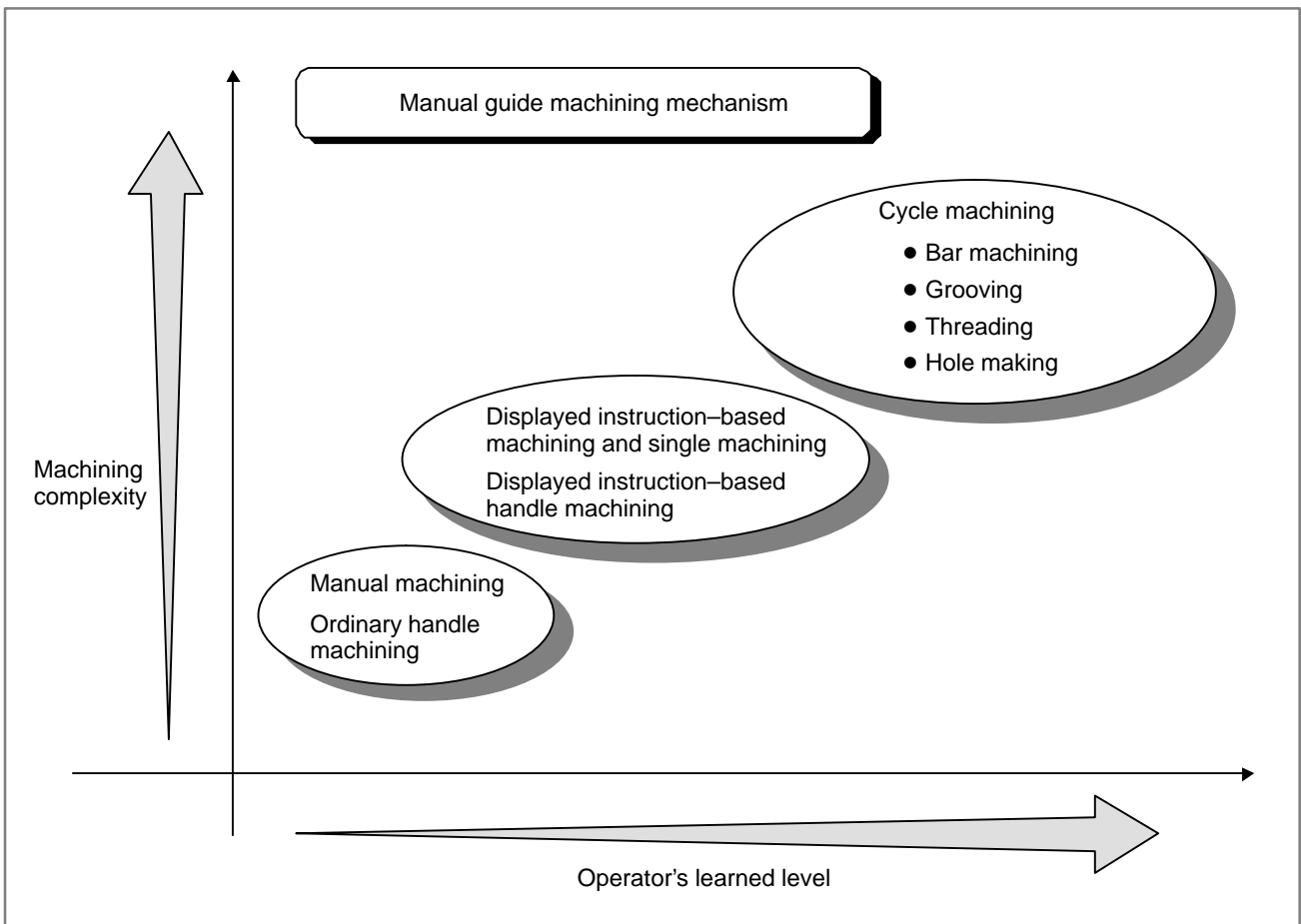

Manual machining

As the first step of using a newly introduced machine, the operator can perform longitudinal and radial cutting or hole making using ordinary X-axis and Z-axis handles without entering a machining program.

These handles can be used at any time provided that the manual guide screen is displayed and no automatic operation or animated simulation is selected. With these handles, the operator can perform manual machining while watching the display of the machine current position on the screen.

All operators who are familiar with the operation of general-purpose lathes having mechanical handle feed mechanisms can perform this manual machining without feeling out of place.

The machine operator's panel is equipped with switches for auxiliary functions such as spindle rotation and tool change in addition to tool movement.

The manual guide does not require mode switching unlike ordinary NC units. Usually the JOG and handle modes are selected. Operating a different type of manual guide operation directs the PMC to select a necessary mode, hence automatic mode switching. Therefore, the operator can perform various operations easily without bawaring of mode switching.

Displayed instruction-based machining and single machining

As the second step of learning how to operate, the operator can perform slant-line and circular cutting using the displayed instruction-based handle.

The following two operation types are available in this step.

1) Displayed instruction-based machining

Supplying data for linear or circular cutting enables approaching, linear, or circular machining.

Recording these machining operations in the CNC's memory by teaching enables them to be used repeatedly as a playback operation program. In addition, using the synchronous feeding function of the displayed instruction-based handle during playback operation enables controlling of tool movement.

2) Single machining

Supplying tool paths for rapid traverse, linear, and circular movement one by one enables execution of the respective machining operations. In addition, using the synchronous feeding function of the displayed instruction-based handle enables controlling of tool movement.

When supplying a tool path, you can use simple figure end point calculation.

Similarly to single machining, these machining operations can be taught and used repetitively as playback operation.

In addition to these machining functions, the auxiliary function switches (such as spindle rotation and tool change) on the machine operator's panel can be used in the same manner as for the manual machining stated in the previous item. Moreover, the auxiliary functions and the above machining operations can be taught together.

Cycle machining

As the third step of learning how to operate, the operator can cause complex machining to be automatically executed simply by entering necessary data to cyclic machining.

The following types of cyclic machining are available.

- 1) Bar machining (outer, inner, and end surfaces)
- 2) Grooving (ordinary and trapezoidal grooves)
- 3) Threading (general, metric, inch, PT, and PF threads)
- 4) Hole making (center drilling, hole making, reaming, and boring)
- 5) Tapping
- 6) C-axis machining type A (C-axis hole making and C-axis grooving)

A powerful contour calculation function is available especially for bar machining, so arbitrary contour figures can be entered.

In these cyclic machining processes, the necessary auxiliary functions such as spindle rotation and tool change are output automatically. The operator need not manipulate these auxiliary functions on the machine operator's panel.

2.3.2 Supported Machine Tools

Because of a basic concept of simple machining, the manual guide supports the following simple lathes:

- Single-spindle/single-tool post lathe (X- and Z-axes)
- Single-spindle/facing-tool post lathe (X- and Z-axes)
; the X negative range machining option is required.
- Single-spindle (with C-axis)/single-tool post lathe (X-, Z-, and C-axes) ; the C-axis machining type A option is required.
- Single-spindle/rear-side tool post lathe (x12 axes)
; the option for supporting rear-side tool post lathes is required.

The manual guide can also apply as a simple conversation function to rear-side tool post lathes (CNC lathes) by limiting machining to cycle machining only except guidance single machining with the guidance handle.

2.3.3 Operation

The following flowchart shows the entire manual guide procedure from preparation for machining to playback operation.

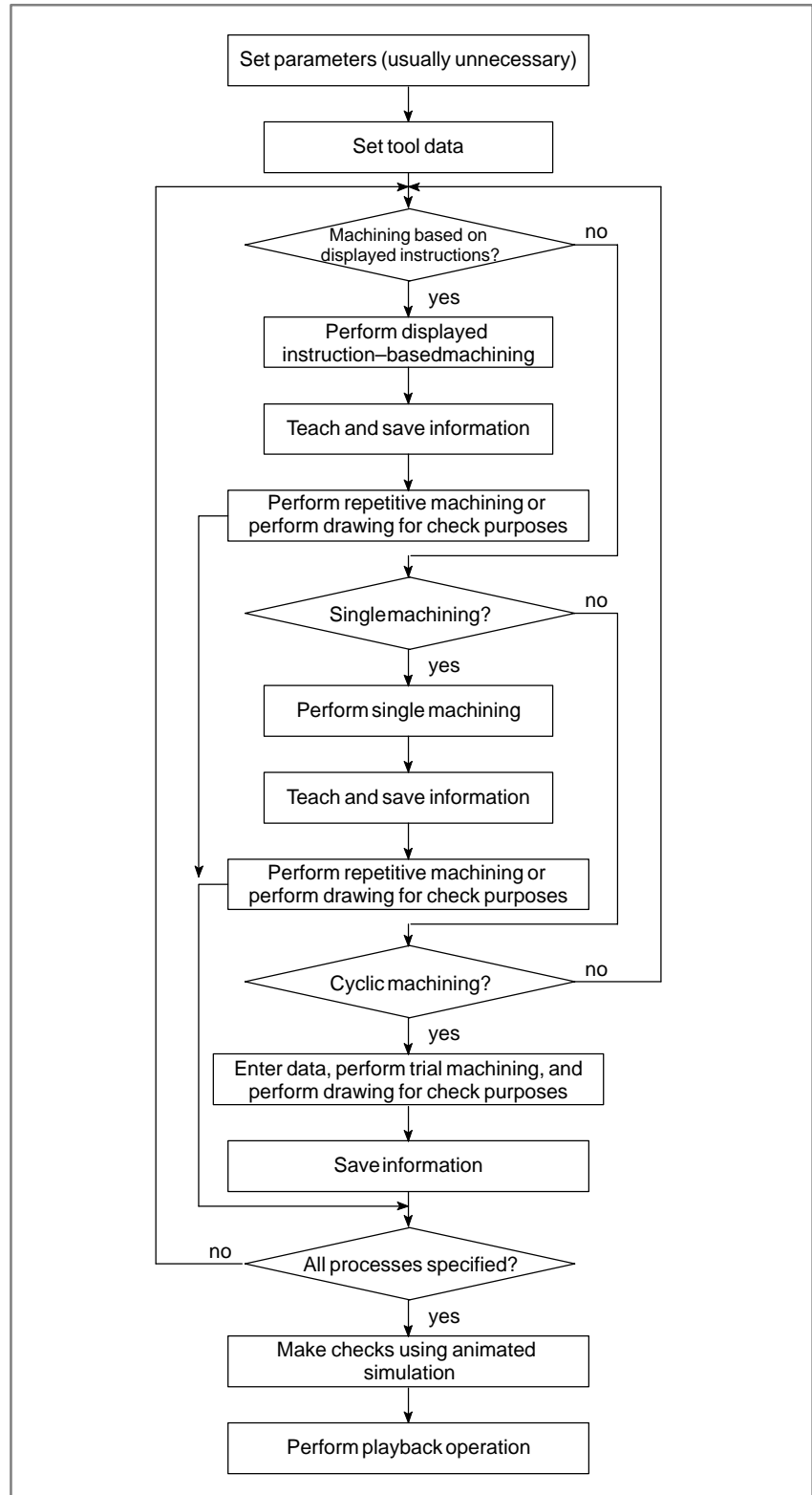

2.3.4 Display Screen

The major feature of the manual guide is that all operation types can be specified on a single screen.

The single display screen of the manual guide consists of a status display window for displaying data (such as current position and spindle rotation speed) necessary for operations, graphic window for displaying entered figures and drawings for animated simulation, and program window for entering and displaying machining programs.

The soft key menu for selecting machining and manipulation types is accompanied by icons representing the respective types, thus enabling the operator to understand them easily.

Screen example 1) Manual guide operation screen

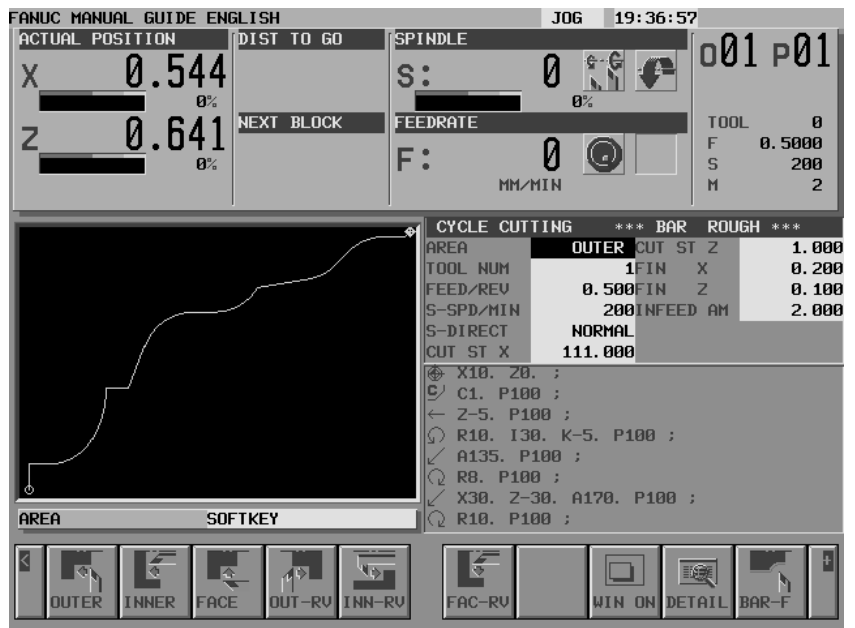

When machining data is entered, a window is displayed on the screen as required.

Screen example 2) Window for entering data for displayed instruction-based machining

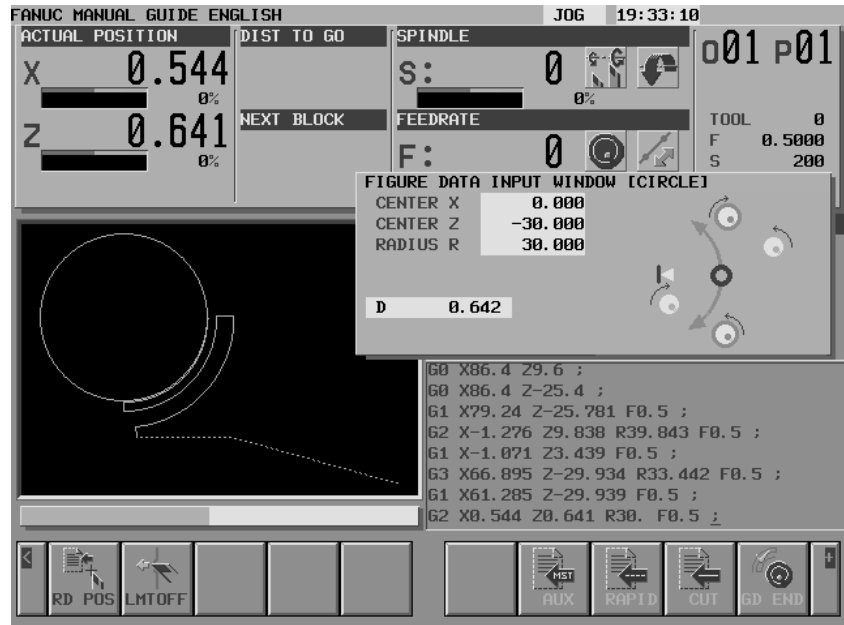

The same screen can also be used for solid model-based machining simulation.

Screen example 3) Machining simulation

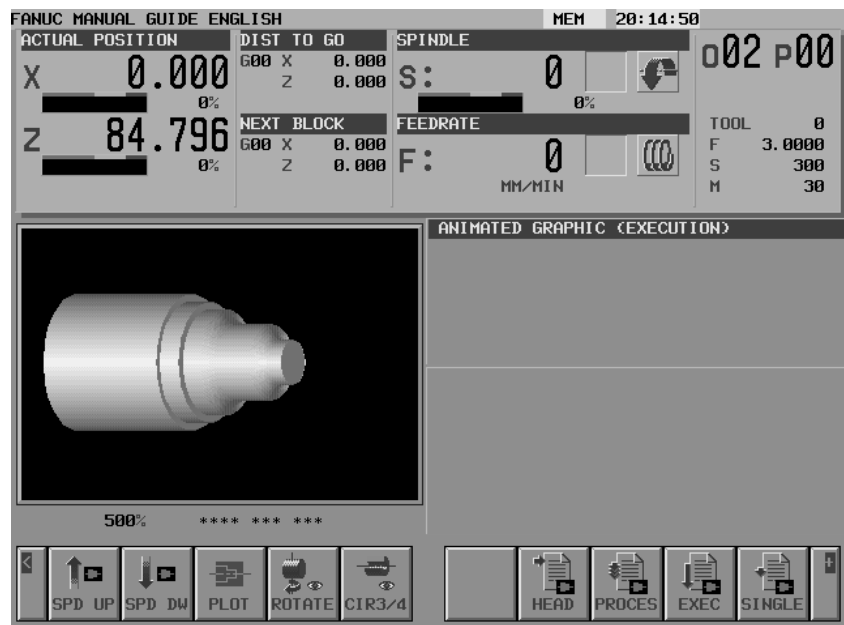

A list of created and registered machining programs can be displayed in a window.

Screen example 4) Program list window

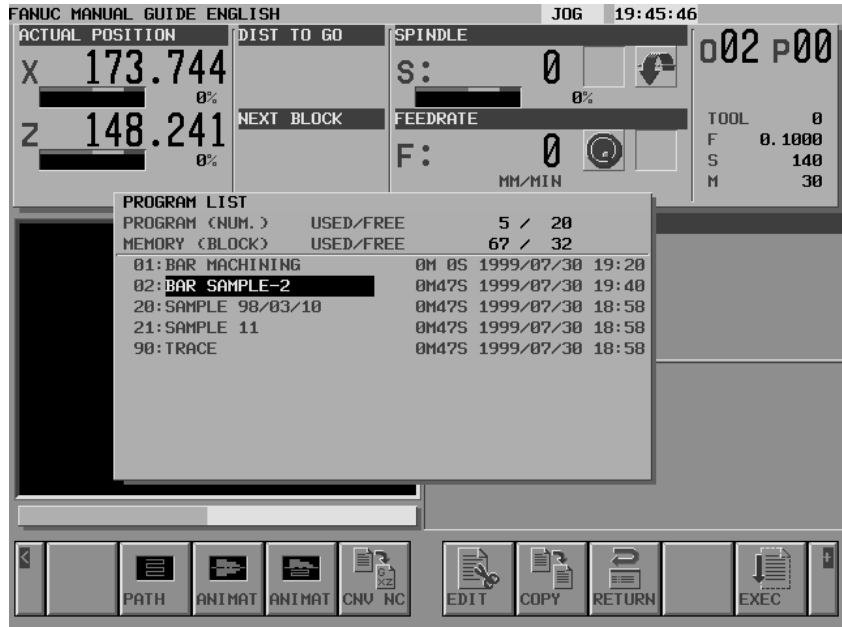

The instructions for measuring workpiece end face positions required in setting up lathing are also displayed in a window.

Screen example 5) Window for displaying instructions for workpiece end face measurement

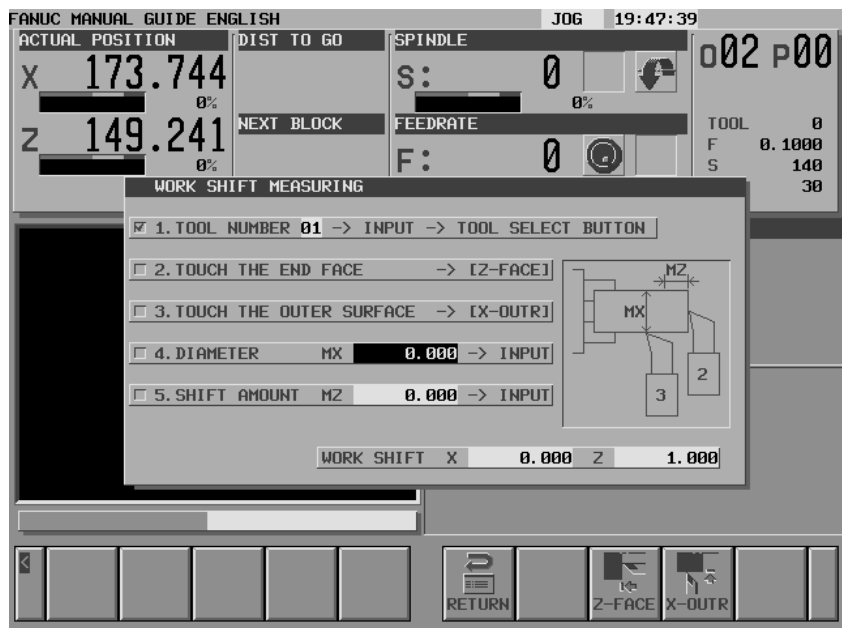

3

CONVERSATIONAL AUTOMATIC PROGRAMMING FUNCTION FOR MACHINING CENTERS

Super CAPi M and MANUAL GUIDE are provided as the conversational automatic programming function for machining centers. As with Super CAPi T and Super CAPi M use a machining process selection method for input.

With the manual guide, widely used G code programs can be created easily by selecting menu items with pictorial representations.

For the 160i/180i/210i, use the CNC screen display function.
For the 160is/180is/210is, this function is unavailable.

3.1 Super CAPi M

3.1.1 Features

Super CAPi M is performed by using conversational control software and a custom macro program. In Super CAPi M, therefore, many macro instructions dedicated to conversational operation are provided as well as the standard custom macro instructions. FANUC supplies a standard macro library to the machine tool builder. The machine tool builder can make additions and modifications to the standard macro library to develop unique functions. The following sections explain the specifications of the conversational automatic programming function of the standard macro library supplied by FANUC.

3.1.2 Outline of the Macro Library

Machining type

In Super CAPi M, the following machining types can be selected:

- Drilling (eight types + hole position menu: Nine types)
- Facing (six types)
- Side facing (eight types including contour side)
- Pocketing and grooving (eight types including contour pocketing)
- 2 + 1/2 machining (eight types)
- NC language (eight types)
- Machining of multiple workpieces (five types)
- U axis machining (eight types)

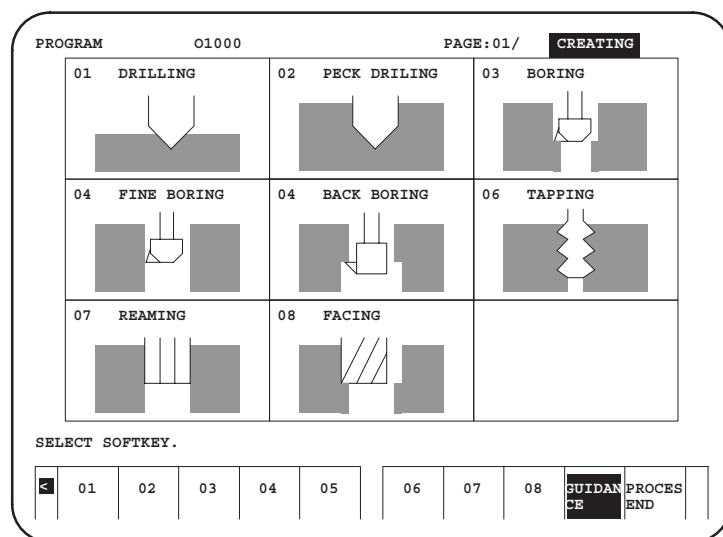

Conversational program input screen

An easy-to-understand guide figure and message are displayed for each input item on the screen.

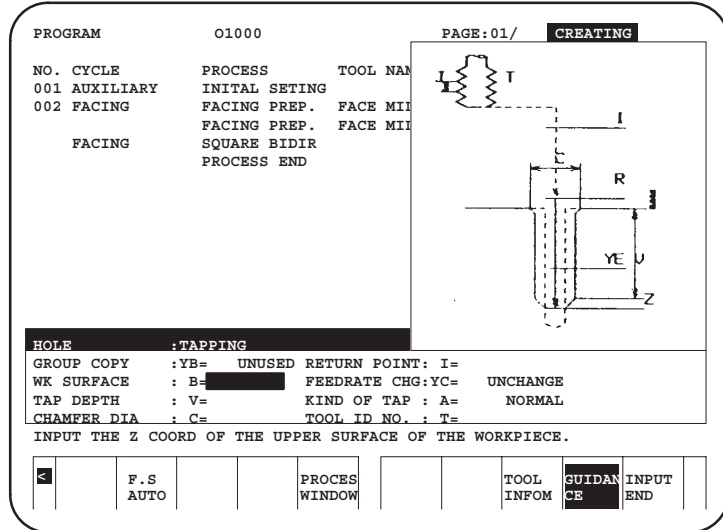

Tool/cutting condition/ pre-tool automatic determination

Tool data, cutting condition data, and pre-tool data can be input easily by following the instructions displayed on the screen. Once data is input, necessary data for machining is determined automatically.

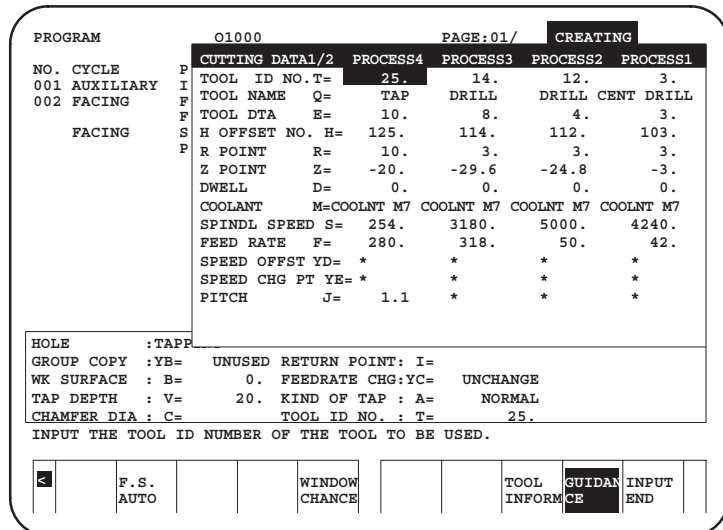

Conversational program input screen (inputting contours)

Even a complicated machining profile can be input easily by using the symbolic input and automatic intersection calculation functions. The input profile is displayed directly on the screen so that the user can easily check the profile.

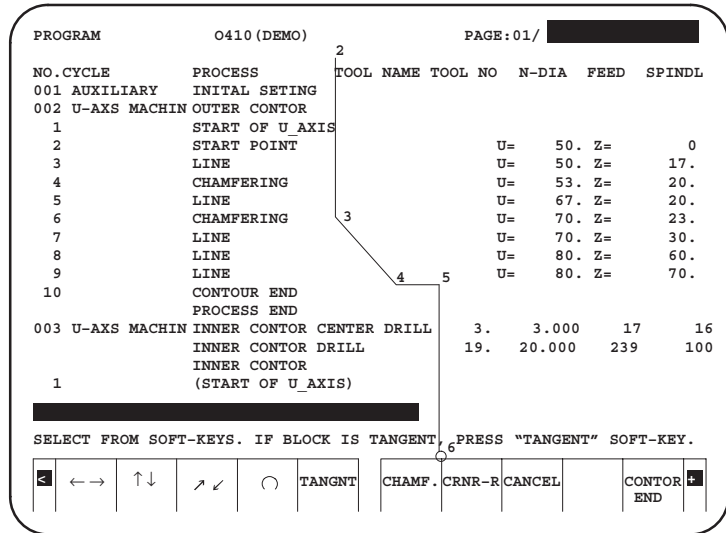

Conversational program editing screen

Programmed data is listed in an easy-to-understand form. On this screen, editing operations such as movement, copy, and deletion of processes can be performed.

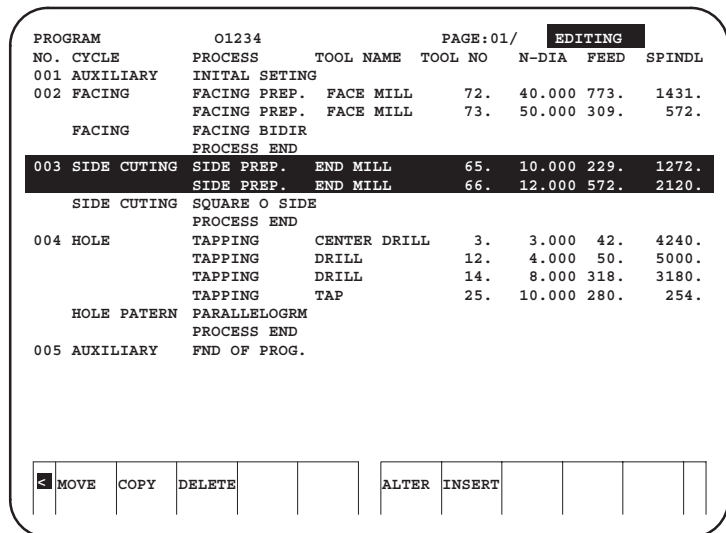

Process optimization edit function

The machining order can be changed automatically to reduce the number of times tools are changed. The machining order can also be specified manually.

With these functions, the time required for machining can be reduced.

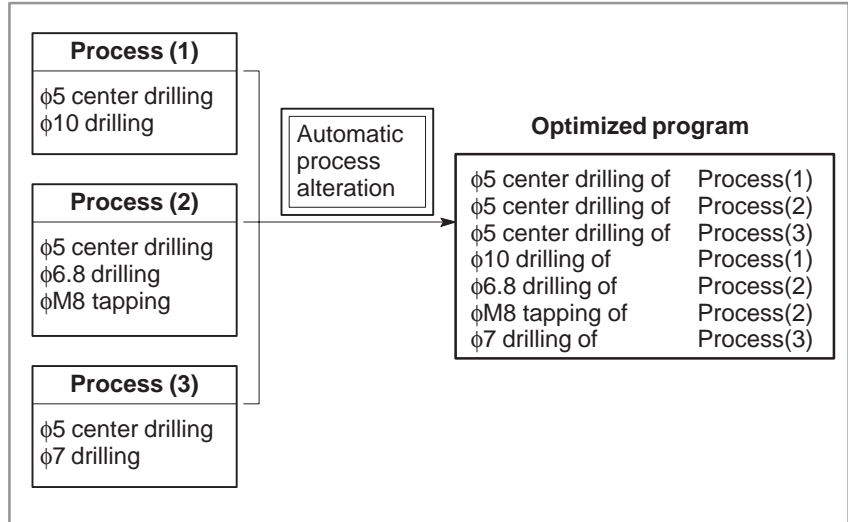

Full graphic function

Machining profiles, tool figures, and tool paths can be drawn in the isometric mode, biplane drawing mode, and so forth.

In addition, an animated simulation function is provided to display a solid drawing of the workpiece figure to be machined.

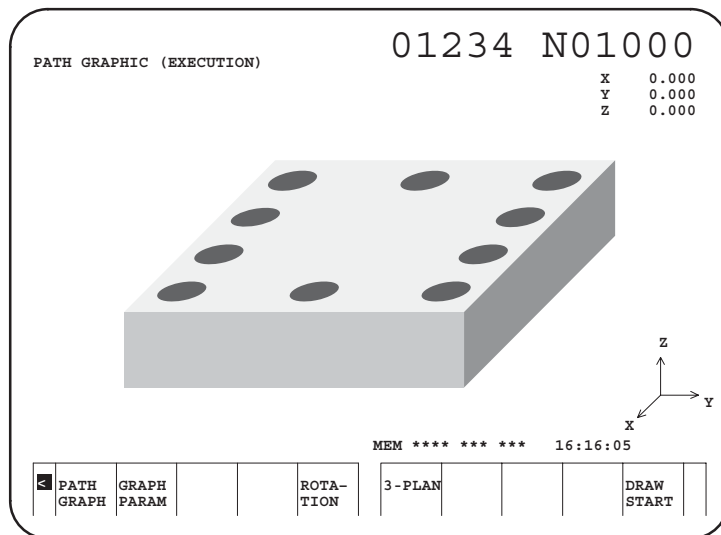

3.1.4 Other Optional Functions

NC program output function

A machining program created conversationally can be run directly. The program can also be converted and then executed as an NC program form. Furthermore, when modifications are made to the NC program obtained by the conversion, a more efficient machining program can be created.

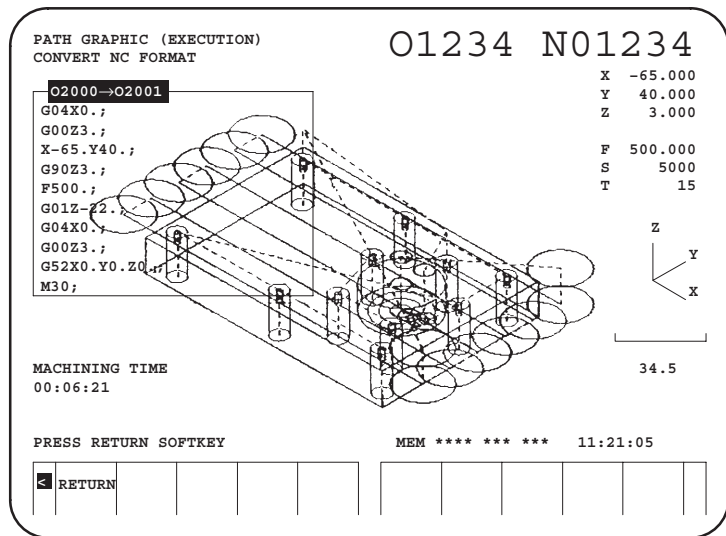

Contour repeat function

In programming for an arbitrary figure, a certain section of a figure can be repeated more than once. Three types of repetitions are available: Inversion, rotation, and parallel displacement. By combining these types, program data can be utilized more than once in a program.

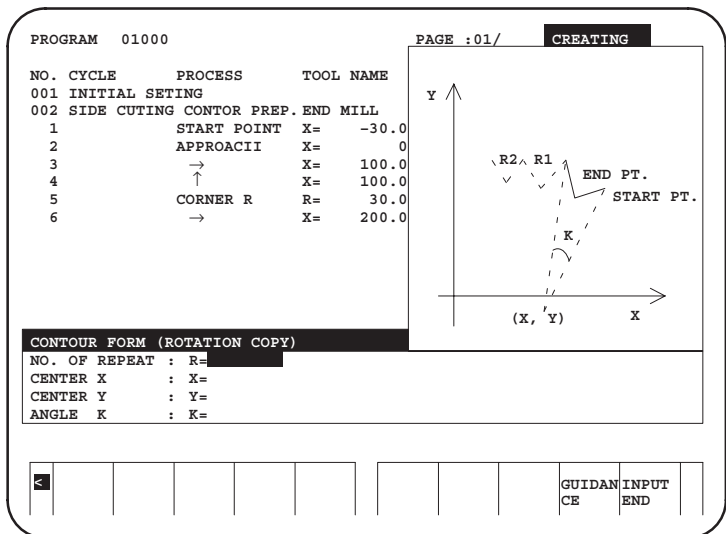

Background drawing function

A machining program can be created and checked using the drawing function while another program is being executed for machining. By using this function, the NC can be used more efficiently.

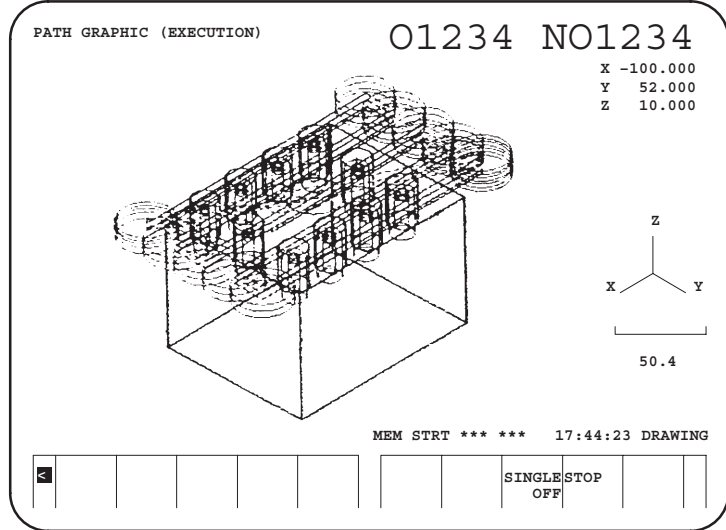

U-axis conversational function

Programs for the following cutting operations with the lathe can be input conversationally:

- Contouring (outer surface/inner surface/end face)
- Grooving (outer surface/inner surface/end face)
- Threading (external/internal)

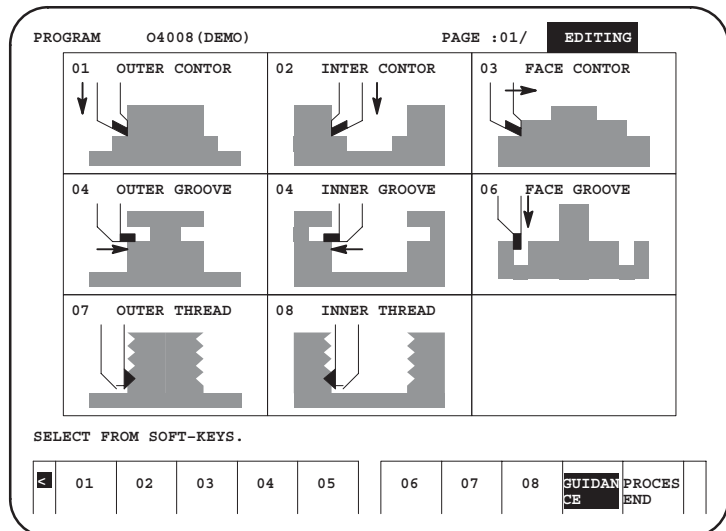

In addition, simulation for the machining profile, removal, tool path, and others functions are enabled during cutting.

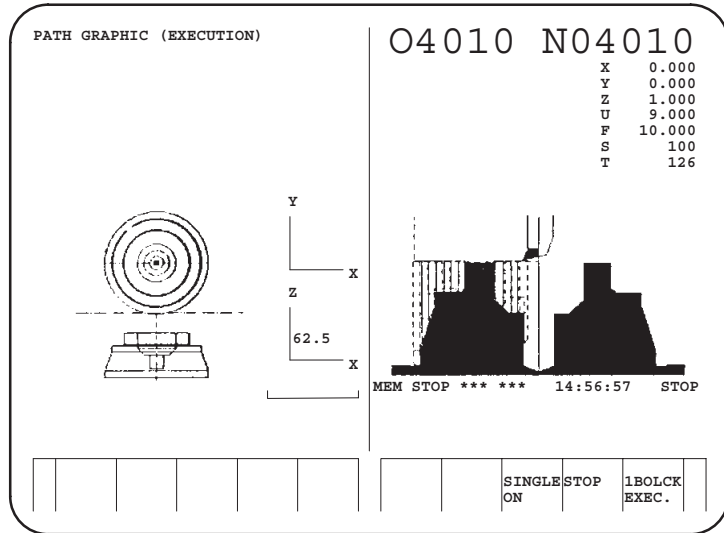

Conversational C language programming function

When a custom macro program is replaced with a program coded in C, programs such as those for automatic tool setting and automatic cutting condition setting can be executed at high-speed. Programs are developed on a personal computer.

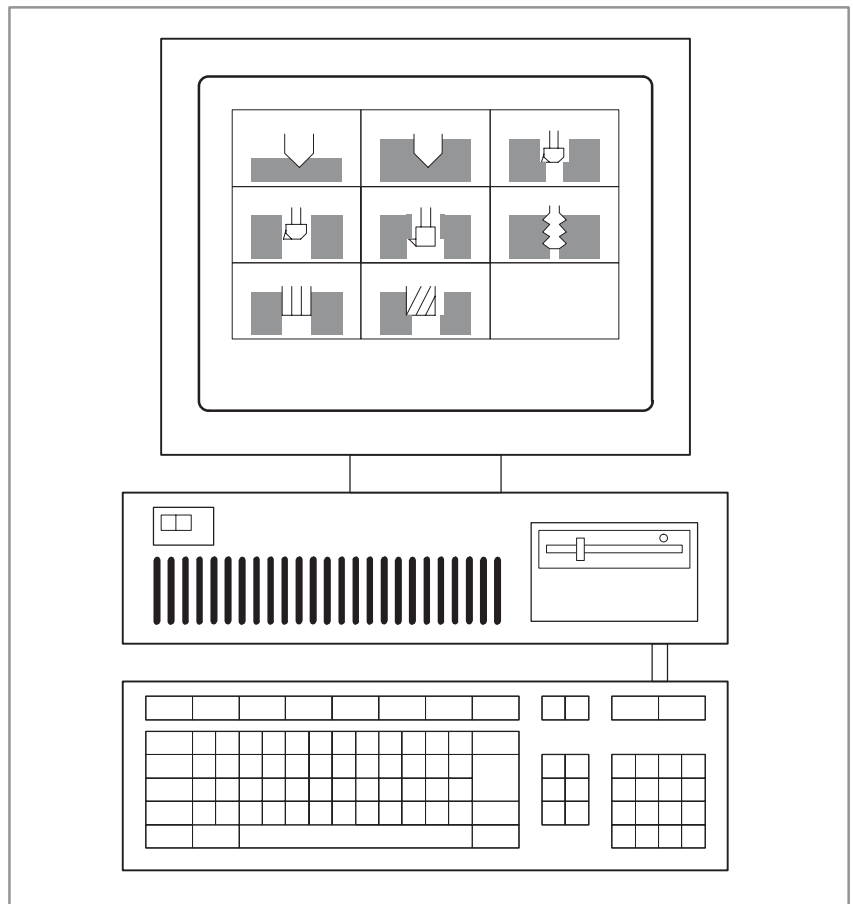

3.2 MANUAL GUIDE

3.2.1 Features

By using the manual guide, the operator can perform many types of machining from simple handle-based cutting to complicated machining as follows:

Handle-based machining (optional)

With the guidance handle, a tilt straight line and an arc can be machined.

Furthermore, these machining operations can be taught and stored in a form of machining programs for playback operation so that they can be performed repeatedly.

In addition, during playback operation, the guidance handle synchronization feed function can be used to control the tool movement.

Canned-cycle machining

The following canned cycles can be specified to automatically perform complicated machining:

- (1) Drilling
- (2) Drilling pattern
- (3) Facing
- (4) Side facing
- (5) Pocketing and grooving
- (6) Contouring

The manual guide has the following features for easily creating complicated G code programs (ISO programs) in conversational mode:

1) Menu selection

The complicated G code system is systematically classified into several menus so that the operator can select these G code menus to create G code programs easily.

2) Display of guidance diagrams and items in windows

According to the input data, appropriate guidance diagrams and items are displayed in windows as necessary to support operator's input.

3) Checking of an entered program

After entering a program, the operator can check it easily through machining simulation. Since the machining program and tool path are displayed on the screen at the same time, the operator can check the entered program easily.

4) Easy operation by menus with pictorial representations

Soft keys with pictorial representations are used for all menu items, so the operator can easily understand the menu items.

5) Many canned cycles

Canned cycles for milling such as drilling, side facing, and pocketing are prepared. The operator only needs to enter a desired G code; then complicated machining can be performed automatically.

3.2.2 Operation

A general procedure with the manual guide from preparation for machining to operation is shown below.

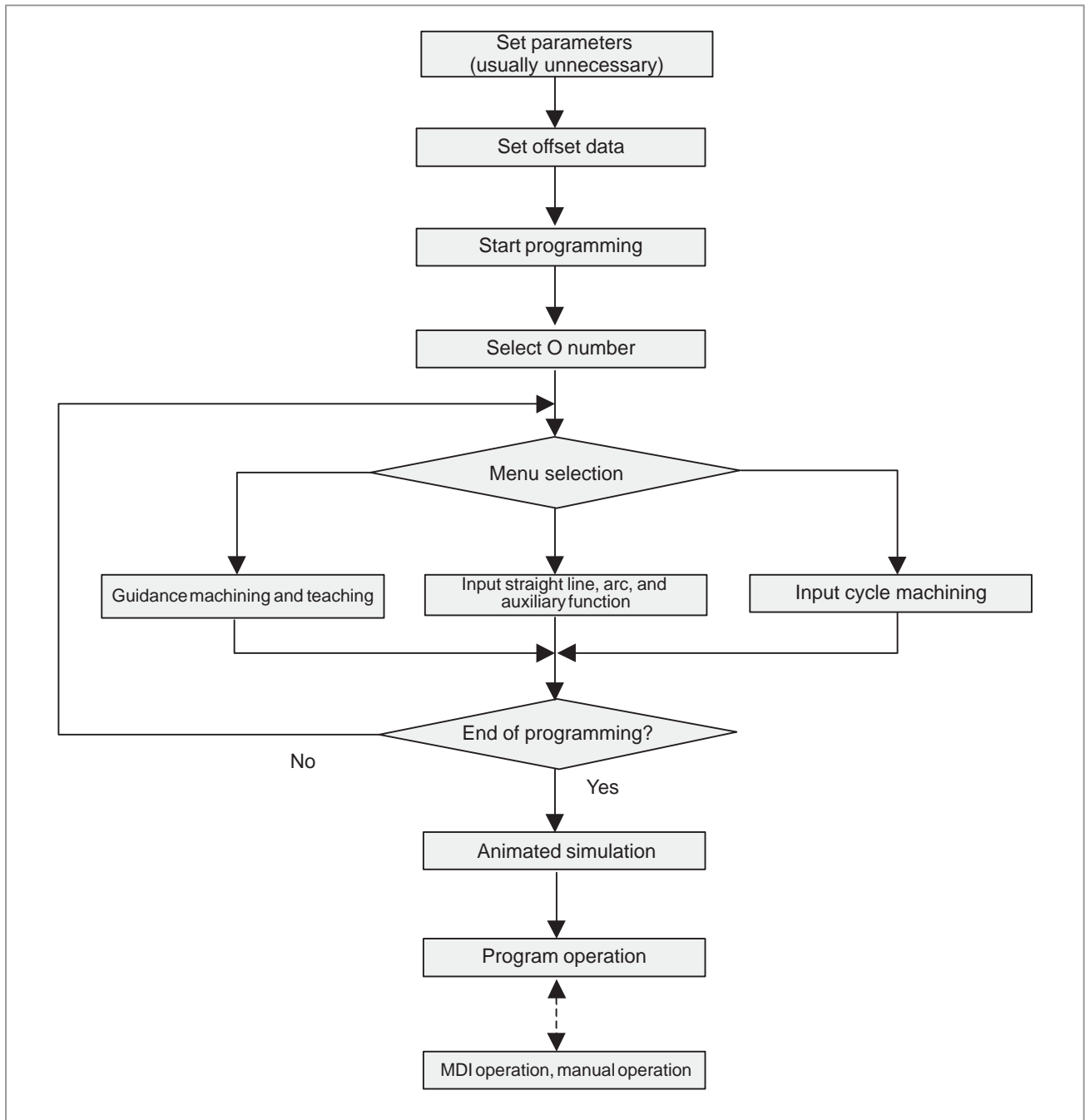

3.2.3 Display Screen

The major feature of the manual guide is that all operations can be specified on a single screen.

The manual guide displays necessary information for a given operation on a single display screen that consists of windows such as a status display window for displaying necessary data for the operation such as the current position and spindle speed, a graphic window for displaying entered figures and drawings for animated simulation, and a machining program window.

The soft key menu for selecting machining and manipulation types is accompanied by icons representing the respective types, thus enabling the operator to understand them easily.

Screen example 1) Manual guide operation screen



When machining data is entered, a pop-up window is displayed on the screen as necessary.

Screen example 2) Window for entering drilled-position pattern data



Machining simulation with a solid model can also be performed on the same screen.

Screen example 3) Machining simulation



A list of created and registered machining programs can be displayed in a window.

Screen example 4) Program list window

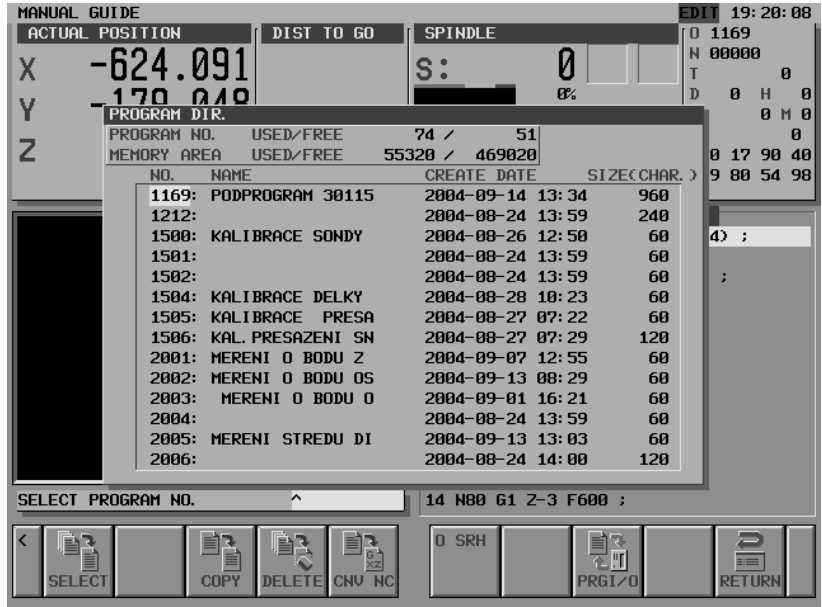

Handle-based guidance machining can also be performed on the same screen.

Screen example 5) Window for guidance machining

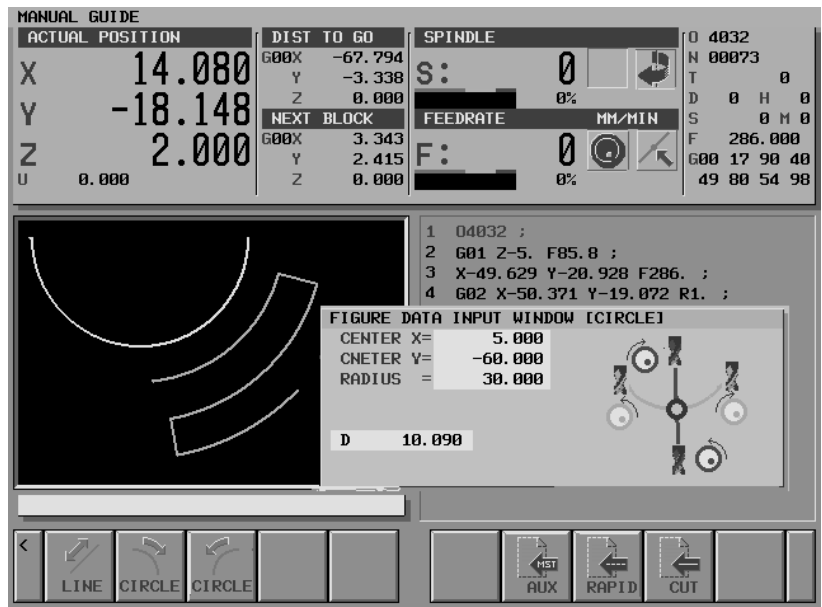

IV. HAND CNC (Series 20*i*)

1

OUTLINE OF HAND CNC (Series 20i)

The Series 20i CNC has been developed for general purpose milling machines and general-purpose lathes. These kind of general-purpose machine tools differ greatly from regular CNC machine tools. For this reason, CNC units for controlling these machine tools are provided with many exclusive functions. Generally a CNC unit developed exclusively for these kind of general-purpose machine tools is called a “hand CNC” to differentiate it from other CNC units.

The Series 20i has a machining guidance function that does not use NC statement programs as an exclusive function for general-purpose machine tools. This machining guidance function allows you to easily perform a variety of machining processes as if you were operating a general-purpose machine without any special knowledge of CNC; all you need to do is to set the minimum required data such as position data.

The machine tool builder can customize this function because it has been implemented using the macro executor.

If you install the optional guidance programming function, you can also make NC statement programs using menu selection. In addition to basic NC program statements, these menus are provided with pattern machining processes called “cycle machining.” For example, on the Series 20i-F, you can easily execute complex machining such as plane machining or pocket machining.

2 LIST OF SPECIFICATIONS

FANUC Series 20i-TB CNC for manual lathes
 FANUC Series 20i-FB CNC for manual milling machines

○ : Standard ☆ : Option
 ※ : Function included in another option
 — : Relevant function not available ▲ : Standard option
 ● : Standard function usable in machining guidance function
 Or, standard specification usable in macro executor
 ★ : Option usable in machining guidance
 Or, option usable in macro executor

Item	Specifications	Series 20i			
		TB		FB	
		Guidance Programming or NC Program editing			
		Without	With	Without	With

Controlled axis

Total Controlled axes	2 axes	○	○	—	—	
	4 axes (Machine controlled axes)	—	—	☆	☆	
Machine controlled axes	Controlled path	1 path	○	○	○	○
	Controlled axis	2 axes	○	○	—	—
		3 axes	—	—	○	○
	Simultaneously controlled axes	Simultaneous 2 axes	○	○	—	—
		Simultaneous 3 axes	—	—	○	○
	Controlled axes expansion (total)	Max. 4 axes	—	—	☆	☆
Axis control by PMC		—	—	☆	☆	
Axis name	Basic 3 axes are X, Y and Z, additional axis is optional from U, V, W, A, B, C.	—	—	○	○	
	Basic 2 axes are X, Z	○	○	—	—	
Control axis detach		—	—	☆	☆	
Chopping		—	—	☆	☆	
Least input increment	0.001mm, 0.001deg, 0.0001inch	○	○	○	○	
Increment system 1/10	*1 0.0001mm, 0.0001deg, 0.00001inch	—	—	★	☆	
Flexible feed gear	Optional DMR	○	○	○	○	
Fine Acc & Dec control		○	○	○	○	
HRV control		○	○	○	○	
High-speed HRV control	Servo HRV3 control	○	○	○	○	
Inch/metric conversion		☆	☆	☆	☆	
Interlock	All axes/each axis/each direction/block start/cutting block start	○	○	○	○	
Machine lock	All axes/each axis	○	○	○	○	
Emergency stop		○	○	○	○	

Note) The items marked with *1 to *5 have notes added. These notes are provided at the end of this table.

Item	Specifications	Series 20i			
		TB		FB	
		Guidance Programming or NC Program editing			
		Without	With	Without	With
Overtravel		○	○	○	○
Stored stroke check 1		○	○	○	○
Stroke limit external setting		—	—	○	○
Stored stroke check 2		—	—	☆	☆
Mirror image	Each axis	○	○	○	○
Follow-up		○	○	○	○
Servo off/mechanical handle feed		○	○	○	○
Chamfering on/off		○	○	—	—
Backlash compensation		○	○	○	○
Backlash compensation for each rapid traverse and cutting feed		○	○	○	○
Stored pitch error compensation		☆	☆	☆	☆
Unexpected disturbance torque detection function		☆	☆	☆	☆

Operation

Automatic operation (memory)		●	○	●	○
DNC operation	Reader/puncher interface is required	—	○	—	○
MDI operation		—	○	—	○
Program number search		—	○	—	○
Sequence number search		—	○	—	○
Program restart		—	—	—	☆
Manual intervention and return		—	○	—	○
Buffer register		○	○	○	○
Dry run		○	○	○	○
Single block		○	○	○	○
JOG feed		○	○	○	○
Manual reference position return		○	○	○	○
Reference position setting without DOG		○	○	○	○
Manual handle feed	1 unit/2 units/3 units	○	○	—	—
	1 unit/2 units/3 units/4 units	—	—	○	○
Manual handle feedrate	× 1, × 10, × m, × n m: 0 to 127, n: 0 to 1000	○	○	○	○
Manual handle interruption		☆	☆	☆	☆
Incremental feed	× 1, × 10, × 100, × 1000	○	○	○	○
Jog and handle simultaneous mode		○	○	○	○

Interpolation functions

Positioning	G00	●	○	●	○
Single direction positioning	G60	—	—	★	☆
Exact stop mode	G61	—	—	●	○
Exact stop	G09	—	—	●	○
Linear interpolation		●	○	●	○
Circular interpolation	Multi-quadrant is possible	●	○	●	○
Dwell	In seconds	●	○	●	○

Note) The items marked with *1 to *5 have notes added. These notes are provided at the end of this table.

Item	Specifications	Series 20i			
		TB		FB	
		Guidance Programming or NC Program editing			
		Without	With	Without	With
Helical interpolation	Circular interpolation plus max. 2 axes linear interpolation *4	—	—	★	☆
Threading, synchronous cutting	Position coder is necessary on the spindle	●	○	○	○
Multiple threading		●	○	—	—
Threading retract		★	☆	—	—
Continuous threading	*4	★	☆	—	—
Variable lead threading	*4	★	☆	—	—
Skip	G31	●	○	●	○
High-speed skip		—	—	★	☆
Torque limit skip		●	○	—	—
Reference position return	G28	●	○	●	○
Reference position return check	G27	●	○	●	○
2nd reference position return		●	○	●	○

Feed function

Rapid traverse rate	Max. 240m (1μm)	○	○	○	○
Rapid traverse override	F0, 25, 50, 100%	○	○	○	○
Feed per minute		○	○	○	○
Feed per revolution		○	○	—	—
Tangential speed constant control		○	○	○	○
Cutting feedrate clamp		○	○	○	○
Automatic acceleration/ deceleration	Rapid traverse: linear Cutting feed: exponential	○	○	○	○
Linear acceleration/deceleration after cutting feed interpolation		☆	☆	☆	☆
Bell-shaped acceleration/deceleration after cutting feed interpolation		☆	☆	☆	☆
Feedrate override	0 to 254%	○	○	○	○
Jog override	0 to 655.34%	○	○	○	○
Override cancel		○	○	○	○
Manual per revolution feed		○	○	—	—
The stop position setting with the manual feed		☆	☆	—	—
Advanced preview control		—	—	☆	☆
AI contour control		—	—	—	☆

Program input

Tape code	EIA RS244/ISO840 Automatic recognition	●	○	●	○
Label skip		●	○	●	○
Parity check	Horizontal and vertical parity	●	○	●	○
Control in/out		●	○	●	○
Optional block skip	1	●	○	●	○
Max. programmable dimension	±8 digit	○	○	○	○
Program number	O4 digit	●	○	●	○
Sequence number	N5 digit	●	○	●	○

Note) The items marked with *1 to *5 have notes added. These notes are provided at the end of this table.

Item	Specifications	Series 20i			
		TB		FB	
		Guidance Programming or NC Program editing			
		Without	With	Without	With
Absolute/incremental programming	Combined use in the same block	●	○	●	○
Decimal point programming/pocket calculator type decimal point programming		●	○	●	○
Input unit 10 time multiply		—	—	●	○
Diameter/radius programming (X axis)		●	○	—	—
Plane selection	G17, G18, G19	—	—	●	○
Rotary axis designation		—	—	●	○
Rotary axis roll-over		—	—	●	○
Coordinate system setting		●	○	●	○
Automatic coordinate system setting		○	○	○	○
Coordinate system shift		●	○	—	—
Direct input of coordinate system shift		●	○	—	—
Workpiece coordinate system	G52, G53, G54 to G59	—	—	●	○
Workpiece coordinate system preset	*4	—	—	★	☆
Manual absolute on and off		●	○	●	○
G code system A		●	○	—	—
G code system B/C		★	☆	—	—
Chamfering/corner R		★	☆	—	—
Optional chamfering/corner R	*4	—	—	★	☆
Programmable data input	G10	★	☆	★	☆
Sub program call	4 folds nested	●	○	●	○
Custom macro B		★	☆	★	☆
Interruption type custom macro		★	☆	—	—
Canned cycles		●	○	—	—
Multiple repetitive cycle	*5	—	☆	—	—
Multiple repetitive cycle II	Pocket profile *5	—	☆	—	—
Canned cycles for drilling		—	—	★	☆
Circular interpolation by R programming		●	○	●	○
Automatic corner override	*4	—	—	★	☆
Scaling	*4	—	—	★	☆
Coordinate system rotation	*4	—	—	★	☆
Programmable mirror image	*4	—	—	★	☆
Macro executor A	Max. 1.5 MB (Including machining guidance)	●	○	●	○
Additional custom memory 0.5 MB	In addition to macro executor A, Max. 2 MB is available.	☆	—	☆	—
Additional custom memory 1 MB	In addition to macro executor A, Max. 2.5 MB is available.	—	☆	—	☆
Additional custom memory 1.5 MB	In addition to macro executor A, Max. 3 MB is available.	☆	—	☆	—
Machining guidance function		○	○	○	○
Guidance programming function	*2	—	☆	—	☆
NC program editing function	*2	○	○	○	○

Note) The items marked with *1 to *5 have notes added. These notes are provided at the end of this table.

Item	Specifications	Series 20i			
		TB		FB	
		Guidance Programming or NC Program editing			
		Without	With	Without	With

Auxiliary/Spindle speed function

Auxiliary function	M8 digit	●	○	●	○
Auxiliary function lock		●	○	●	○
High speed M/S/T interface		●	○	●	○
Multiple command of auxiliary function	3	●	○	●	○
Spindle speed function	S5 digit, binary output	●	○	●	○
Spindle serial output	S5 digit, serial output	★	☆	★	☆
Spindle analog output	S5 digit, analog output	★	☆	★	☆
Constant surface speed control		●	○	—	—
Spindle override	0 to 254%	*	*	*	*
1st spindle orientation		☆	☆	☆	☆
1st spindle output switching function		☆	☆	☆	☆
Rigid tapping	*4	—	—	★	☆
Manual rigid tapping	*4	—	—	★	☆

Tool function/Tool compensation

Tool function	T7+1/T6+2 digits	●	○	—	—
	T8 digits	—	—	●	○
Tool offset pairs	±6 digits 16 pairs	●	○	—	—
	±6 digits 32 pairs	—	—	●	○
	±6 digits 64 pairs *4	—	—	★	☆
	±6 digits 200 pairs *4	—	—	★	☆
Tool offset memory B	Geometry/wear memory *4	—	—	★	☆
Tool offset memory C	Distinction between geometry and wear, or between cutter and tool length compensation. *4	—	—	★	☆
Tool length compensation		—	—	●	○
Tool offset		●	○	—	—
Cutter compensation C		—	—	●	○
Tool nose radius compensation		★	☆	—	—
Tool geometry/wear compensation		★	☆	—	—
Tool offset value counter input		●	○	—	—
Direct input of tool offset value measured		●	○	—	—

Editing operation

Part program storage length	10 m	●	○	●	○
	20 m	★	☆	★	☆
	40 m	★	☆	★	☆
	80 m	★	☆	★	☆
	160 m	★	☆	★	☆
	320 m	—	—	★	☆

Note) The items marked with *1 to *5 have notes added. These notes are provided at the end of this table.

Item	Specifications	Series 20i			
		TB		FB	
		Guidance Programming or NC Program editing			
		Without	With	Without	With
Number of registerable programs	63	●	○	●	○
	125	—	—	★	☆
	200	—	—	★	☆
Part program editing		—	○	—	○
Program protect		—	○	—	○
Background editing		—	☆	—	☆
Extended part program editing	Available in NC program editing function only	—	☆	—	☆
Playback		—	☆	—	☆

Setting and display

Status display		○	○	○	○
Clock function		○	○	○	○
Current position display		○	○	○	○
Program display	Program name 16 characters	—	○	—	○
Parameter setting and display		○	○	○	○
Self-diagnosis function		○	○	○	○
Alarm display		○	○	○	○
Alarm history display		○	○	○	○
Operation history display		○	○	○	○
Help function		○	○	○	○
Remote diagnostic	Machine remote diagnosis package+Ethernet (Function:Reading CNC/PMC status, etc.)	*	*	*	*
Run hour and parts count display		☆	☆	☆	☆
Actual cutting feedrate display		○	○	○	○
Display of spindle speed and T code at all screens		○	○	*	*
Directory display of floppy cassette		—	☆	—	☆
Directory display and punch for each group		—	○	—	○
Graphic function		○	○	○	○
Dynamic graphic display		—	☆	—	☆
Servo setting screen		○	○	○	○
Spindle setting screen	Only for serial interface	*	*	*	*
Servo waveform display		*	*	*	*
Display of hardware and software configuration		○	○	○	○
Periodic maintenance screen		○	○	○	○
Maintenance information screen		○	○	○	○
Software operator's panel		☆	☆	☆	☆
Software operator's panel general purpose switch		☆	☆	☆	☆
External touch panel interface	It is impossible to use with the Touch panel	—	—	☆	☆

Note) The items marked with *1 to *5 have notes added. These notes are provided at the end of this table.

Item	Specifications	Series 20i			
		TB		FB	
		Guidance Programming or NC Program editing			
		Without	With	Without	With
Multi-language display	English	○	○	○	○
	Japanese (Chinese character)	☆	☆	☆	☆
	German/French	☆	☆	☆	☆
	Italian	☆	☆	☆	☆
	Chinese	☆	☆	☆	☆
	Spanish	☆	☆	☆	☆
	Korean	☆	☆	☆	☆
Data protection key		○	○	○	○
Erase LCD screen display		○	○	○	○

Data input/output

Reader/puncher interface	Reader/puncher (Ch.1) interface	☆	☆	☆	☆
	Reader/puncher (Ch.2) interface	☆	☆	☆	☆
Remote buffer		—	—	—	☆
External I/O device control		☆	☆	☆	☆
Modem card control		○	○	○	○
External data input		☆	☆	☆	☆
External key input		○	○	○	○
External program input		—	○	—	○
External workpiece number search	15	—	○	—	○
Memory card input/output		—	○	—	○
Screen hard copy		○	○	○	○
Power Mate CNC manager		☆	☆	☆	☆

Interface function

Embedded Ethernet		☆	☆	☆	☆
Fast Ethernet	Fast Ethernet board is required.	☆	☆	☆	☆

Machining guidance function

Line/Circle cutting		○	●	○	●
Corner cutting		○	●	○	●
Pocketing	Circle, Square, Track	—	—	○	●
Pattern positioning	Circle, Square, Grid, Random	—	—	○	●
Hole machining	Drilling, Center, Tapping *3	○	●	☆	★
Side cutting	Circle, Square, Track	—	—	☆	★
Limit machining	Square limited area	—	—	☆	★
Polygonal limited cutting	Convex polygon with maximum 6 corner	—	—	☆	★
Rough machining	Maximum 28 points (only TB)	○	●	☆	★
Facing		—	—	☆	★
Threading		○	●	—	—
Grooving	Normal, Trapezoid	○	●	—	—
Tool compensation		—	—	☆	★
—X area cutting		☆	★	—	—

Note) The items marked with *1 to *5 have notes added. These notes are provided at the end of this table.

Item	Specifications	Series 20i			
		TB		FB	
		Guidance Programming or NC Program editing			
		Without	With	Without	With

Guidance programming function

Feed command	G00, G01, G02, G03	—	○	—	○
Workpiece coordinate system	G50 (TB), G55 TO G59 (FB)	—	○	—	○
Feed per minute/revolution	G98, G99	—	○	—	—
Constant surface speed control	G96, G97	—	○	—	—
Chamfering/Corner R		—	☆	—	—
Tool nose radius compensation	G40 to G42	—	☆	—	—
Cutter compensation	G40 to G42	—	—	—	○
Tool length compensation	G43, G44, G49	—	—	—	○
Plane selection	G17 to G19	—	—	—	○
Coordinate system rotation	G68, G69	—	—	—	☆
Threading	G32	—	○	—	—
Cycle	Thread cycle (G92)	—	○	—	—
	Pocketing	—	—	—	○
	Side cutting	—	—	—	○
	Facing	—	—	—	○
	Pattern positioning	—	—	—	○
	Hole machining	—	—	—	○
Inch/metric conversion	G20, G21	—	☆	—	☆
Contour form symbolic input	G01, G02, G03	—	—	—	☆

Others

Status output signal	NC ready, servo ready, automatic operation, automatic operation start lamp, feed hold, reset, NC alarm, distribution end, rewinding, inch input, cutting, inposition, thread cutting, tapping, etc.	○	○	○	○	
Setting and display unit	8.4" color LCD	○	○	○	○	
Control unit dimensions (depth)	Without option slots (depth 60mm)	○	○	○	○	
	Option 2 slots (depth 110mm)	—	—	☆	☆	
MDI unit	Separate MDI for 8.4" LCD (small size)	○	○	○	○	
PMC SYSTEM	PMC-SA1	▲	▲	▲	▲	
	PMC-SB7	▲	▲	▲	▲	
Machine interface (I/O Link) Max. DI/DO points: 1024/1024 points	I/O Unit-MODEL A	▲	▲	▲	▲	
	I/O Unit-MODEL B	▲	▲	▲	▲	
	Operator's panel I/O module	72 DI/56 DO	▲	▲	▲	▲
		48 DI/32 DO	▲	▲	▲	▲
	Connection panel I/O module	▲	▲	▲	▲	
Power magnetic control I/O module	▲	▲	▲	▲		
Manual pulse generator		☆	☆	☆	☆	
Connectable servo motor	FANUC AC servo motor α is series, β is series	○	○	○	○	
Connectable servo amplifier	FANUC AC servo amplifier α i series, β i series (SVM)	○	○	○	○	

Note) The items marked with *1 to *5 have notes added. These notes are provided at the end of this table.

Item	Specifications	Series 20i			
		TB		FB	
		Guidance Programming or NC Program editing			
		Without	With	Without	With
Separate position detector for full-closed control (for full-closed control)	Separate pulse coder/optical scale (2-phase pulse interface)	☆	☆	☆	☆
	Separate pulse coder/optical scale (Serial interface)	☆	☆	☆	☆
Connectable spindle motor	FANUC AC spindle motor α i series	○	○	○	○
Connectable spindle amplifier	FANUC servo amplifier α i series	☆	☆	☆	☆
	Analog interface	☆	☆	☆	☆
SERVO GUIDE		☆	☆	☆	☆
Input power supply	DC24V \pm 10%	○	○	○	○
Temperature around unit	At operating: 0°C to 58°C At non operating: -20°C to 60°C	○	○	○	○
Ambient relative humidity	Normally: less than 75% No dew, nor frost allowed Short term (within one month) less than 95% No dew, nor frost allowed	○	○	○	○
Vibration	At operating: less than 0.5G At non operating: less than 1G	○	○	○	○

Note) The items marked with *1 to *5 have notes added. These notes are provided at the end of this table.

NOTE

- The FANUC standard machining guidance function and guidance programming function do not support setting unit IS-C. This setting unit can be supported by remodeling by the machine tool manufacturer.
- Parameter settings allows you to enable or disable display of the NC program editing screen. There are two editing methods:
 - Editing by guidance programming (option)
 - Editing by NC language
The following four methods of use are possible by setting options and parameters.

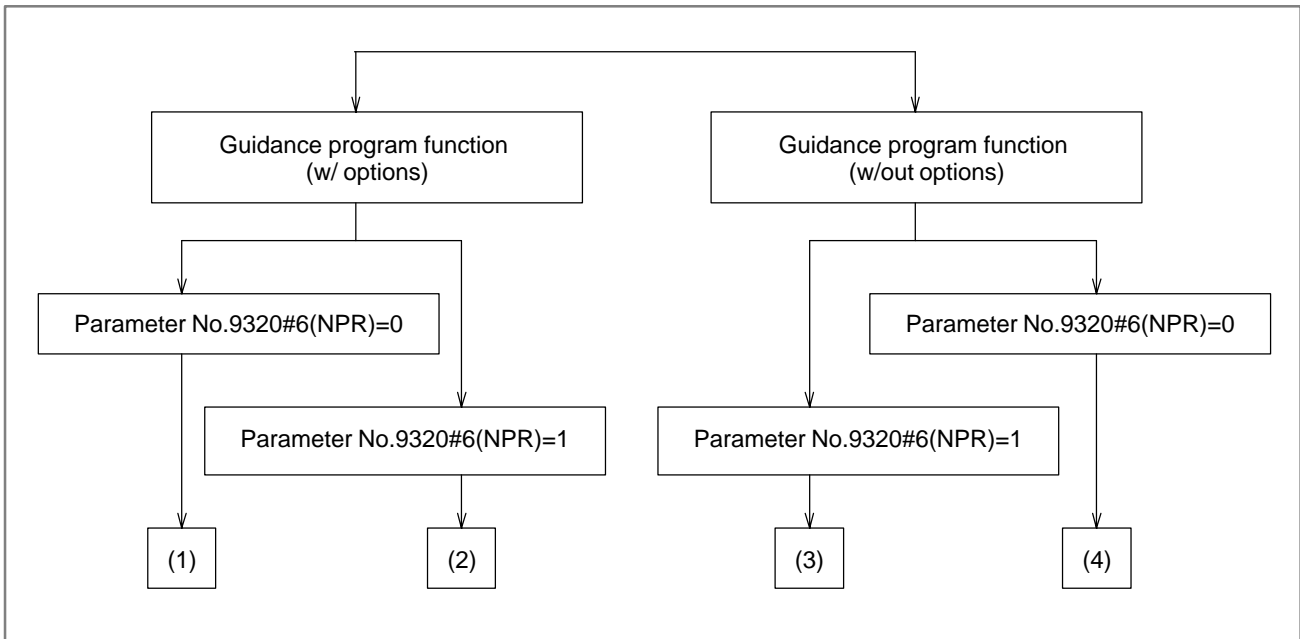

(1) “Guidance programming function” only

Exactly the same method of use as the “guidance programming function” on the Series 20–FB/TB is possible by setting parameter No.9320#6(NPR) to “0” when the “guidance programming function” (option) is not added on.

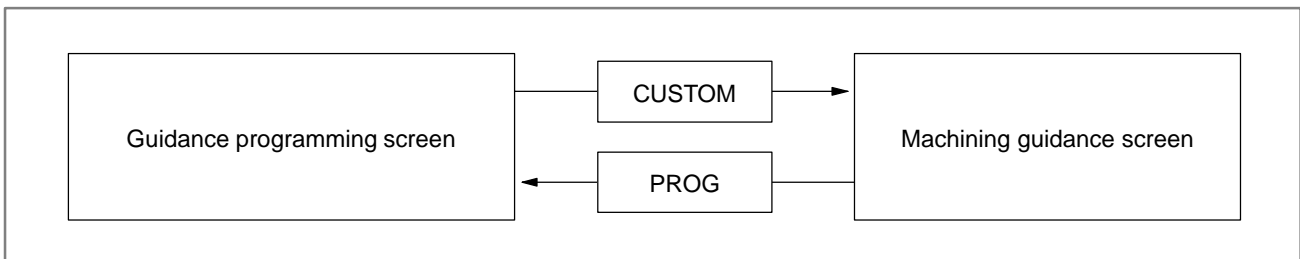

In this case, the CNC language screen can be displayed by pressing the [NC language] soft key, and programs can be edited or made in this screen. However, screen functions are limited and some functions such as the extended part program editing function cannot be used.

(2) “Guidance programming function” + “NC program editing function”

You can use both the same NC program editing screen and the guidance programming function as other CNCs (e.g. Series 21i) by setting parameter No.9320#6(NPR) to “0” when the “guidance programming function” (option) is not added on.

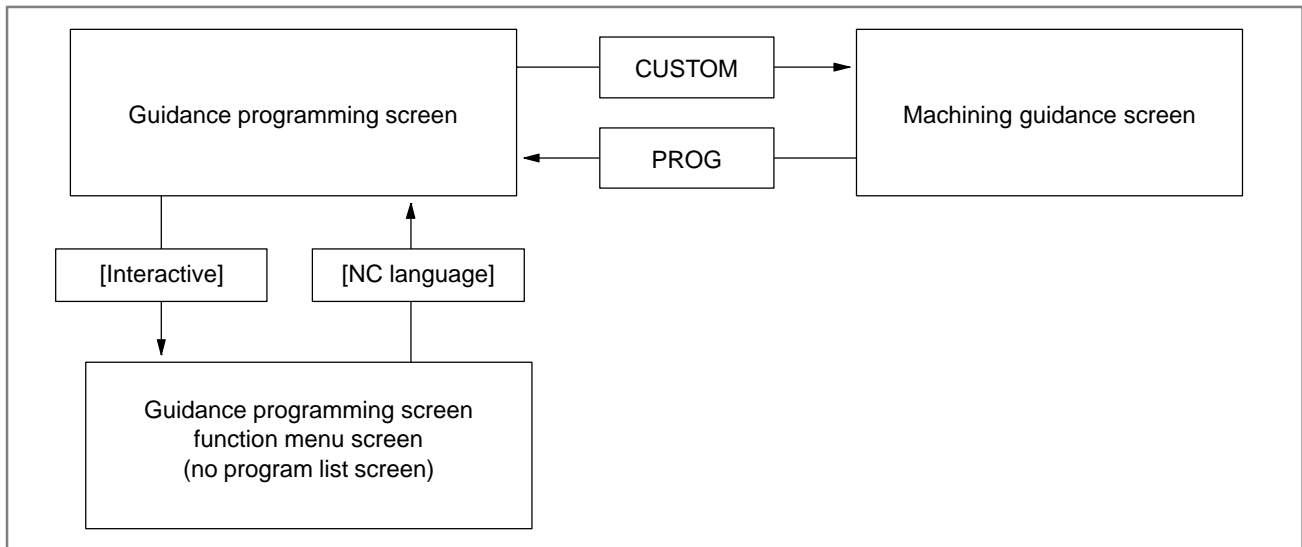

In this case, the program list screen in the guidance programming function cannot be used. However, the extended part program editing function can be used by adding on options.

Also, NC program conversion can be selected for machining programs that have been made using the guidance programming function by using [NC conversion] displayed in the function menu screen of the guidance programming screen. In this case, the program currently displayed at that time is converted to an NC program.

(3) “NC program editing function” only

You can display the same NC program editing screen as other CNCs (e.g. Series 21i) and make and edit NC programs in that screen by setting parameter No.9320#6(NPR) to “0” when the “guidance programming function” (option) is not added on.

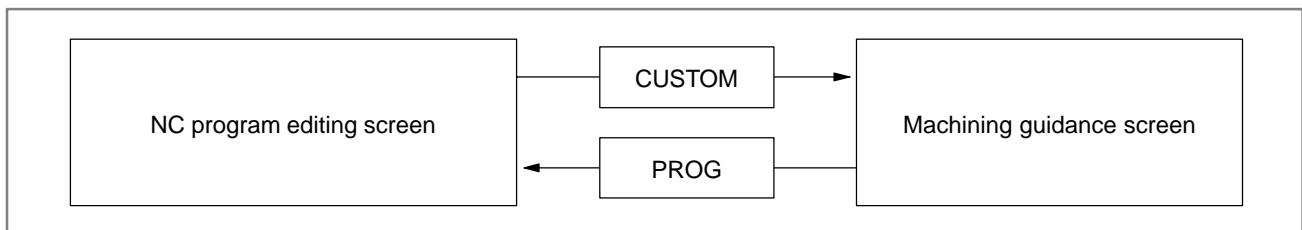

(4) W/out CNC program editing function

When the “guidance programming function” (optional) is not added on, and parameter No.9320#6(NPR) is set to “0”, CNC programs cannot be edited or made.

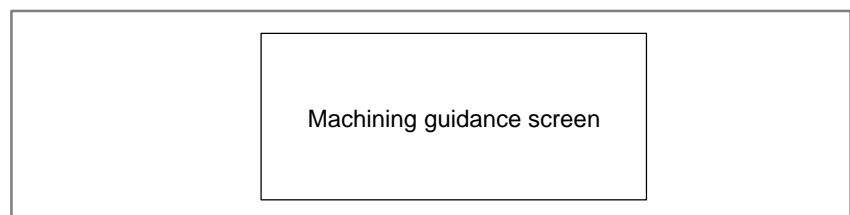

NOTE

- 3 In drilling using the machining guidance function for a lathe, only drilling can be used.
- 4 The FANUC standard machining guidance function and guidance programming function do not support these functions. The machining guidance function can be supported by remodeling by the machine tool manufacturer.
- 5 This function cannot be used on the machining guidance function and macro executor.

3

MACHINING GUIDANCE FUNCTION

Series 20i-FB Machining Guidance Function

- In addition to manual operation, this function allows you to easily machine complex shapes such as inclined straight lines or arc by operation like that on the control panel of a general-purpose milling machine.
- This function is provided as a FANUC standard function. However, the machine tool builder can customize the function because it has been prepared in the form of a macro program using the macro executor.
- During machining in manual operation, select the machining method from the machining guidance menu, enter the required data and machine the desired profile.
- Position data can be input by numerical value keys or moving the tool by the handle and pressing buttons.
- The following machining menus are provided as basic functions:
 - 1) Linear machining
 - 2) Circular machining
 - 3) Corner machining
 - 4) Pocket machining (circle, square, track)
 - 5) Pattern positioning (circle, square, grid, arbitrary)
- The following machining menus are optional:
 - 1) Drilling (drill, center, tap)
 - 2) Side machining (circle, square, track)
 - 3) Limit machining (square profile limit)
 - 4) Polygon limit machining (polygons up to convex hexagons)
 - 5) Roughing
 - 6) Plane machining
 - 7) Tool offset function
- For details of the machining guidance function, refer to the “Series 20i-FA/20i-FB Machining Guidance Function Operator’s Manual (B-62174E-1).”

Screen example 1) Linear machining

LINE CUTTING (XY)

X	0 . 0 0 0				
Y	0 . 0 0 0				
Z	0 . 0 0 0				
D	- 5 . 0 0 0				
DX	- 7 . 0 7 1				
DY	- 7 . 0 7 1				

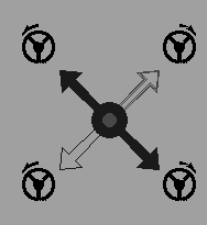

X1	10. 000	X2	0. 000	A	
Y1	20. 000	Y2	30. 000	φ	10. 000

GUIDANCE MACHINING
→MACHIN, ⇨APPROACH

POSIT.

Screen example 2) Tapping

HOLE MACHINING (TAP)

X	0 . 0 0 0				
Y	0 . 0 0 0				
Z	0 . 0 0 0				

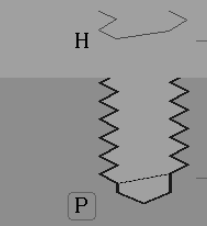

Z	50. 000	P	2	X	0. 000
R	20. 000	H	0	Y	0. 000
		F	200		

SELECT 4 HOLES OR PATTERN, OR
EXEC. BY*INPUT END Z:DEPTH

CONT. PATERN POSIT.

Screen example 3) Polygon limit machining

POLYGON LIMIT CUTTING (NO OUTER) (XY)

X	0 . 0 0 0				
Y	0 . 0 0 0				
Z	0 . 0 0 0				

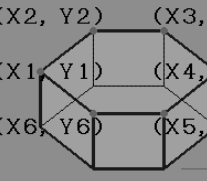

		X2	Y2	X3	Y3
	Z	X1	Y1		

φ

MOVE TO START POINT → *INPUT END
φ: TOOL DIA.

LINE CIRCLE NEXT INNER POSIT.

**Series 20i-TB Machining
Guidance Function**

- In addition to manual operation, this function allows you to easily machine complex shapes such as inclined straight lines or arc by operation like that on the control panel of a general-purpose milling machine.
- This function is provided as a FANUC standard function. However, the machine tool builder can customize the function because it has been prepared in the form of a macro program using the macro executor.
- During machining in manual operation, select the machining method from the machining guidance menu, enter the required data and machine the desired profile.
- Position data can be input by numerical value keys or moving the tool by the handle and pressing buttons.
- The following machining menus are provided as basic functions:
 - 1) Linear machining
 - 2) Circular machining
 - 3) Corner machining
 - 4) Drilling (drill)
 - 5) Roughing (max. 28 points)
 - 6) Roughing
 - 7) Groove cutting (regular groove, trapezoidal groove)
- The following machining menu is optional:
 - 1) XW/ X minus area switching function
- For details of the machining guidance function, refer to the “Series 20i-TA/TB Machining Guidance Function Operator’s Manual (B-62204E-1).”

Screen example 1) Circular machining

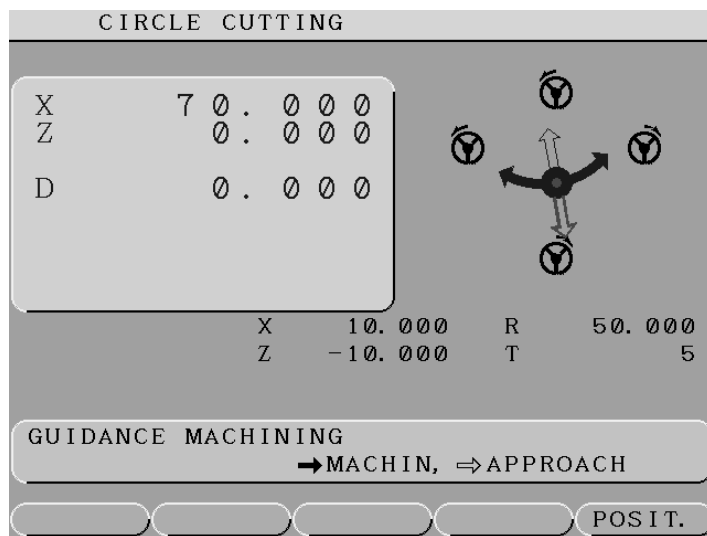

Screen example 2) Thread cutting

THREADING (OUTER) (BOTH)

X	0 . 0 0 0								
Z	0 . 0 0 0								

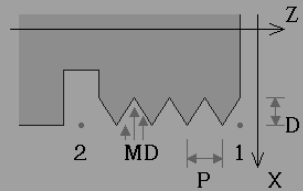

U	0								
H	1	D	1. 000						
C	0. 200	X1	60. 000	V	0. 200				
K	0	Z1	0. 000	B	1				
P	1. 000	X2	60. 000	A	60. 000				
MD	3	Z2	-10. 000	T	1				

AFTER SETTING DATA, *INPUT END
U: OUT=0 IN=1

POSIT.

Screen example 3) Groove cutting

GROOVING (OUTER)

X	0 . 0 0 0								
Z	0 . 0 0 0								

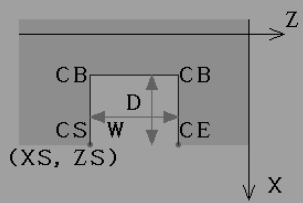

U	0								
W	10. 000								
D	5. 000								
XS	40. 000	CS	0. 100	P	2. 000				
ZS	40. 000	CE	0. 100	Q					
F	100. 000	CB		T	10				

AFTER SETTING DATA, *INPUT END
U: OUT=0 IN=1

CORN. R
POSIT.

4

GUIDANCE PROGRAMMING FUNCTION

- This function allows you to easily create or edit NC statement machining programs by means of menu selection. This function is optional on the Series 20i as it is a hand CNC developed for general-purpose machine-tools that do not use NC statement machining programs.
- This function is supplied as a FANUC standard function. Its contents cannot be modified.
- The following menus are provided for the Series 20i-F:
 - 1) Feed instruction (G00, G01, G02, G03)
 - 2) Coordinate system (G55 to G59)
 - 3) Cutter compensation (G40 to G42)
 - 4) Tool length compensation (G43, G44, G49)
 - 5) Plane selection (G17 to G19)
 - 6) Coordinate system rotation (G68, G69: optional NC function required)
 - 7) Inch/metric conversion (G20, G21: optional NC function required)
 - 8) Plane machining (square plane)
 - 9) Drilling (drill, center, tap, boring)
 - 10) Drilling pattern position (circle periphery, arc, square, grid, arbitrary)
 - 11) Side machining (outer side of circle, inner side of circle, outer side of square, outer side of track)
 - 12) Pocket machining (circle, square, track)
- The following menus are provided on the Series 20i-T:
 - 1) Feed instruction (G00, G01, G02, G03)
 - 2) Coordinate system (G50)
 - 3) Constant surface speed control (G96, G97)
 - 4) MAIW/N feed per revolution (G98, G99)
 - 5) Chamfering/Corner R (optional NC function required)
 - 6) Tool nose radius compensation (G40, G42: optional NC function required)
 - 7) Thread cutting (G32, G92)
 - 8) Inch/metric conversion (G20, G21: optional NC function required)

Screen example 1) Feed instruction (Series 20i-F)

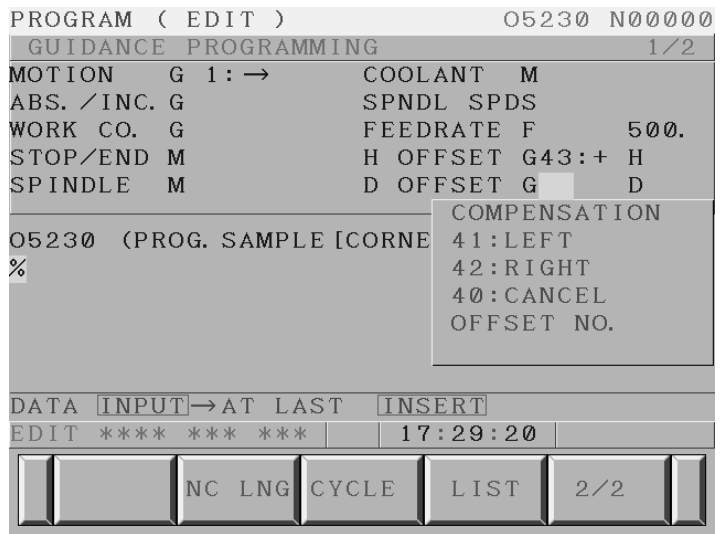

Screen example 2) Drilling pattern position (Series 20i-F)

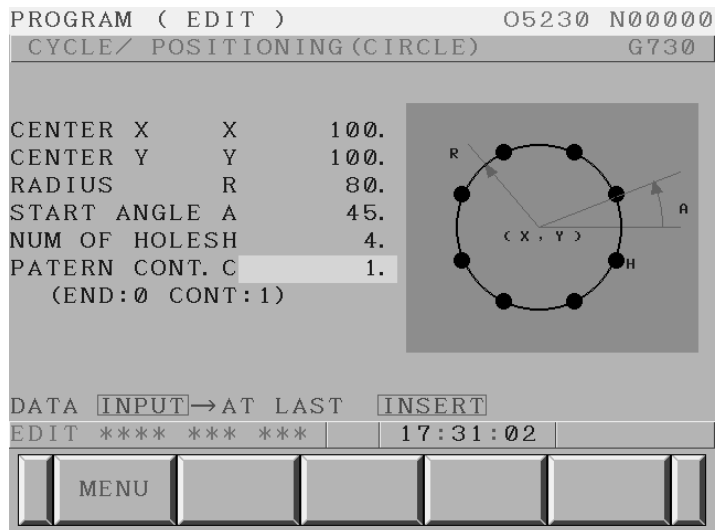

Screen example 3) Pocket machining (track) data input screen (Series 20i-F)

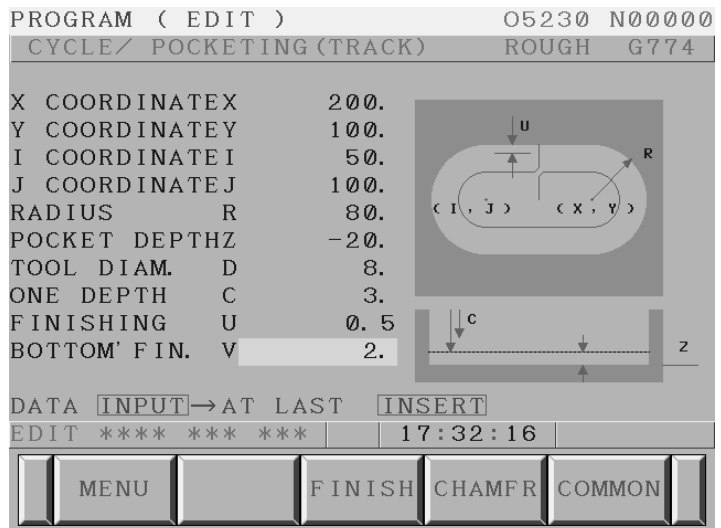

Screen example 4) Screen example 4) Program list screen (Series 20i-T)

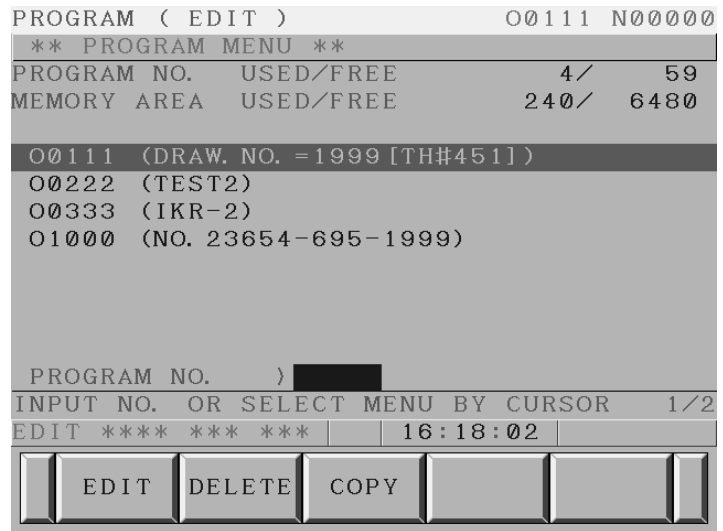

Screen example 5) Thread cutting menu (Series 20i-T)

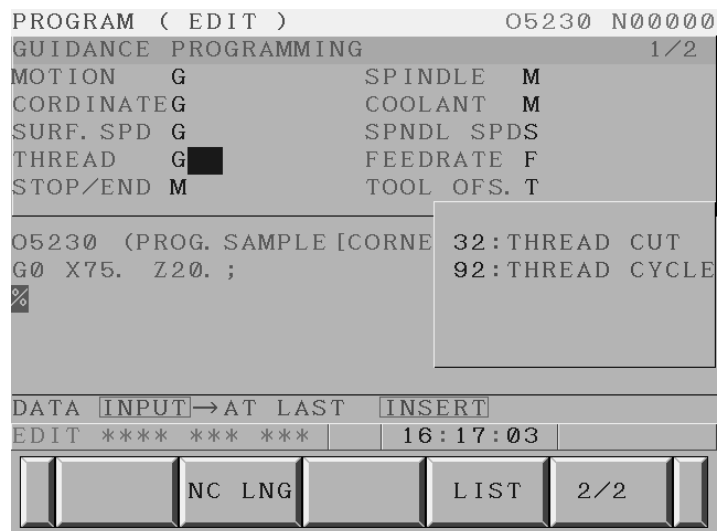

Screen example 6) Corner radius data input screen (Series 20i-T)

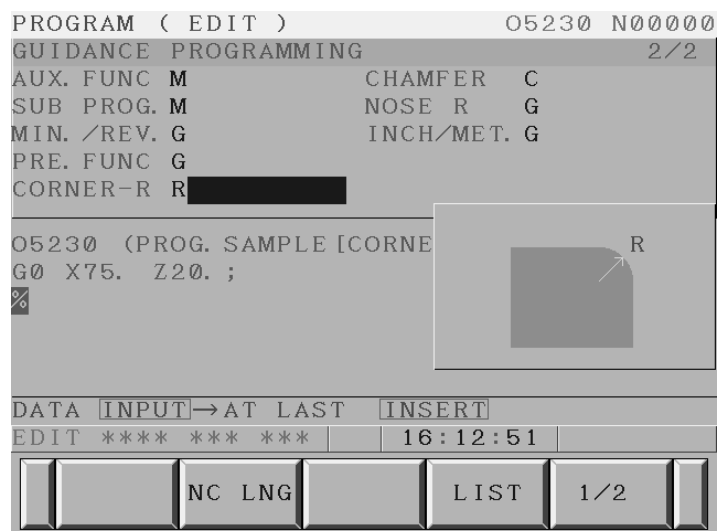

5

NC FUNCTIONS OF 20*i*



This chapter describes the NC functions specific to the Series 20*i*. For an explanation of the other NC functions, see Part II.

5.1 MANUAL HANDLE FEED

This function allows you to rotate up to three manual pulse (T series) or up to four manual pulse generators (F series) and move the tool over the distance corresponding to the rotation. The function also allows you to set a magnification for each manual pulse generator.

5.2 FUNCTION KEYS AND SOFT KEYS

The function selection soft keys are intended to select screens. Their functions are equivalent to those of the function keys. For example, pressing function selection soft key [POS] selects the same screen that is selected using the  function key.







The function selection soft keys are displayed when bit 0 of parameter No. 3101 (FSK) is 0. They are not displayed when the bit is 1.

The following function selection keys are available.

[POS] [PRGRM] [SETING] [SYSTEM] [(CHAP)]

[MSG] [] [CUSTOM] [] [(CHAP)]

The following table lists the function selection soft keys and the corresponding function keys.

Function selection soft key	Corresponding function key
[POS]	
[PRGRM]	
[SETING]	
[SYSTEM]	
[MSG]	
[CUSTOM]	

Pressing soft key [(CHAP)] displays the chapter selection soft keys.

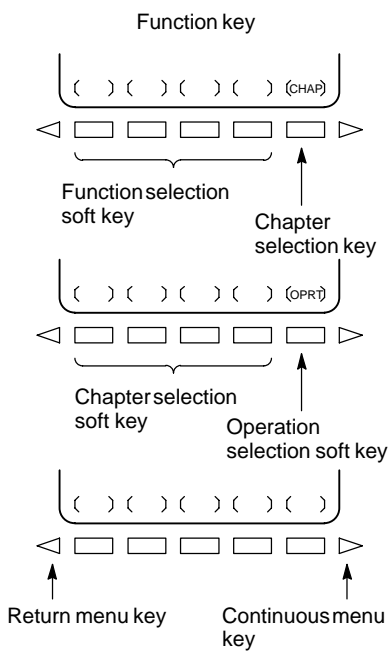

1 Pressing one of the chapter selection soft keys displays the corresponding screen.

If a desired chapter soft key does not appear, press the continuous menu key.

In some cases, several other chapters can be selected in a chapter.

2 When the desired chapter screen appears, press the operation selection key to display the items you want to operate.

3 To return to the chapter selection soft key display, press the return menu key.

If bit 0 of parameter No. 3101 (FSK) is 0, pressing the return menu key displays the function selection soft keys again.

5.3 SPECIAL KEY OPERATIONS

Special key operations can be performed if standard operations of alarm cancellation and memory clearing are disabled because the standard MDI keys are not provided, or for some other reason.

5.3.1 Clearing All Memory Data

You can perform an operation for clearing all memory data using numeric keys as if you were using the key combination of [RESET] and [DELETE].

Procedure

Turn on the power while holding down the numeric keys [7] and [9]. All memory data is cleared in the same way as when you turn on the power while holding down the [RESET] and [DELETE] keys.

5.3.2 Canceling Alarm 101

You can cancel alarm 101 by following the procedure described here if [RESET] and [PROG] cannot be used to cancel the alarm because the standard MDI keys are not provided, or for some other reason.

Procedure

- (1) Turn on the power while holding down the [-] and [.] keys.
(The IPL screen appears.)
- (2) Press [1] (MEMORY CLEAR) and then [INPUT].
(The menu screen for MEMORY CLEAR appears.)
- (3) Press [7] (PROGRAM (P/S ALARM101) and then [INPUT].

APPENDIX

A

RANGE OF COMMAND VALUE



A.1 T SERIES

Linear axis

- In case of metric input,
feed screw is metric

	Increment system	
	IS-B	IS-C
Least input increment	0.001 mm	0.0001 mm
Least command increment	X : 0.0005 mm (diameter) Y : 0.001 mm (radius)	X : 0.00005 mm (diameter) Y : 0.0001 mm (radius)
Max. programmable dimension	±99999.999 mm	±9999.9999 mm
Max. rapid traverse *1	240000 mm/min	100000 mm/min
Feedrate range *1	Feed per minute : 1 to 240000 mm/min Feed per revolution 0.0001 to 500.0000 mm/rev	Feed per minute : 1 to 100000 mm/min Feed per revolution 0.0001 to 500.0000 mm/rev
Incremental feed	0.001, 0.01, 0.1, 1mm/step	0.0001, 0.001, 0.01, 0.1 mm/step
Tool compensation	0 to ±999.999 mm	0 to ±999.9999 mm
Backlash compensation	0 to ±0.255 mm	0 to ±0.255 mm
Dwell time	0 to 99999.999 sec	0 to 9999.9999 sec

- In case of inch input,
feed screw is metric

	Increment system	
	IS-B	IS-C
Least input increment	0.0001 inch	0.00001 inch
Least command increment	X : 0.0005 inch (diameter) Y : 0.001 inch (radius)	X : 0.00005 inch (diameter) Y : 0.0001 inch (radius)
Max. programmable dimension	±9999.9999 inch	±393.70078 inch
Max. rapid traverse *1	240000 mm/min	100000 mm/min
Feedrate range *1	Feed per minute : 0.01 to 9600 inch/min Feed per revolution 0.000001 to 9.999999 inch/rev	Feed per minute : 0.01 to 4000 inch/min Feed per revolution 0.000001 to 9.999999 inch/rev
Incremental feed	0.0001, 0.001, 0.01, 0.1 inch/step	0.00001, 0.0001, 0.001, 0.01 inch/step
Tool compensation	0 to ±99.9999 inch	0 to ±99.99999 inch
Backlash compensation	0 to ±0.255 mm	0 to ±0.255 mm
Dwell time	0 to 99999.999 sec	0 to 9999.9999 sec

● In case of inch input,
feed screw is inch

	Increment system	
	IS-B	IS-C
Least input increment	0.0001 inch	0.00001 inch
Least command increment	X : 0.00005 inch (diameter) Y : 0.0001 inch (radius)	X : 0.000005 inch (diameter) Y : 0.00001 inch (radius)
Max. programmable dimension	±9999.9999 inch	±999.99999 inch
Max. rapid traverse *1	9600 inch/min	4000 inch/min
Feedrate range *1	Feed per minute : 0.01 to 9600 inch/min Feed per revolution 0.000001 to 9.999999 inch/rev	Feed per minute : 0.01 to 4000 inch/min Feed per revolution 0.000001 to 9.999999 inch/rev
Incremental feed	0.0001, 0.001, 0.01, 0.1 inch/step	0.00001, 0.0001, 0.001, 0.01 inch/step
Tool compensation	0 to ±99.9999 inch	0 to ±99.9999 inch
Backlash compensation	0 to ±0.0255 inch	0 to ±0.0255 inch
Dwell time	0 to 99999.999 sec	0 to 9999.9999 sec

● In case of metric input,
feed screw is inch

	Increment system	
	IS-B	IS-C
Least input increment	0.001 mm	0.0001 mm
Least command increment	X : 0.00005 inch (diameter) Y : 0.0001 inch (radius)	X : 0.000005 inch (diameter) Y : 0.00001 inch (radius)
Max. programmable dimension	±99999.999 mm	±9999.9999 mm
Max. rapid traverse *1	9600 inch/min	960 inch/min
Feedrate range *1	Feed per minute : 1 to 240000 mm/min Feed per revolution 0.0001 to 500.0000 mm/rev	Feed per minute : 1 to 100000 mm/min Feed per revolution 0.0001 to 500.0000 mm/rev
Incremental feed	0.001, 0.01, 0.1, 1mm/step	0.0001, 0.001, 0.01, 0.1 mm/step
Tool compensation	0 to ±999.999 mm	0 to ±999.9999 mm
Backlash compensation	0 to ±0.0255 inch	0 to ±0.0255 inch
Dwell time	0 to 99999.999 sec	0 to 9999.9999 sec

Rotation axis

	Increment system	
	IS-B	IS-C
Least input increment	0.001 deg	0.0001 deg
Least command increment	0.001 deg	0.0001 deg
Max. programmable dimension	±99999.999 deg	±9999.9999 deg
Max. rapid traverse *1	240000 deg/min	100000 deg/min
Feedrate range *1	1 to 240000 deg/min	1 to 100000 deg/min
Incremental feed	0.001, 0.01, 0.1, 1deg/step	0.0001, 0.001, 0.01, 0.1 deg/step
Backlash compensation	0 to ±0.255 deg	0 to ±0.255 deg

NOTE

*1 The feedrate range shown above are limitations depending on CNC interpolation capacity.
As a whole system, limitations depending on servo system must also be considered.

A.2 M SERIES

Linear axis

- In case of metric input,
feed screw is metric

	Increment system		
	IS-A	IS-B	IS-C
Least input increment	0.01 mm	0.001 mm	0.0001 mm
Least command increment	0.01 mm	0.001 mm	0.0001 mm
Max. programmable dimension	±999999.99 mm	±99999.999 mm	±9999.9999 mm
Max. rapid traverse *1	240000 mm/min	240000 mm/min	100000 mm/min
Feedrate range *1	1 to 240000 mm/min	1 to 240000 mm/min	1 to 100000 mm/min
Incremental feed	0.01, 0.1, 1, 10 mm/step	0.001, 0.01, 0.1, 1 mm/step	0.0001, 0.001, 0.01, 0.1 mm/step
Tool compensation	0 to ±999.99 mm	0 to ±999.999 mm	0 to ±999.9999 mm
Dwell time	0 to 99999.999 sec	0 to 99999.999 sec	0 to 9999.9999 sec

- In case of inch input,
feed screw is metric

	Increment system		
	IS-A	IS-B	IS-C
Least input increment	0.001 inch	0.0001 inch	0.00001 inch
Least command increment	0.01 inch	0.001 inch	0.0001 inch
Max. programmable dimension	±99999.999 inch	±9999.9999 inch	±393.70078 inch
Max. rapid traverse *1	240000 mm/min	240000 mm/min	100000 mm/min
Feedrate range *1	0.01 to 9600 inch/min	0.01 to 9600 inch/min	0.01 to 4000 inch/min
Incremental feed	0.001, 0.01, 0.1, 1 inch/step	0.0001, 0.001, 0.01, 0.1 inch/step	0.00001, 0.0001, 0.001, 0.01 inch/step
Tool compensation	0 to ±99.999 inch	0 to ±99.9999 inch	0 to ±99.99999 inch
Dwell time	0 to 99999.999 sec	0 to 99999.999 sec	0 to 9999.9999 sec

● In case of inch input,
feed screw is inch

	Increment system		
	IS-A	IS-B	IS-C
Least input increment	0.001 inch	0.0001 inch	0.00001 inch
Least command increment	0.001 inch	0.0001 inch	0.00001 inch
Max. programmable dimension	±99999.999 inch	±9999.9999 inch	±999.99999 inch
Max. rapid traverse *1	9600 inch/min	9600 inch/min	4000 inch/min
Feedrate range *1	0.01 to 9600 inch/min	0.01 to 9600 inch/min	0.01 to 4000 inch/min
Incremental feed	0.001, 0.01, 0.1, 1 inch/step	0.0001, 0.001, 0.01, 0.1 inch/step	0.00001, 0.0001, 0.001, 0.01 inch/step
Tool compensation	0 to ±99.999 inch	0 to ±99.9999 inch	0 to ±99.9999 inch
Dwell time	0 to 99999.999 sec	0 to 99999.999 sec	0 to 9999.9999 sec

● In case of metric input,
feed screw is inch

	Increment system		
	IS-A	IS-B	IS-C
Least input increment	0.01 mm	0.001 mm	0.0001 mm
Least command increment	0.001 inch	0.0001 inch	0.00001 inch
Max. programmable dimension	±999999.99 mm	±99999.999 mm	±9999.9999 mm
Max. rapid traverse *1	9600 inch/min	9600 inch/min	4000 inch/min
Feedrate range *1	1 to 240000 mm/min	1 to 240000 mm/min	1 to 100000 mm/min
Incremental feed	0.01, 0.1, 1, 10 mm/step	0.001, 0.01, 0.1, 1mm/step	0.0001, 0.001, 0.01, 0.1 mm/step
Tool compensation	0 to ±999.99 mm	0 to ±999.999 mm	0 to ±999.9999 mm
Dwell time	0 to 99999.999 sec	0 to 99999.999 sec	0 to 9999.9999 sec

Rotation axis

	Increment system	
	IS-B	IS-C
Least input increment	0.001 deg	0.0001 deg
Least command increment	0.001 deg	0.0001 deg
Max. programmable dimension	±99999.999 deg	±9999.9999 deg
Max. rapid traverse *1	240000 deg/min	100000 deg/min
Feedrate range *1	1 to 240000 deg/min	1 to 100000 deg/min
Incremental feed	0.001, 0.01, 0.1, 1 deg/step	0.0001, 0.001, 0.01, 0.1 deg/step

NOTE

*1 The feedrate range shown above are limitations depending on CNC interpolation capacity.

As a whole system, limitations depending on servo system must also be considered.

B FUNCTIONS AND TAPE FORMAT LIST



**B.1
T SERIES**

Some functions cannot be added as options depending on the model.
In the tables below, IP _: presents a combination of arbitrary axis
addresses using X and Z.

x = 1st basic axis (X usually)

z = 2nd basic axis (Z usually)

(1/5)

Functions	Illustration	Tape format
Positioning (G00)		G00 IP_;
Linear interpolation (G01)		G01 IP_ F_;
Circular interpolation (G02, G03)		G17 { G02 } X_ Y_ { R_ } F_ ; { G03 } { I_ J_ } G18 { G02 } X_ Z_ { R_ } F_ ; { G03 } { I_ K_ } G19 { G02 } Y_ Z_ { R_ } F_ ; { G03 } { J_ K_ }
Dwell (G04)		G04 { X_ } ; { P_ }
Cylindrical interpolation (G07.1) (G107)		G07.1 IP_R_ ; Cylindrical interpolation mode G07.1 IP0 ; Cylindrical interpolation mode cancel R: Radius of cylinder
Polar coordinate interpolation (G12.1, G13.1) (G112, G113)		G12.1 ; Polar coordinate interpolation mode G13.1 ; Polar coordinate interpolation mode cancel
Change of offset value by program (G10)		Tool geometry offset value G10 P_ X(U)_ Y(V)_ Z(W)_ R(C)_ Q_ ; P=1000+Geometry offset number Tool wear offset value G10 P_ X(U)_ Y(V)_ Z(W)_ R(C)_ Q_ ; P=Wear offset number

(2/5)

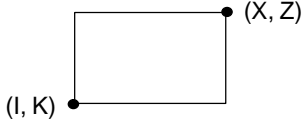
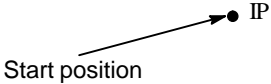
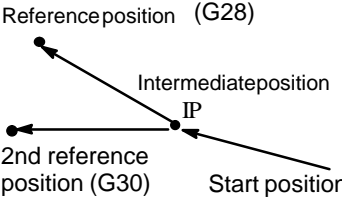
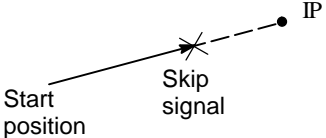
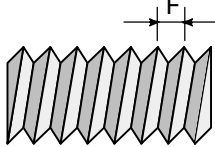
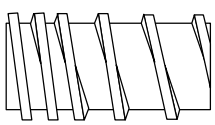
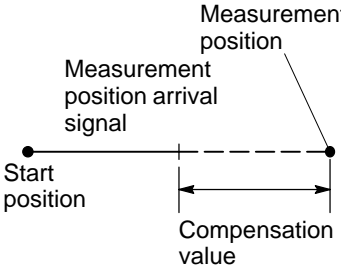
Functions	Illustration	Tape format
Plane selection (G17, G18, G19)		G17 ; G18 ; G19 ;
Inch/metric conversion (G20, G21)		Inch input : G20 Metric input : G21
Stored stroke check 2, 3 (G22, G23)		G22X_Z_I_K_ ; G23 ;
Spindle speed fluctuation detection (G25, G26)		G25 ; G26 P_Q_R_ ;
Reference position return check (G27)		G27 IP_ ;
Reference position return (G28) 2nd reference position re- turn (G30)		G28 IP_ ; G30 IP_ ;
Skip function (G31)		G31 IP_F_ ;
Thread cutting (G32)		Equal lead thread cutting G32 IP_F_ ;
Variable-lead threading		G34 IP_F_K_ ;
Automatic tool compensation (G36, G37)		G36 X xa ; G37 Z za ;

(3/5)

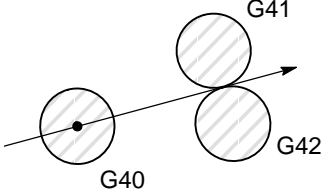
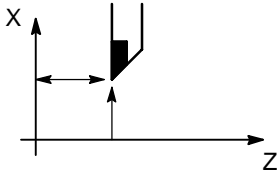
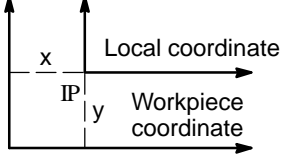
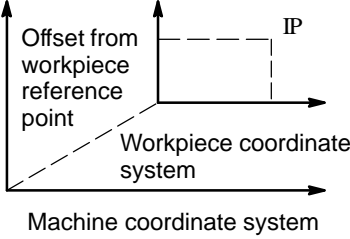
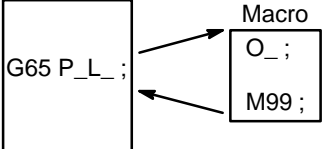
Functions	Illustration	Tape format
Tool nose radius compensation (G40, G41, G42)		$\left. \begin{matrix} G41 \\ G42 \end{matrix} \right\} IP_;$ G40 : Cancel
Coordinate system setting Spindle speed setting (G50)		G50 IP_ Coordinate system setting G50 S_ Maximum spindle speed setting
Polygon turning (G50.2, G51.2) (G250, G251)		G51.2 (G251) P_Q_ P,Q : Rotation ratio of spindle and rotary axis G50.2 (G250) ; Cancel
Workpiece coordinate system preset (G50.3)		G50.3 IP 0 ;
Local coordinate system setting (G52)		G52 IP _ ;
Machine coordinate system selection (G53)		G53 IP _ ;
Workpiece coordinate system selection (G54 to G59)		$\left. \begin{matrix} G54 \\ \vdots \\ G59 \end{matrix} \right\} IP_;$
Custom macro (G65, G66, G67)		One-shot call G65 P_L <argument> ; P : Program number L : Repetition count Modal call G66 P_L <argument> ; G67 ; Cancel

(4/5)

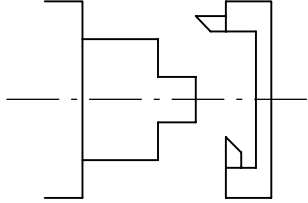
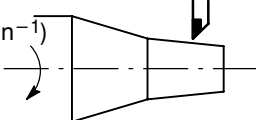
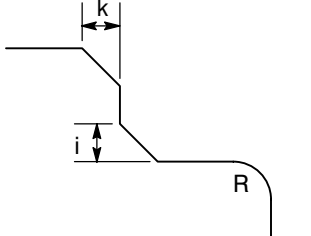
Functions	Illustration	Tape format
Mirror image for double turret (G68, G69)		G68 ; Mirror image for double turret on G69 ; Mirror image cancel
Canned cycle (G71 to G76) (G90, G92, G94)	Refer to II.13. FUNCTIONS TO SIMPLIFY PROGRAMMING	<p>N_ G70 P_ Q_ ; G71 U_ R_ ; G71 P_ Q_ U_ W_ F_ S_ T_ ; G72 W_ R_ ; G72 P_ Q_ U_ W_ F_ S_ T_ ; G73 U_ W_ R_ ; G73 P_ Q_ U_ W_ F_ S_ T_ ; G74 R_ ; G74 X(u)_ Z(w)_ P_ Q_ R_ F_ ; G75 R_ ; G75 X(u)_ Z(w)_ P_ Q_ R_ F_ ; G76 P_ Q_ R_ ; G76 X(u)_ Z(w)_ P_ Q_ R_ F_ ;</p> <p>{ G90 } { G92 } X_ Z_ R_ F_ ; { G94 }</p>
Canned cycle for drilling (G80 to G89)	See Chapter 13, "Functions to Simplify Programming" in Part II.	G80 ; Cancel G83 X(U)_C(H)_Z(W)_R_Q_P_F_M_K_ ; G84 X(U)_C(H)_Z(W)_R_P_F_M_K_ ; G85 X(U)_C(H)_Z(W)_R_P_F_M_K_ ; G87 Z(W)_C(H)_X(U)_R_Q_P_F_M_K_ ; G88 Z(W)_C(H)_X(U)_R_P_F_M_K_ ; G89 Z(W)_C(H)_X(U)_R_P_F_M_K_ ;
Constant surface speed control (G96/G97)	m/min or feet/min N (min ⁻¹) 	G96 S_ ; G97 ; Cancel
Feed per minute (G98) Feed per revolution (G99)	mm/min inch/min mm/rev inch/rev	G98 ... F_ ; G99 ... F_ ;
Chamfering, Corner R		$X_ ; \left\{ \begin{array}{l} C(K) \pm k \\ R_ \end{array} \right\} P_ ;$ $Z_ ; \left\{ \begin{array}{l} C(I) \pm i \\ R_ \end{array} \right\} P_ ;$

(5/5)

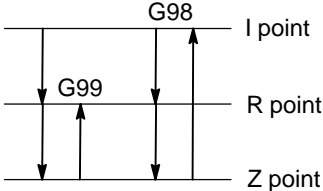
Functions	Illustration	Tape format
Absolute/incremental programming (G90/G91) (With G code system B or C)		G90_ ; Absolute programming G91_ ; Incremental programming G90_ G91_ ; Absolute and incremental programming
Return to initial point/R point (G98, G99) (With G code system B or C)		G98_ ; G99_ ;

B.2
M SERIES

Some functions cannot be added as options depending on the model.
In the tables below, IP _: presents a combination of arbitrary axis addresses using X,Y,Z,A,B and C (such as X_Y_Z_A_).

x = 1st basic axis (X usually)
y = 2nd basic axis (Y usually)
z = 3rd basic axis (Z usually)

(1/6)

Functions	Illustration	Tape format
Positioning (G00)		G00 IP_;
Linear interpolation (G01)		G01 IP_ F_;
Circular interpolation (G02, G03)		$G17 \left\{ \begin{matrix} G02 \\ G03 \end{matrix} \right\} X_ Y_ \left\{ \begin{matrix} R_ \\ I_ J_ \end{matrix} \right\} F_;$ $G18 \left\{ \begin{matrix} G02 \\ G03 \end{matrix} \right\} X_ Z_ \left\{ \begin{matrix} R_ \\ I_ K_ \end{matrix} \right\} F_;$ $G19 \left\{ \begin{matrix} G02 \\ G03 \end{matrix} \right\} Y_ Z_ \left\{ \begin{matrix} R_ \\ J_ K_ \end{matrix} \right\} F_;$
Helical interpolation (G02, G03)		$G17 \left\{ \begin{matrix} G02 \\ G03 \end{matrix} \right\} X_ Y_ \left\{ \begin{matrix} R_ \\ I_ J_ \end{matrix} \right\} \alpha_ F_;$ $G18 \left\{ \begin{matrix} G02 \\ G03 \end{matrix} \right\} X_ Z_ \left\{ \begin{matrix} R_ \\ I_ K_ \end{matrix} \right\} \alpha_ F_;$ $G19 \left\{ \begin{matrix} G02 \\ G03 \end{matrix} \right\} Y_ Z_ \left\{ \begin{matrix} R_ \\ J_ K_ \end{matrix} \right\} \alpha_ F_;$ <p>α: Any address other than that of a circular interpolation axis</p>
Dwell (G04)		G04 $\left\{ \begin{matrix} X_ \\ P_ \end{matrix} \right\}$;
Cylindrical interpolation (G07.1)		G07.1 IP_R_ ; Cylindrical interpolation mode R : Radius of cylinder G07.1 IP 0 ; Cylindrical interpolation mode cancel

(2/6)

Functions	Illustration	Tape format
Advanced preview control (G08)		G08 P1 ; Advanced preview control mode on G08 P0 ; Advanced preview control mode off
Exact stop (G09)		G09 { G01 G02 G03 } IP_;
Change of offset value by program (G10)		<ul style="list-style-type: none"> · Tool offset memory A G10 L11 P_ R_ ; · Tool offset memory B G10 L10 P_ R_ ; (Geometry offset value) G10 L11 P_ R_ ; (Wear offset value) · Tool offset memory C G10 L10 P_ R_ ; (Geometry offset value/H) G10 L11 P_ R_ ; (Wear offset value/H) G10 L12 P_ R_ ; (Geometry offset value/D) G10 L13 P_ R_ ; (Wear offset value/D)
Polar coordinate input (G15, G16)		G17 G16 Xp_Yp ... ; G18 G16 Zp_Xp ... ; G19 G16 Yp_Zp ... ; G15 ; Cancel
Plane selection (G17, G18, G19)		G17 ; G18 ; G19 ;
Inch/metric conversion (G20, G21)		G20 ; Inch input G21 ; Metric input
Stored stroke check (G22, G23)		G22 X_Y_Z_I_J_K_ ; G23 ; Cancel
Reference position return check (G27)		G27 IP_ ;

(3/6)

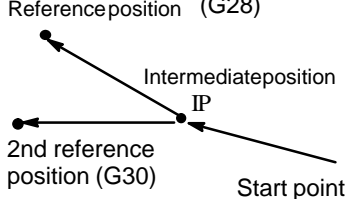
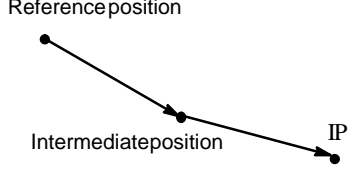
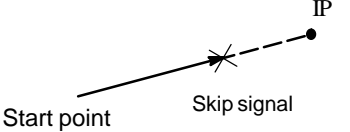
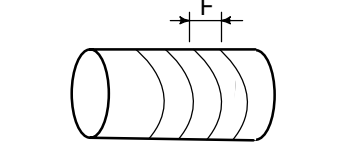
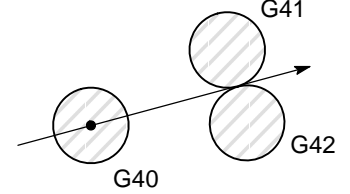
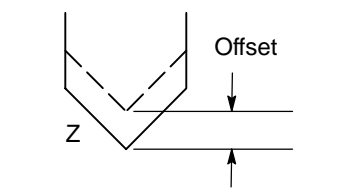
Functions	Illustration	Tape format
Reference position return (G28) 2nd, reference position return (G30)		G28 IP_ ; G30 IP_ ;
Return from reference position (G29)		G29 IP_ ;
Skip function (G31)		G31 IP_ F_ ;
Threading (G33)		G33 IP_ F_ ; F : Lead
Cutter compensation C (G40 to G42)		$\left\{ \begin{matrix} G17 \\ G18 \\ G19 \end{matrix} \right\} \left\{ \begin{matrix} G41 \\ G42 \end{matrix} \right\} D_ ;$ D : Tool offset number G40 : Cancel
Normal-direction control (G40.1, G41.1, G42.1) (G150, G151, G152)		G41.1 (G151) Normal-direction control left G42.1 (G152) Normal-direction control right G40.1 (G150) Normal-direction control cancel
Tool length compensation A (G43, G44, G49)		$\left\{ \begin{matrix} G43 \\ G44 \end{matrix} \right\} Z_ H_ ;$ $\left\{ \begin{matrix} G43 \\ G44 \end{matrix} \right\} H_ ;$ H : Tool offset number G49 : Cancel

(4/6)

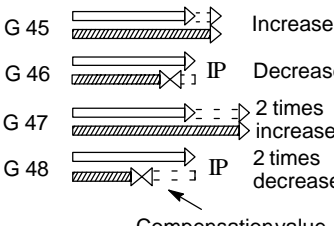
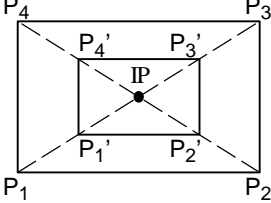
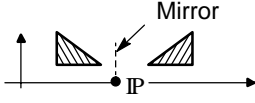
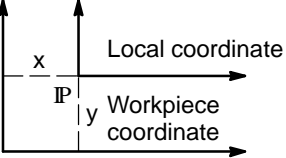
Functions	Illustration	Tape format
Tool length compensation B (G43, G44, G49)		$\left\{ \begin{matrix} G17 \\ G18 \\ G19 \end{matrix} \right\} \left\{ \begin{matrix} G43 \\ G44 \end{matrix} \right\} \left\{ \begin{matrix} Z_ \\ Y_ \\ X_ \end{matrix} \right\} H_ ;$ $\left\{ \begin{matrix} G17 \\ G18 \\ G19 \end{matrix} \right\} \left\{ \begin{matrix} G43 \\ G44 \end{matrix} \right\} H_ ;$ H : Tool offset number G49 : Cancel
Tool length compensation C (G43, G44, G49)		$\left\{ \begin{matrix} G43 \\ G44 \end{matrix} \right\} \alpha_ H_ ;$ α : Any address of a single axis H : Tool offset number G49 : Cancel
Tool offset (G45 to G48)		$\left\{ \begin{matrix} G45 \\ G46 \\ G47 \\ G48 \end{matrix} \right\} IP_ D_ ;$ D : Tool offset number
Scaling (G50, G51)		$G51 X_ Y_ Z_ \left\{ \begin{matrix} P_ \\ I_ J_ K_ \end{matrix} \right\} ;$ P, I, J, K : Scaling magnification X, Y, Z : Coordinates of center of scaling G50 ; Cancel
Programmable mirror image (G50.1, G51.1)		G51.1 IP_ ; G50.1 ; Cancel
Local coordinate system setting (G52)		G52 IP_ ;
Machine coordinate system selection (G53)		G53 IP_ ;

(5/6)

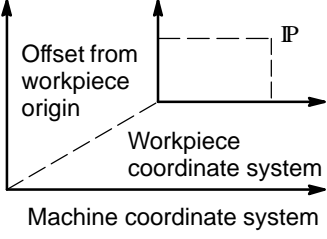
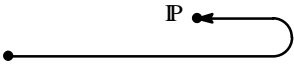
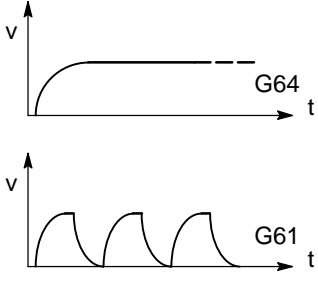
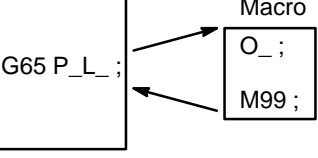
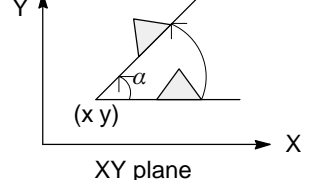
Functions	Illustration	Tape format
Workpiece coordinate system selection (G54 to G59) Additional workpiece coordinate system selection (G54.1)		$\left. \begin{matrix} G54 \\ \vdots \\ G59 \end{matrix} \right\} IP_;$ $G54.1 P_ IP_;$
Single direction positioning (G60)		$G60 IP_;$
Cutting mode Exact stop mode Tapping mode Automatic corner override		$G64_;$ Cutting mode $G61_;$ Exact stop mode $G63_;$ Tapping mode $G62_;$ Automatic corner override
Custom macro (G65, G66, G67)		One-shot call $G65 P_L_ <argument>;$ P : Program number L : Repetition count Continuous-state call $G66 P_L_ <argument>;$ $G67;$ Cancel
Coordinate system rotation (G68, G69)		$G68 \left\{ \begin{matrix} G17 X_Y_ \\ G18 Z_X_ \\ G19 Y_Z_ \end{matrix} \right\} R_\alpha;$ $G69;$ Cancel
Canned cycles (G73, G74, G80 – G89)	Refer to II.14. FUNCTIONS TO SIMPLIFY PROGRAMMING	$G80;$ Cancel $\left. \begin{matrix} G73 \\ G74 \\ G76 \\ G81 \\ \vdots \\ G89 \end{matrix} \right\} X_Y_Z_P_Q_R_F_K_;$
Absolute/incremental programming (G90/G91)		$G90_;$ Absolute command $G91_;$ Incremental command $G90_ G91_;$ Combined use

(6/6)

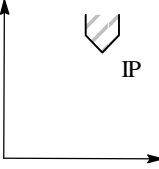
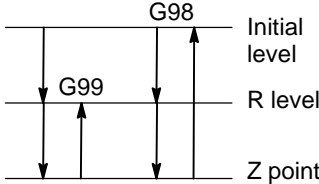
Functions	Illustration	Tape format
Change of workpiece coordinate system (G92)		G92 IP_ ;
Workpiece coordinate system preset (G92.1)		G92.1 IP0 ;
Feed per minute/rotation (G94, G95)	mm/min inch/min mm/rev inch/rev	G98 F_ ; G99 F_ ;
Constant surface speed control (G96, G97)		G96 S_ ; G97 S_ ;
Initial point return / R point return (G98, G99)		G98_ ; G99_ ;

C LIST OF TAPE CODE

ISO code									EIA code									Remarks	Custom macro B		
Character	8	7	6	5	4	3	2	1	Character	8	7	6	5	4	3	2	1				
																					Not used
0			○	○	○				0			○							Number 0		
1	○		○	○	○			○	1					○			○		Number 1		
2	○		○	○	○		○		2					○			○		Number 2		
3			○	○	○		○	○	3			○		○			○		Number 3		
4	○		○	○	○		○		4					○			○		Number 4		
5			○	○	○		○	○	5			○		○			○		Number 5		
6			○	○	○		○	○	6			○		○			○		Number 6		
7	○		○	○	○		○	○	7					○			○		Number 7		
8	○		○	○	○				8				○	○					Number 8		
9			○	○	○			○	9			○	○	○			○		Number 9		
A		○				○		○	a		○	○		○			○		Address A		
B		○				○		○	b		○	○		○			○		Address B		
C	○	○				○		○	c		○	○	○	○			○		Address C		
D		○				○		○	d		○	○		○			○		Address D		
E	○	○				○		○	e		○	○	○	○			○		Address E		
F	○	○				○		○	f		○	○	○	○			○		Address F		
G		○				○		○	g		○	○		○			○		Address G		
H		○			○	○			h		○	○		○					Address H		
I	○	○			○	○		○	i		○	○	○	○			○		Address I		
J	○	○			○	○		○	j		○	○		○			○		Address J		
K		○			○	○		○	k		○	○		○			○		Address K		
L	○	○			○	○			l		○			○			○		Address L		
M		○			○	○		○	m		○	○		○					Address M		
N		○			○	○		○	n		○			○			○		Address N		
O	○	○			○	○		○	o		○			○			○		Address O		
P		○		○	○				p		○	○		○			○		Address P		
Q	○	○		○	○			○	q		○	○	○	○					Address Q		
R	○	○		○	○		○		r		○			○			○		Address R		
S		○		○	○		○	○	s			○	○	○			○		Address S		
T	○	○		○	○		○		t			○		○			○		Address T		
U		○		○	○		○		u			○	○	○					Address U		
V		○		○	○		○		v			○		○			○		Address V		
W	○	○		○	○		○	○	w			○		○			○		Address W		
X	○	○		○	○		○		x			○	○	○			○		Address X		
Y		○		○	○		○		y			○	○	○					Address Y		

ISO code									EIA code									Remarks	Custom macro B	
Character	8	7	6	5	4	3	2	1	Character	8	7	6	5	4	3	2	1		Not used	Used
Z		○		○	○	○		○	z			○		○			○	Address Z		
DEL	○	○	○	○	○	○	○	○	Del		○	○	○	○	○	○	○	Delete (deleting a mispunch)	×	×
NUL								○	Blank								○	No. punch. With EIA code, this code cannot be used in a significant information section.	×	×
BS	○			○	○				BS			○	○	○		○		Backspace	×	×
HT				○	○			○	Tab			○	○	○	○	○	○	Tabulator	×	×
LF or NL				○	○			○	CR or EOB	○								End of block		
CR	○			○	○	○		○	___								○	Carriage return	×	×
SP	○	○				○			SP				○	○				Space	□	□
%	○	○				○	○		ER					○	○		○	Absolute rewind stop		
(○	○	○				(2-4-5)				○	○	○		○	Control out (start of comment)		
)	○	○		○	○			○	(2-4-7)		○			○	○		○	Control in (end of comment)		
+			○	○	○		○	○	+		○	○	○	○				Plus sign	△	
-			○	○	○		○	○	-		○						○	Minus sign		
:			○	○	○			○	___								○	Colon (address O)		
/	○	○		○	○	○	○	○	/			○	○				○	Optional block skip		
.			○	○	○		○	○	.		○	○		○			○	Period (decimal point)		
#	○	○				○		○	Parameter (No. 6012)								○	Sharp		
\$			○			○	○		___								○	Dollar sign	×	×
&	○	○				○	○	○	&					○	○	○	○	Ampersand	△	○
'			○			○	○	○	___								○	Apostrophe	△	△
*	○	○		○	○			○	Parameter (No. 6010)								○	Asterisk	△	
,	○	○		○	○				,			○	○	○	○		○	Comma		
;	○	○	○	○	○			○	___								○	Semicolon	×	×
<			○	○	○												○	Left angle bracket	△	△

ISO code								EIA code								Remarks	Custom macro B			
Character	8	7	6	5	4	3	2	1	Character	8	7	6	5	4	3		2	1	Not used	Used
=	○		○	○	○	○	○	○	Parameter (No. 6011)						○			Equal sign	△	
>	○		○	○	○	○	○	○	—						○			Right angle bracket	△	△
?			○	○	○	○	○	○	—						○			Question mark	△	○
@	○	○					○		—						○			Commercial at mark	△	○
”			○					○	—						○			Quotation mark	△	△
[○	○		○	○	○		○	Parameter (No. 6013)						○			Left square bracket	△	
]	○	○		○	○	○		○	Parameter (No. 6014)						○			Right square bracket	△	

NOTE

- The symbols in the Remarks column have the following meanings:
 Blank: Registered in memory as significant information. Any invalid use of these codes in information other than a comment will cause an alarm.
 × : Not registered in memory (ignored)
 △ : Registered in memory but ignored during the execution of a program
 ○ : Registered in memory. The use of these codes in information other than a comment will cause an alarm.
 □ : Not registered in memory when used in information other than a comment. Registered in memory when used in a comment.
- Any code other than those listed in the table is always ignored, provided its parity is valid.
- Any code having an invalid parity will cause a TH alarm. Within a comment, however, such a code is ignored and will not cause a TH alarm.
- With EIA code, the code with all eight holes punched has special meaning. It is ignored and does not cause any parity alarm.

D EXTERNAL DIMENSIONS OF EACH UNIT

(Outline Drawings of the *i* Series CNC with a LCD-mounted Type Panel)

Outline drawing title		Specification drawing number		Figure
Series 16 <i>i</i> /18 <i>i</i> /21 <i>i</i> /20 <i>i</i> control unit	7.2" STN monochrome LCD panel	16 <i>i</i>	A02B-0281-B500,B502,B503,B504 A02B-0281-H124	Fig.U1
		18 <i>i</i>	A02B-0283-B500,B502,B503,B504 A02B-0281-H124	
		18 <i>i</i> -MB5	A02B-0297-B500,B502,B503,B504 A02B-0281-H124	
		21 <i>i</i>	A02B-0285-B500,B502,B503,B504 A02B-0281-H124	
	8.4" TFT color LCD panel	16 <i>i</i>	A02B-0281-B500,B502,B503,B504 A02B-0281-H123	Fig.U2
		18 <i>i</i>	A02B-0283-B500,B502,B503,B504 A02B-0281-H123	
		18 <i>i</i> -MB5	A02B-0297-B500,B502,B503,B504 A02B-0281-H123	
		21 <i>i</i>	A02B-0285-B500,B502,B503,B504 A02B-0281-H123	
		20 <i>i</i>	A02B-0287-B500,B502 A02B-0281-H123	
	9.5" STN monochrome LCD panel	16 <i>i</i>	A02B-0281-B500,B502,B503,B504 A02B-0281-H122	Fig.U3
		18 <i>i</i>	A02B-0283-B500,B502,B503,B504 A02B-0281-H122	
		18 <i>i</i> -MB5	A02B-0297-B500,B502,B503,B504 A02B-0281-H122	
		21 <i>i</i>	A02B-0285-B500,B502,B503,B504 A02B-0281-H122	
	10.4" TFT color LCD panel	16	A02B-0281-B500,B502,B503,B504 A02B-0281-H120,H121	Fig.U4
		18 <i>i</i>	A02B-0283-B500,B502,B503,B504 A02B-0281-H120,H121	
		18 <i>i</i> -MB5	A02B-0297-B500,B502,B503,B504 A02B-0281-H120,H121	
21 <i>i</i>		A02B-0285-B500,B502,B503,B504 A02B-0281-H120,H121		

(Outline Drawings of the *i* Series CNC with a Stand-alone Type Unit)

Series 16 <i>i</i> and Series 160 <i>i</i> control units	A02B-0281-B801, B803	Fig. U6
Series 18 <i>i</i> and Series 180 <i>i</i> control units	A02B-0283-B801, B803	
Series 18 <i>i</i> -MB5 and Series 180 <i>i</i> -MB5 control units	A02B-0297-B801, B803	
Series 21 <i>i</i> and Series 210 <i>i</i> control units	A02B-0285-B801, B803	
10.4"/9.5" LCD unit	A02B-0281-C071, C081, C061, C066	Fig. U7
7.2" LCD/MDI unit (Unit applied to display link)	A02B-0166-C261#TR, R, TS, S	Fig. U8
7.2" monochrome LCD unit (Unit applied to display link)	A02B-0166-C251	Fig. U9
MDI unit (for 7.2" LCD) (Unit applied to display link)	A02B-0166-C210#TR, TS, R, S	Fig. U10
Detachable 7.2" LCD/MDI unit (Unit applied to display link)	A02B-0166-C271#TR, TS, R, S	Fig. U11

(Outline Drawings of PANEL *i* (CNC display unit with PC functions))

PANEL <i>i</i> (CNC display unit with PC functions)	10.4" TFT color LCD panel	A08B-0082-B001 to -B004 A08B-0082-B031 to -B038 A08B-0193-B031 to -B038	Fig.U12(a)
	12.1" TFT color LCD panel	A08B-0082-B011 to -B014 A08B-0082-B041 to -B048 A08B-0193-B041 to -B048	Fig.U12(b)
	15.0" TFT color LCD panel	A08B-0082-B021 and -B023 A08B-0082-B051 to -B057 A08B-0193-B051 to -B057	Fig.U12(c)

(Outline drawings of other units)

Stand-alone type small MDI unit	For 7.2"/8.4" LCD unit	A02B-0281-C120#TBR, MBR, TBS, MBS, TBE, MBE	Fig.U13
Stand-alone type standard MDI unit	For 7.2"/8.4" LCD unit	A02B-0281-C121#TBR, MBR, TBS, MBS, TBE, MBE	Fig.U14
Stand-alone type standard MDI unit (horizontal type)	For 9.5"/10.4" LCD unit	A02B-0281-C125#TBR, MBR, TBS, MBS, TFBR, TFBS, TBE, MBE	Fig.U15
Stand-alone type standard MDI unit (vertical type)	For 9.5"/10.4" LCD unit	A02B-0281-C126#TBR, MBR, TBS, MBS, TFBR, TFBS, TBE, MBE	Fig.U16
FA full keyboard	For 10.4" LCD unit	A02B-0236-C131#EC, JC	Fig.U17(a)
FA full keyboard	For 12.1" LCD unit	A02B-0236-C132#EC, JC	Fig.U17(b)
FA full keyboard	For 15.0" LCD unit	A08B-0082-C150#EC, JC	Fig.U17(c)
Full keyboard (for debugging purposes)		A86L-0001-0210, 0211	Fig.U18
Mouse (for debugging purposes)		A86L-0001-0212	Fig.U19
Floppy disk unit (for debugging purposes)		A02B-0207-C008	Fig.U20
HSSB interface board type 2 (1CH) on the personal computer side (ISA)		A20B-8001-0583	Fig.U21(a)
HSSB interface board type 2 (2CH) on the personal computer side (ISA)		A20B-8001-0582	
HSSB interface board type 2 (1CH) on the personal computer side (PCI)		A20B-8001-0961	Fig.U21(b)
HSSB interface board type 2 (2CH) on the personal computer side (PCI)		A20B-8001-0960	
Position coder	4000min ⁻¹	A86L-0027-0001#102	Fig.U22(a)
	6000min ⁻¹	A86L-0027-0001#002	
α position coder	10000mi ⁻¹	A860-0309-T302	Fig.U22(b)
Manual pulse generator		A860-0202-T001	Fig.U23
Pendant manual pulse generator		A860-0202-T004 to T015	Fig.U24
Separate detector interface unit		A02B-0236-C205, C204	Fig.U25
Battery case for separate detector interface unit (ABS)		A06B-6050-K060	Fig.U26
Tap unit for DNC1		A13B-0156-C100	Fig.U27
Terminating resistance unit for DNC1		A13B-0156-C200	Fig.U28

CNC battery unit for external installation		A02B-0236-C281	Fig.U29
Punch panel (narrow type)	1m	A02B-0236-C191	Fig.U30
	2m	A02B-0236-C192	
	5m	A02B-0236-C193	
Punch panel	1m	A02B-0120-C191	Fig.U31
	2m	A02B-0120-C192	
	5m	A02B-0120-C193	
Distribution I/O small machine operator's panel		A02B-0236-C141#TBR, MBR, TBS, MBS	Fig.U32
Distribution I/O standard machine operator's panel		A02B-0236-C140#TBR, MBR, TBS, MBS	Fig.U33
61-key MDI unit (vertical type)	For 9.5"/10.4" LCD unit	A02B-0261-C161#MCR, MCS A02B-0261-C163#MCR, MCS	Fig.U34
61-key MDI unit (horizontal type)	For 9.5"/10.4" LCD unit	A02B-0261-C162#MCR, MCS A02B-0261-C164#MCR, MCS	Fig.U35
61-key MDI unit (horizontal type)	For 12.1" LCD unit	A02B-0261-C165#MCR, MCS	Fig.U36
61-key MDI unit (horizontal type)	For 12.1" LCD unit	A02B-0261-C166#MCR, MCS	Fig.U37
Blank panel	Supplied with the 61-key MDI unit (A02B-0261-C165, C166).		Fig.U38
Distribution I/O machine operator's panel (290mm wide)		A02B-0236-C150#TBR, MBR, TBS, MBS	Fig.U39
Stand-alone type standard MDI unit for 160i/180i/210i	For 10.4" (vertical type)	A02B-0281-C327#TBR, MBR, TBS, MBS	Fig.U40(a)
	For 10.4" (horizontal type)	A02B-0281-C320#TBR, MBR, TBS, MBS	Fig.U40(b)

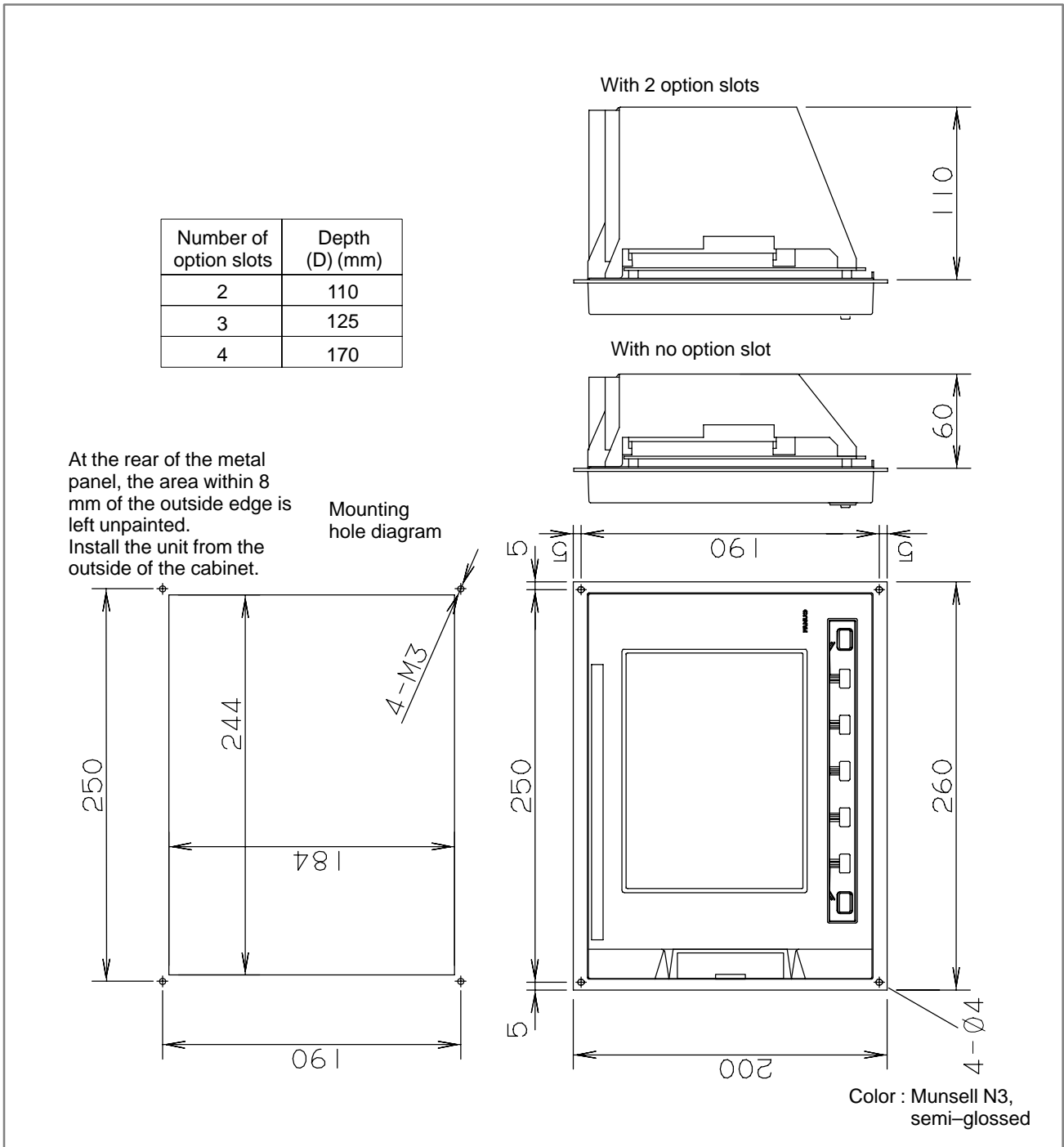

Fig. U1 External dimensions of 7.2" LCD-mounted type CNC control unit

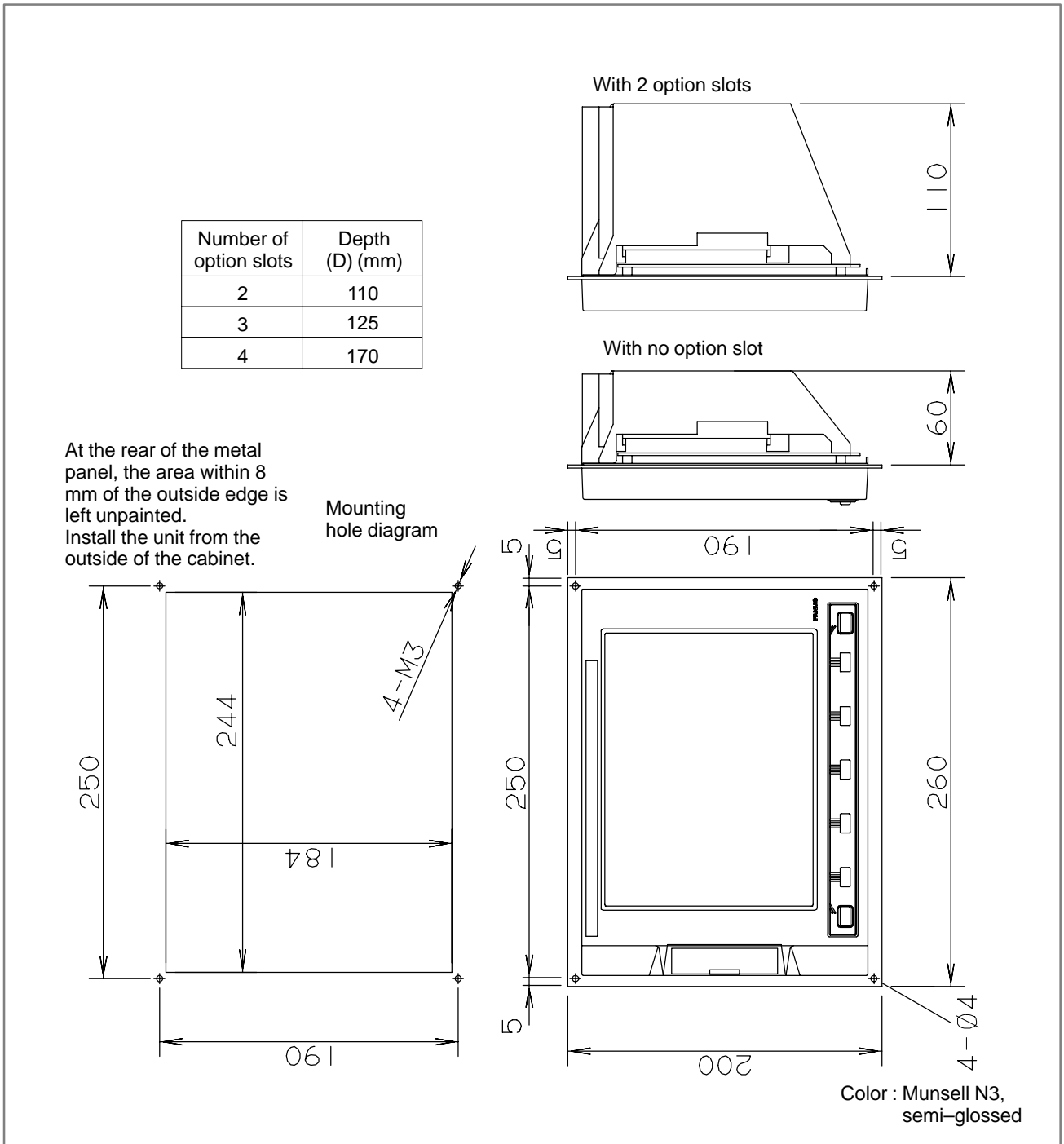

Fig. U2 External dimensions of 8.4" LCD-mounted type CNC control unit

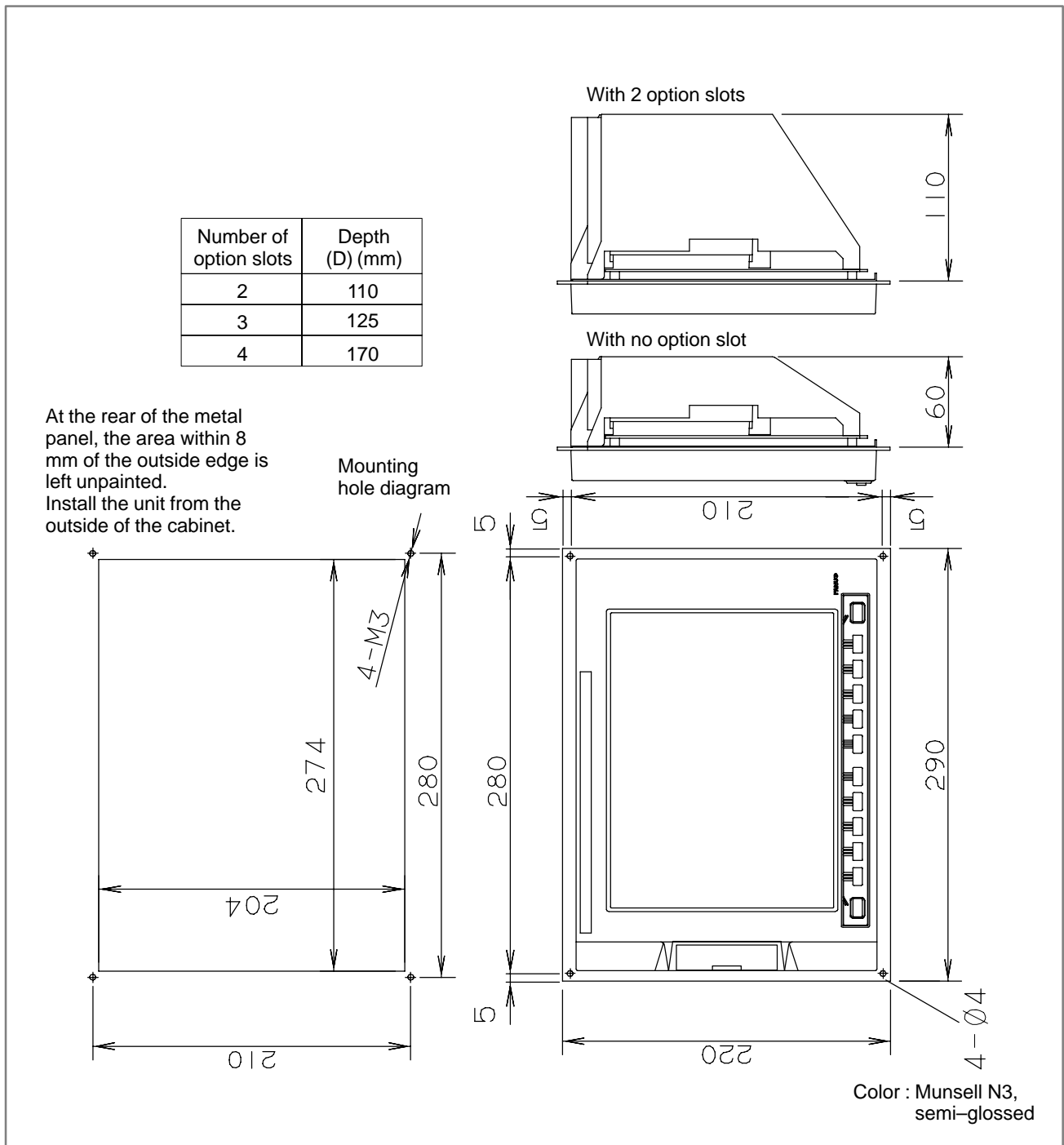

Fig. U3 External dimensions of 9.5" LCD-mounted type CNC control unit

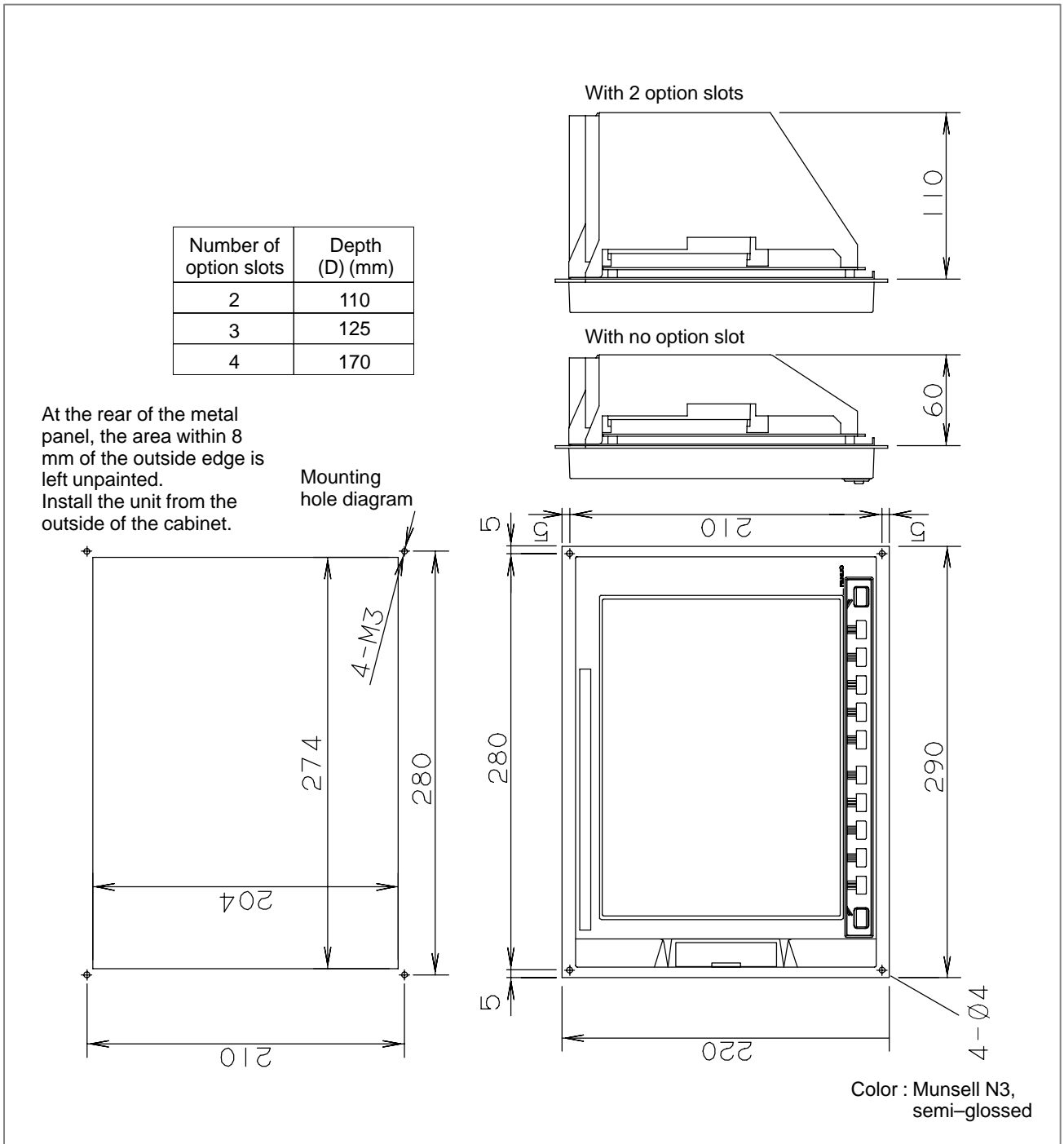

Fig. U4 External dimensions of 10.4" LCD-mounted type CNC control unit

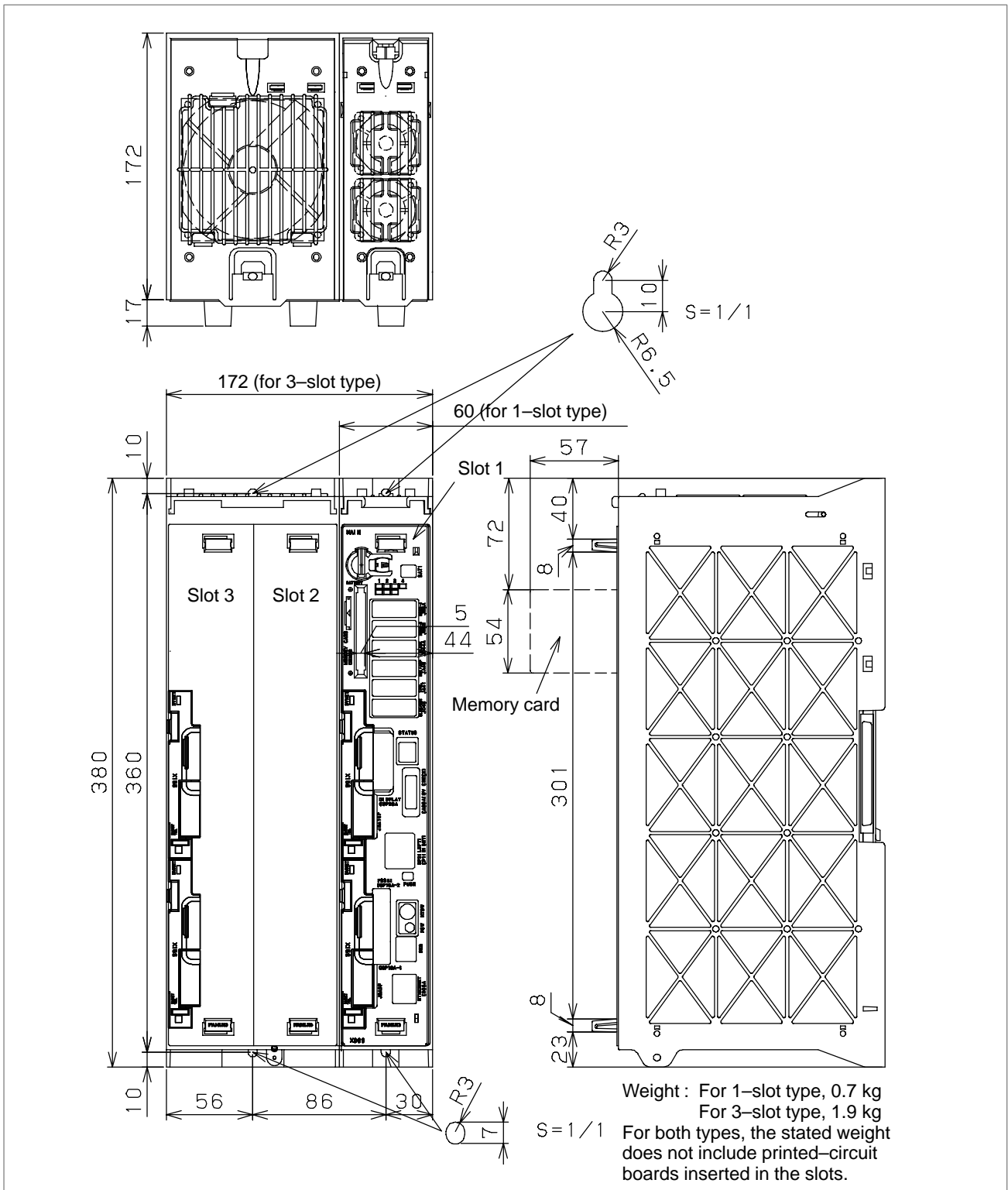
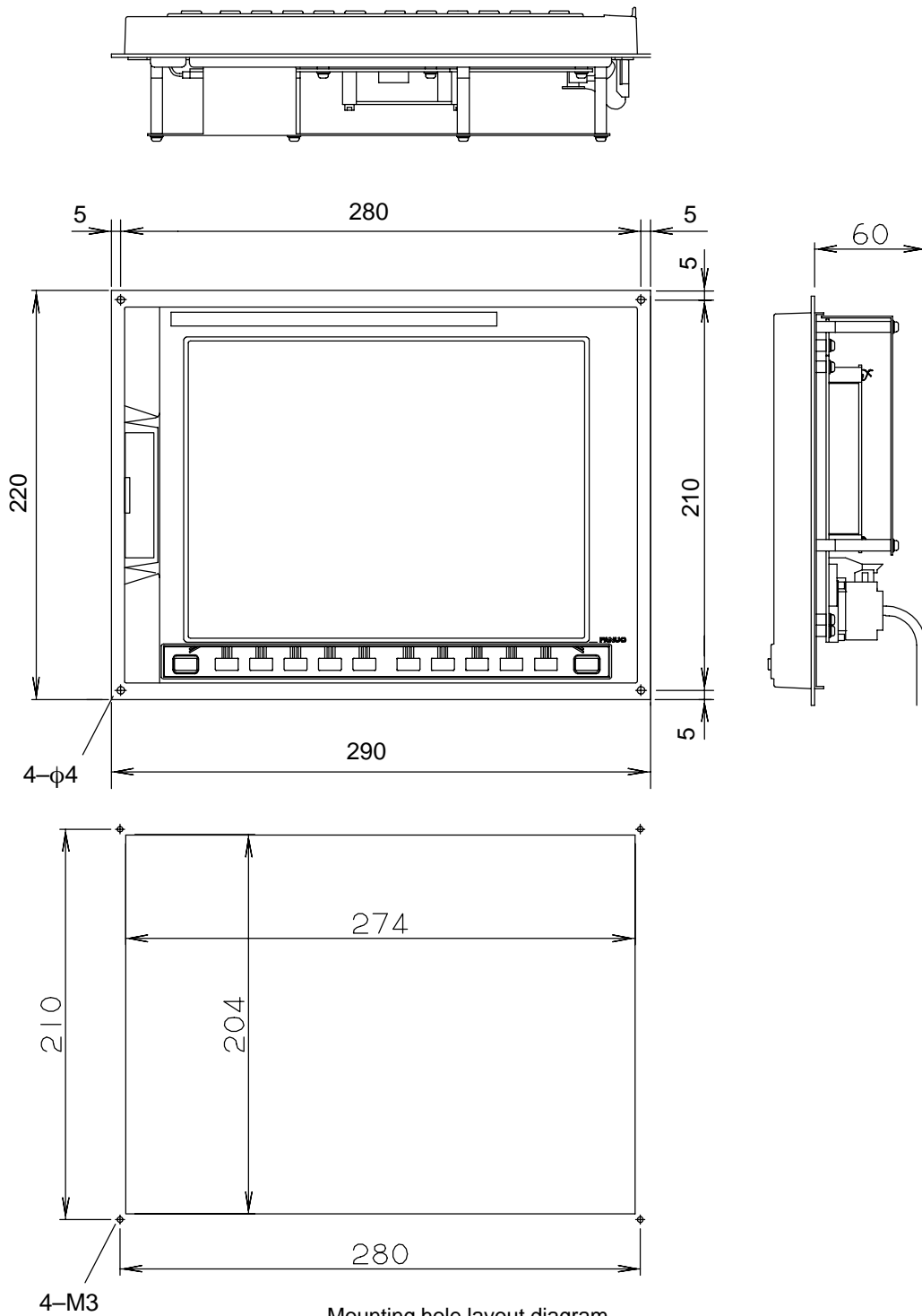

Fig. U6 Stand-alone Type *i* Series Control Unit



Mounting hole layout diagram
(The unit shall be fastened to the cabinet from the outside.)
Painting shall be masked 8 mm from the edges of the panel sheet metal
on the rear surface.

Paint color: Munsell code N3, medium gloss

Fig. U7 10.4"/9.5" LCD Unit

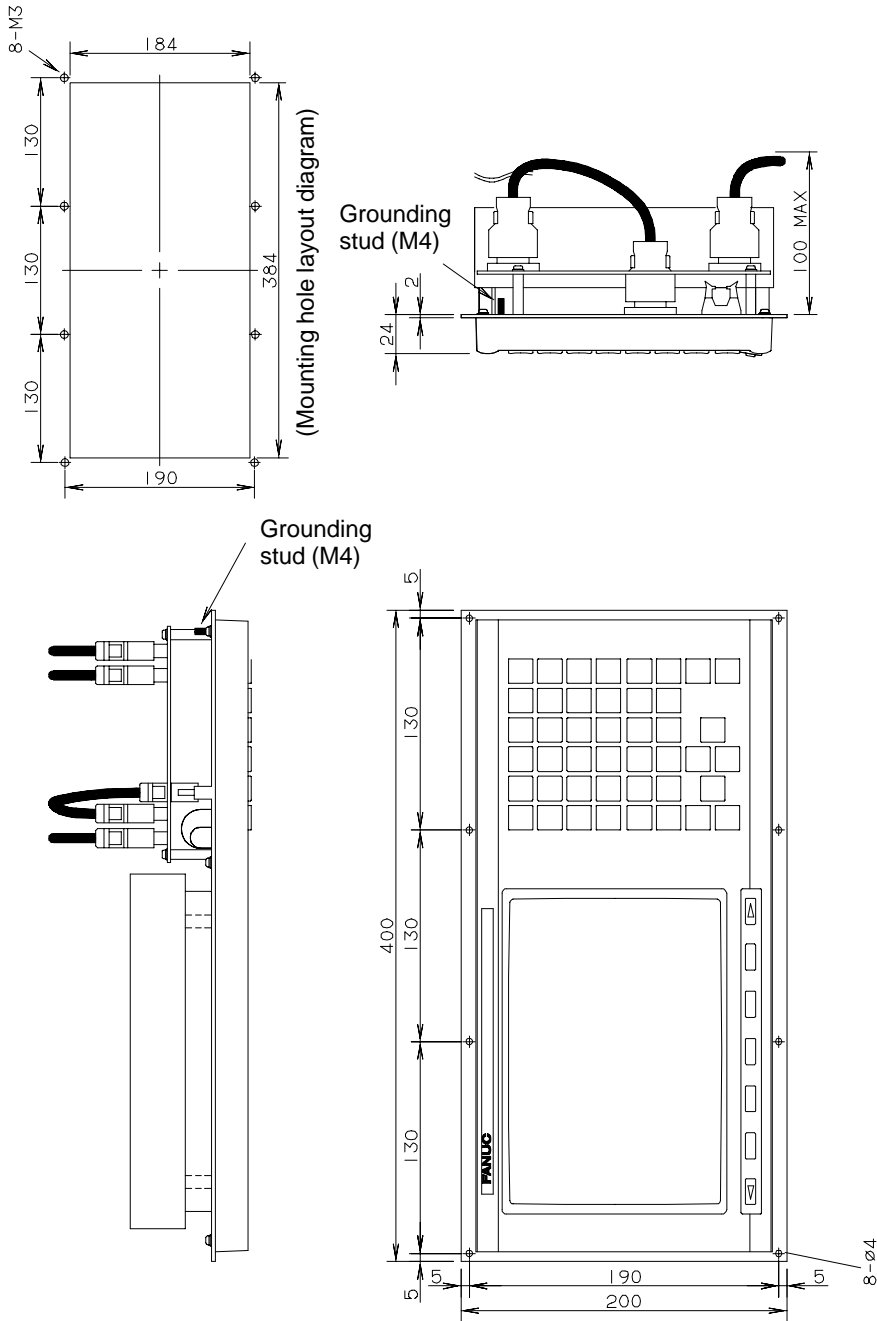

The unit shall be fastened to the cabinet from the outside.

Weight: 3.9 kg

Paint color: Munsell code N3, medium gloss

Fig. U8 7.2" LCD/MDI Unit Outline Drawing (Unit applied to display link)

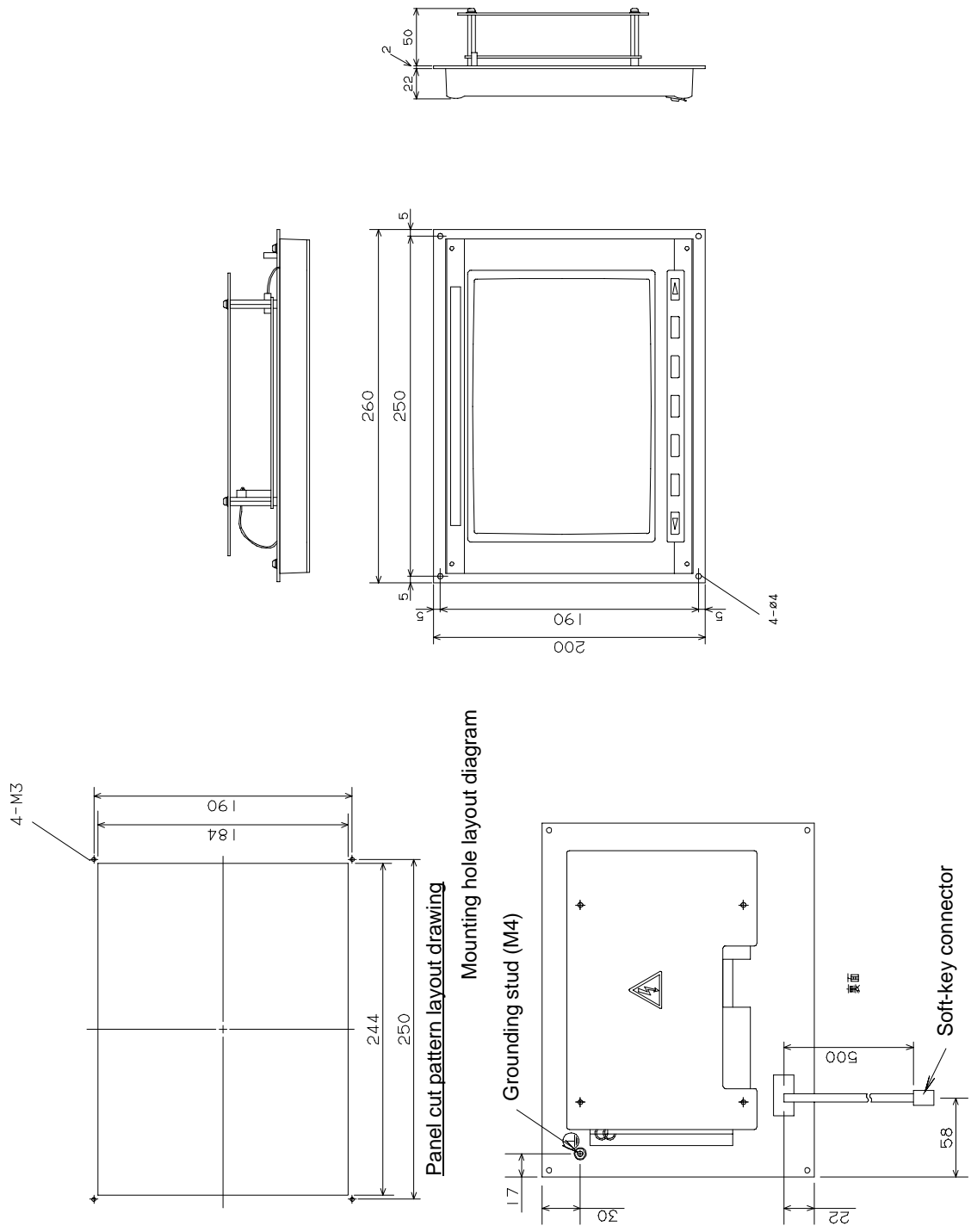

The unit shall be fastened to the cabinet from the outside.

Weight: 1.6 kg

Paint color: Munsell code N3, medium gloss

Fig. U9 7.2" Monochrome LCD Unit Outline Drawing (Unit applied to display link)

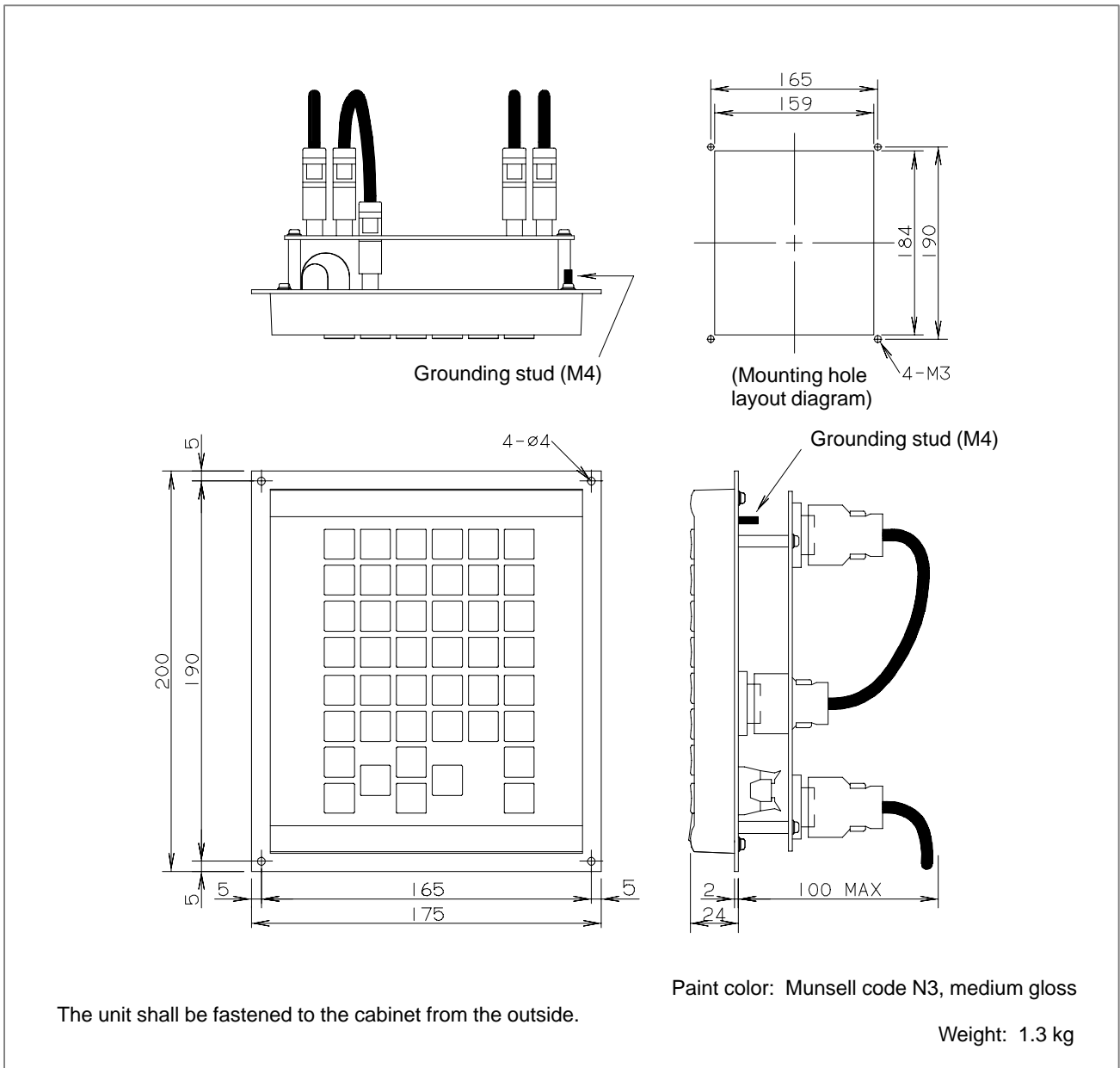

Fig. U10 Stand-alone type MDI Unit (for 7.2" Stand-alone type LCD) (Unit applied to display link)

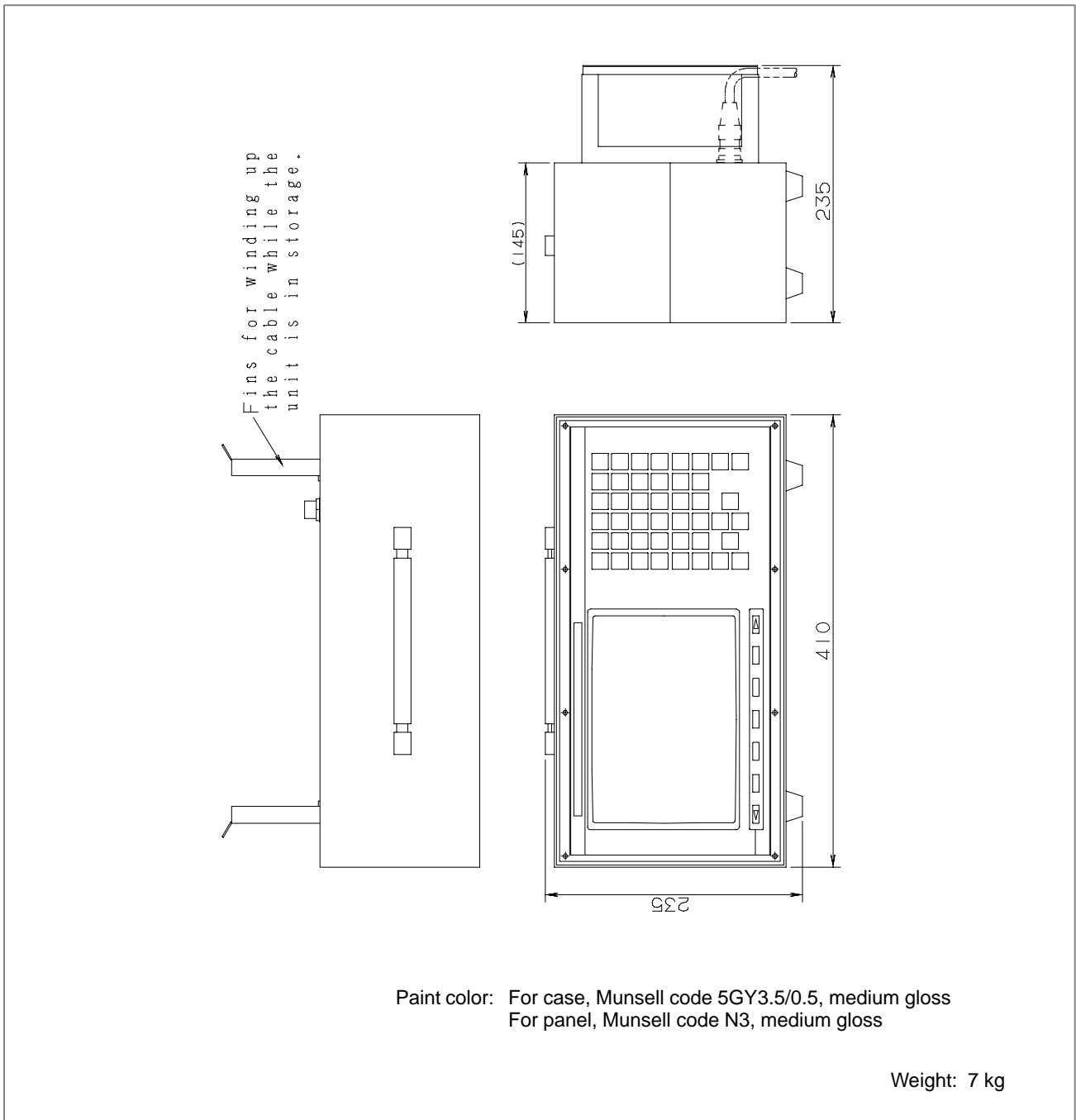

Fig. U11 Detachable 7.2" LCD/MDI Unit (Unit applied to display link)

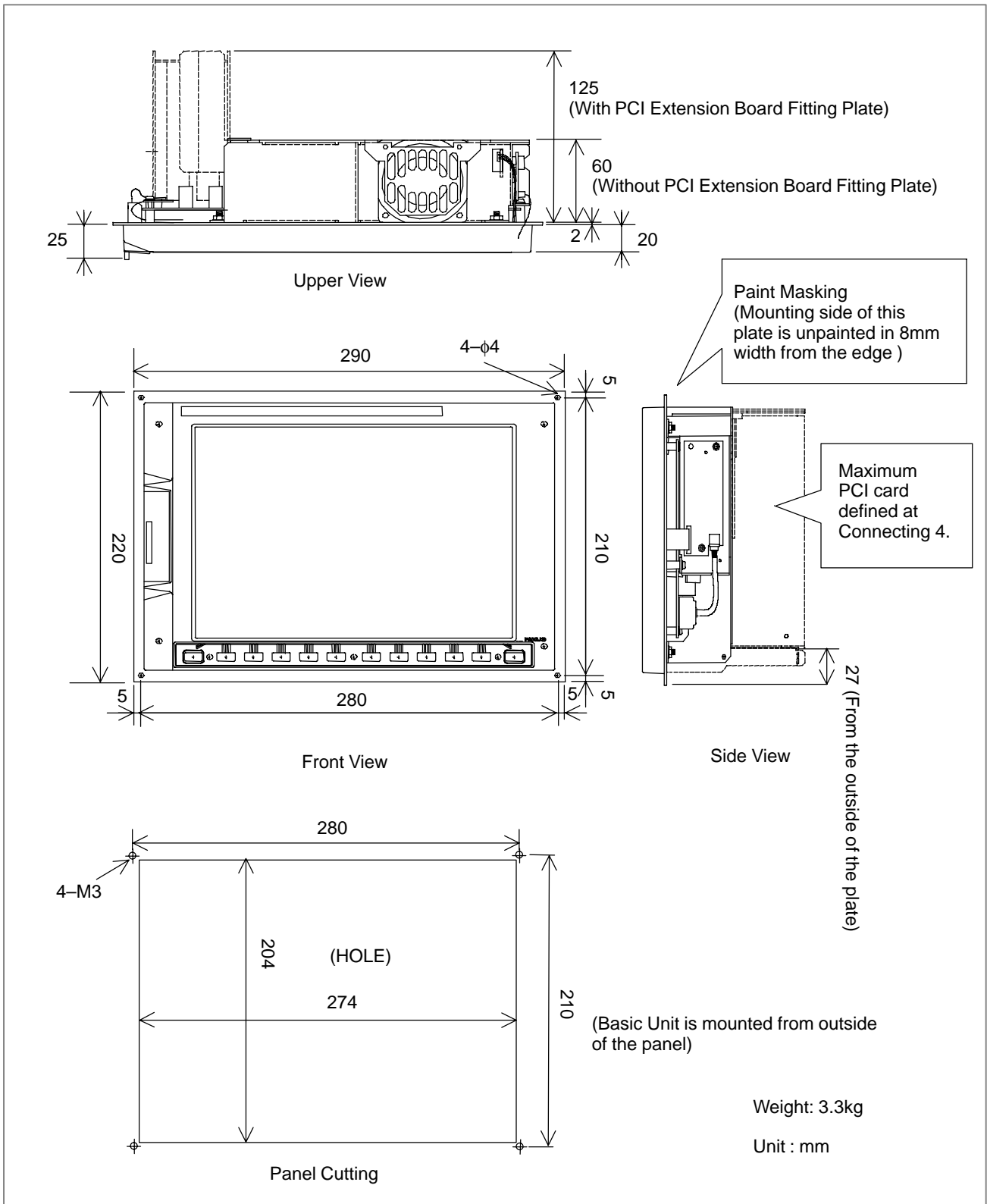

Fig. U12 (a) External dimensions of 10.4" TFT color LCD of PANEL *i* (CNC display unit with PC functions)

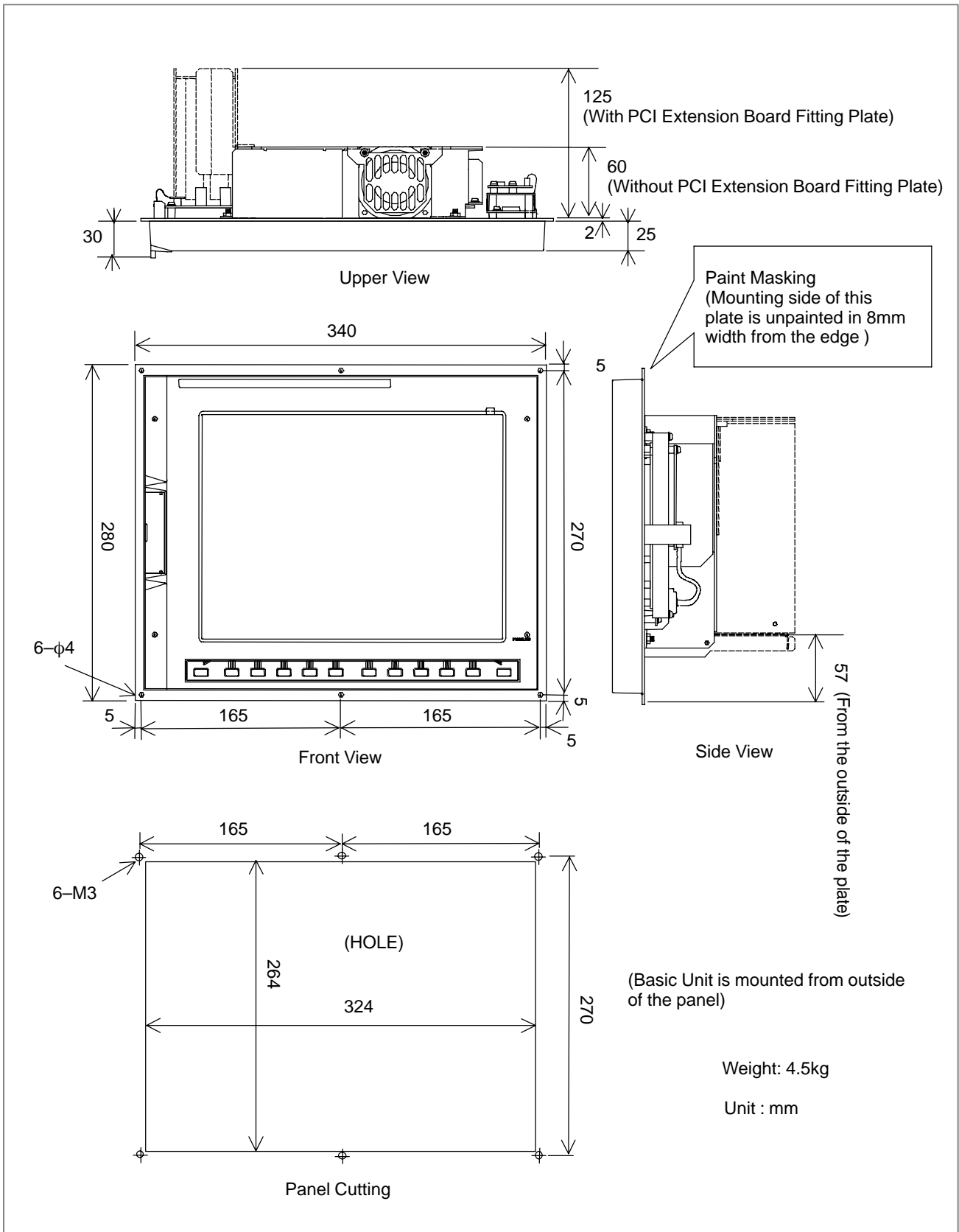

Fig. U12 (b) External dimensions of 12.1" TFT color LCD of PANEL i (CNC display unit with PC functions)

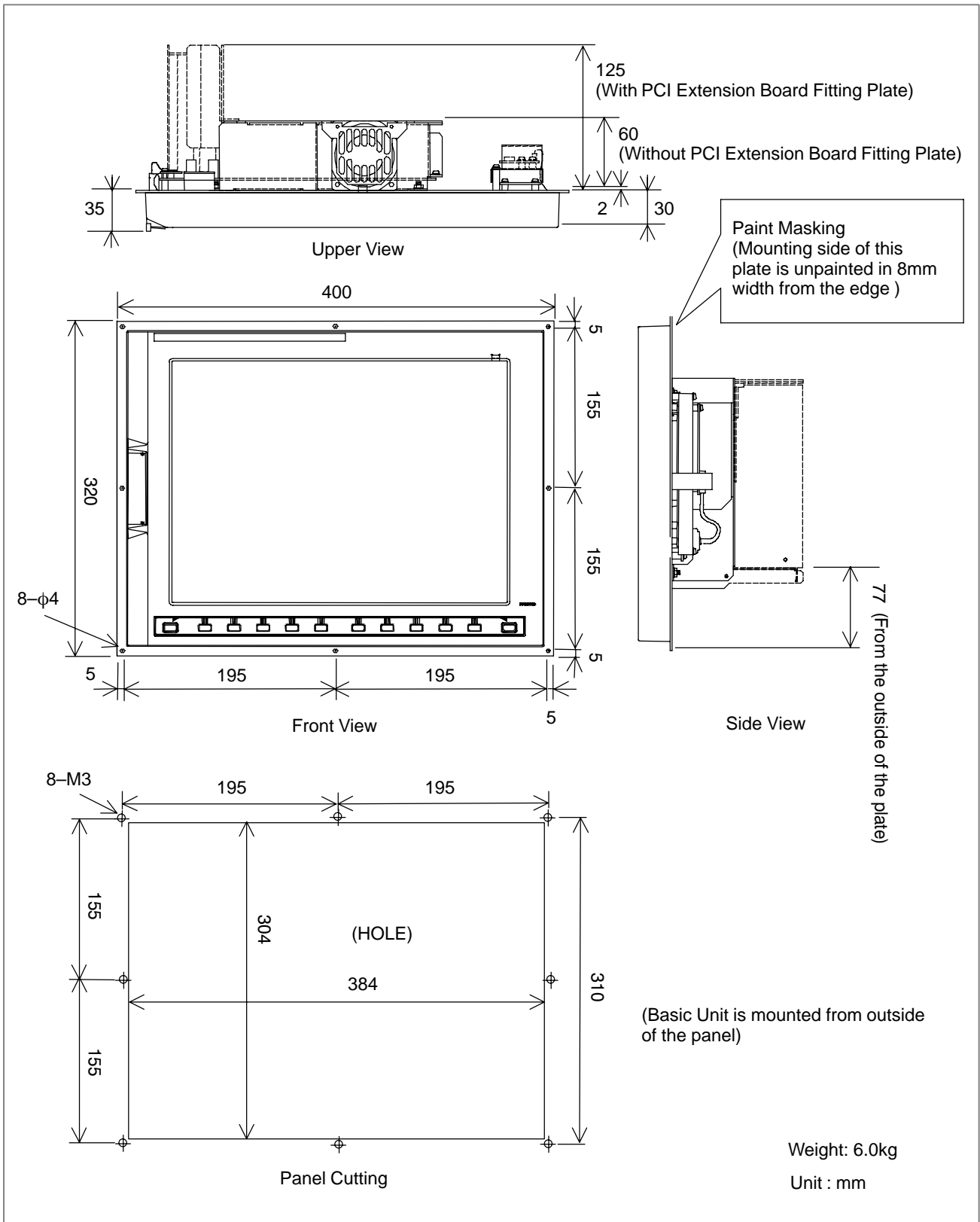

Fig. U12 (c) External dimensions of 15.0" TFT color LCD of PANEL i (CNC display unit with PC functions)

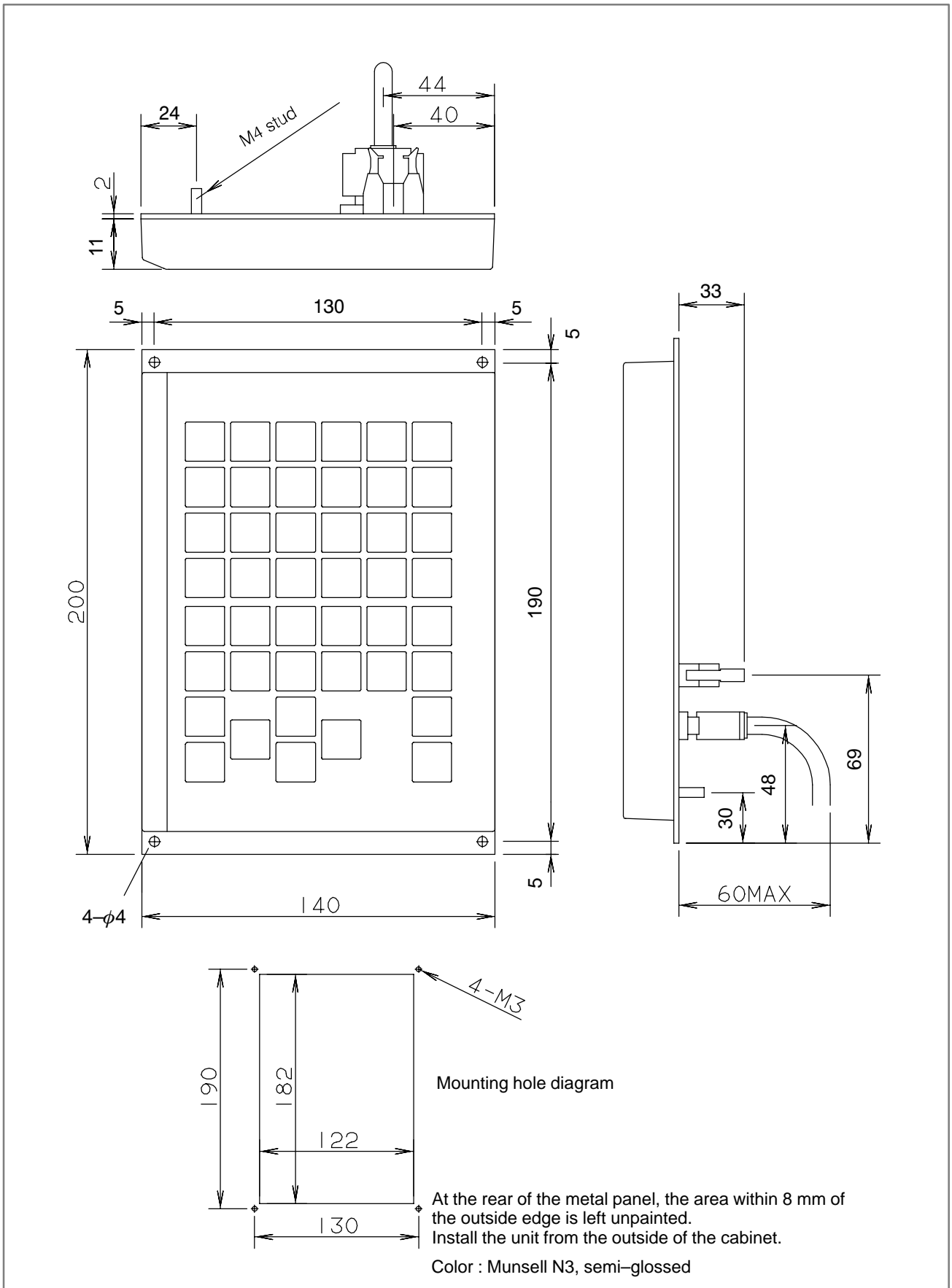

Fig. U13 External dimensions of stand-alone type small-size MDI unit

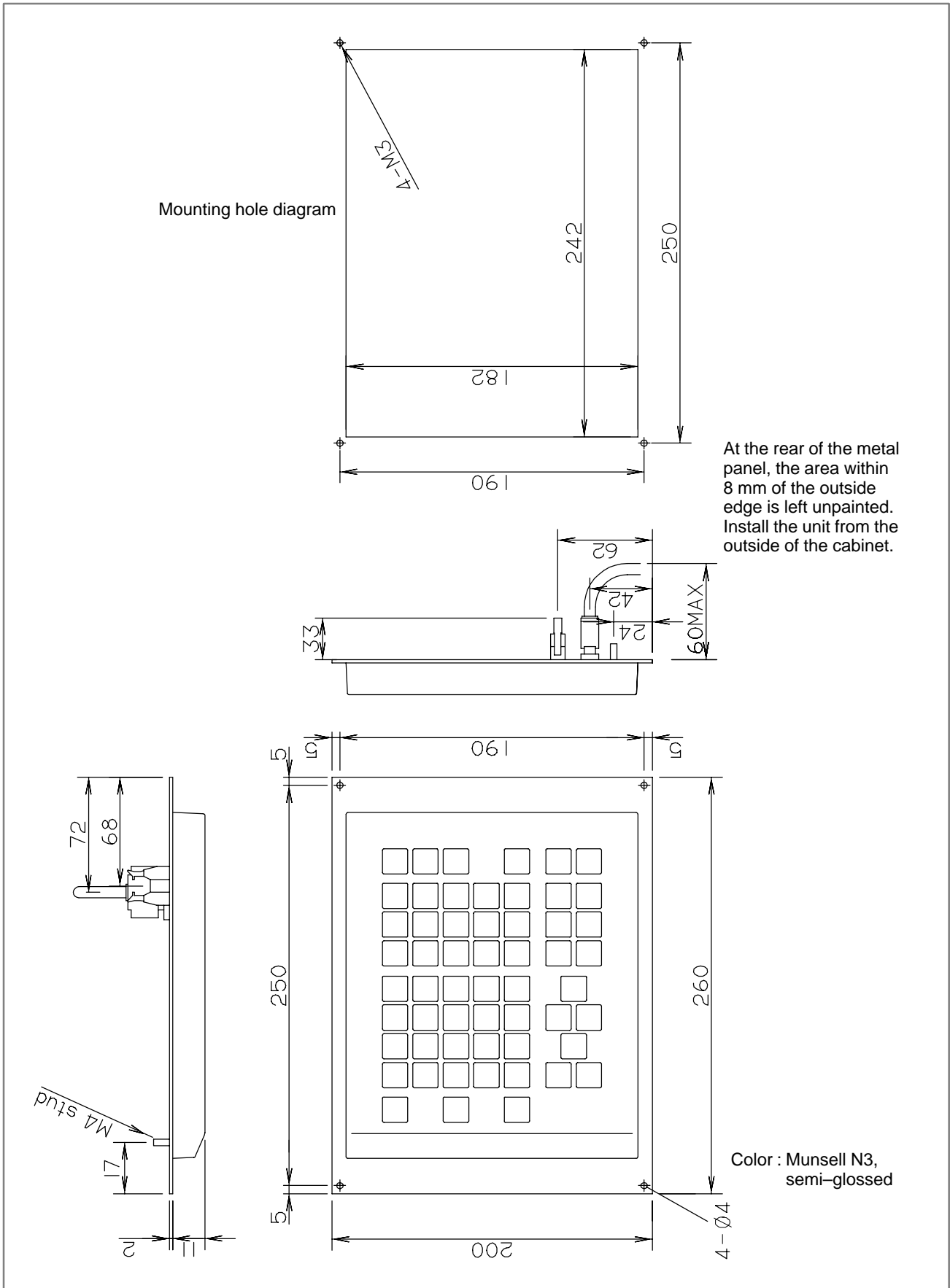

Fig. U14 External dimensions of stand-alone type standard MDI unit

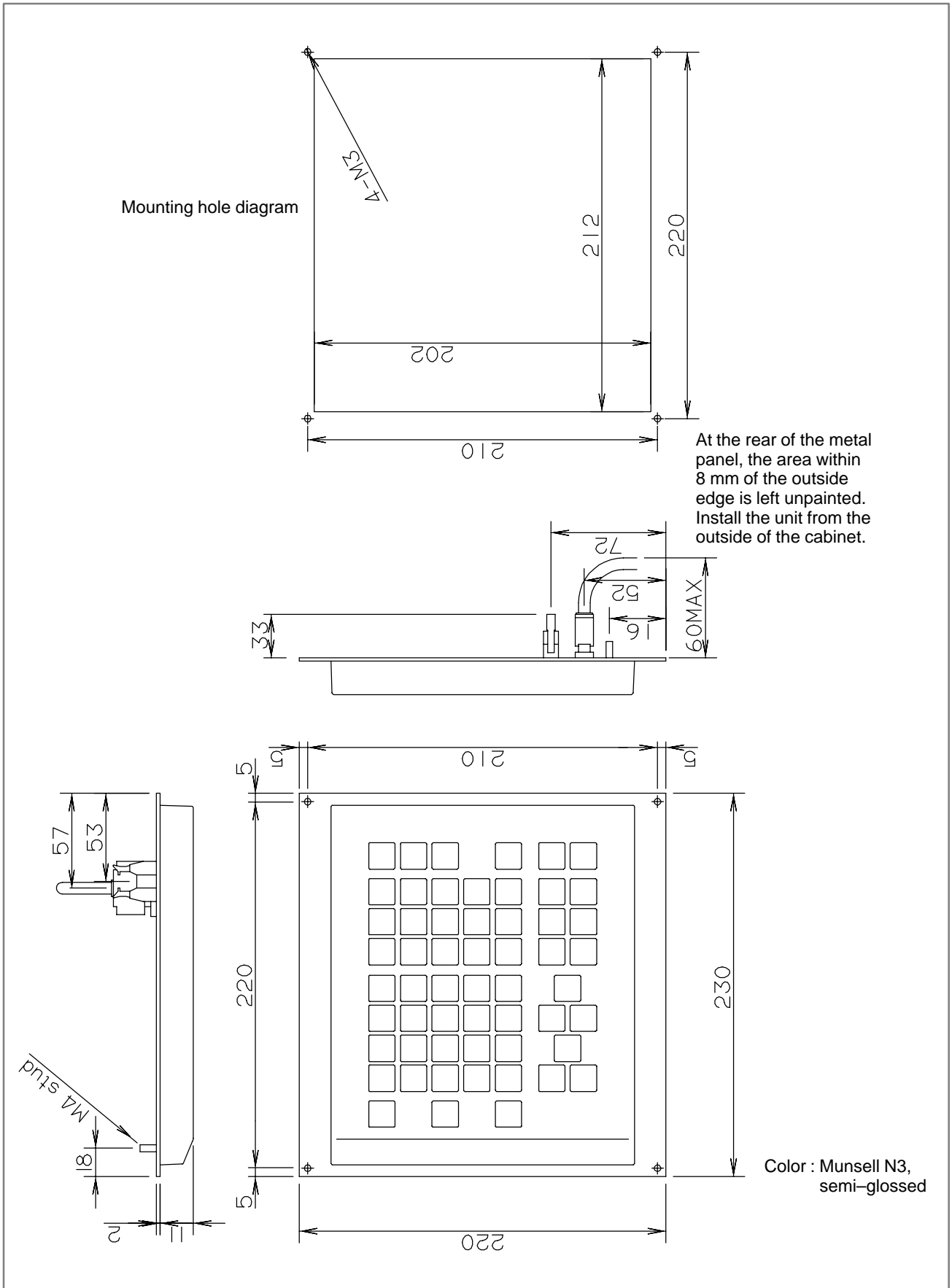

Fig. U15 External dimensions of stand-alone type standard MDI unit (horizontal type)

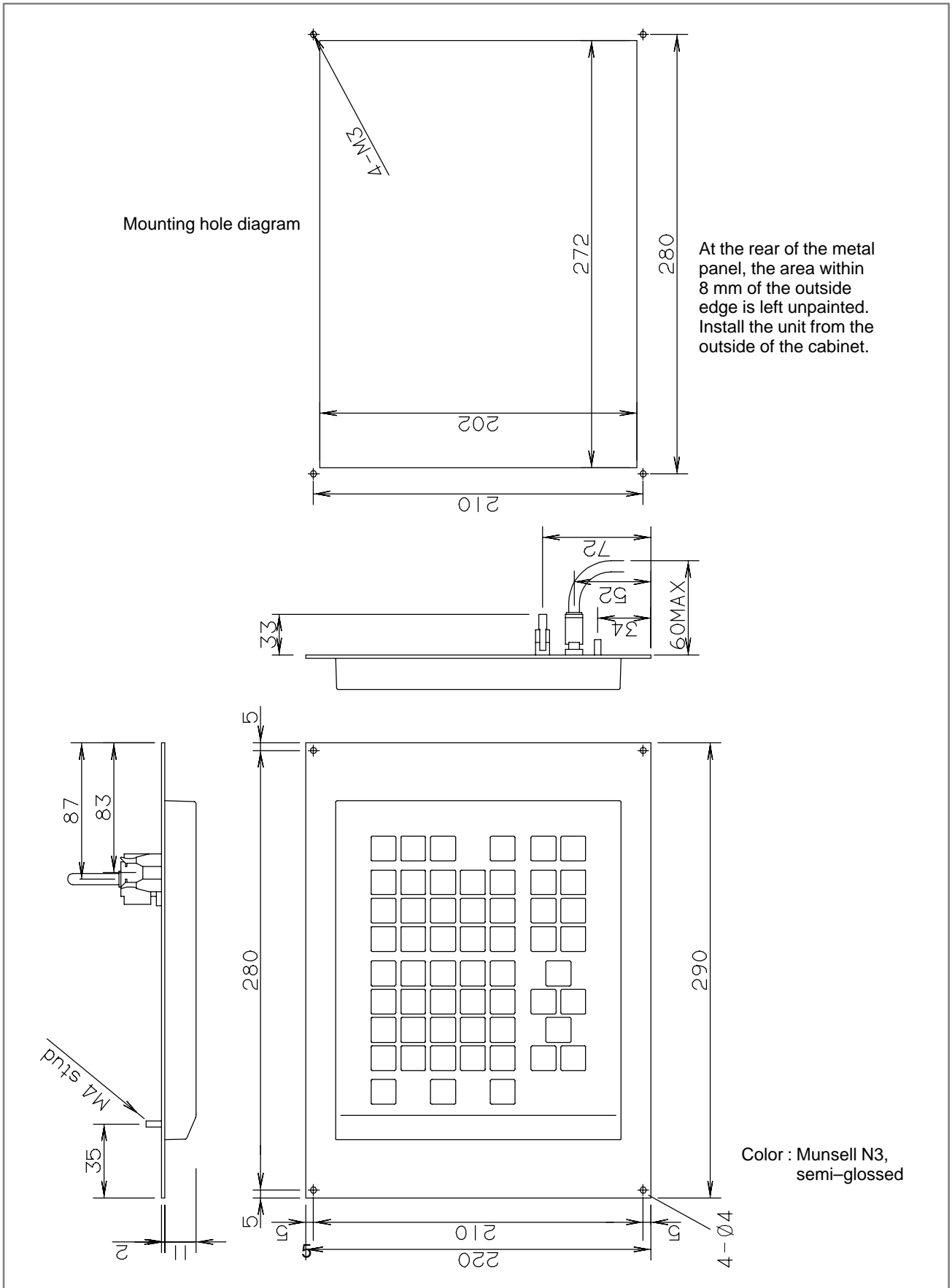

Fig. U16 External dimensions of stand-alone type standard MDI unit (vertical type)

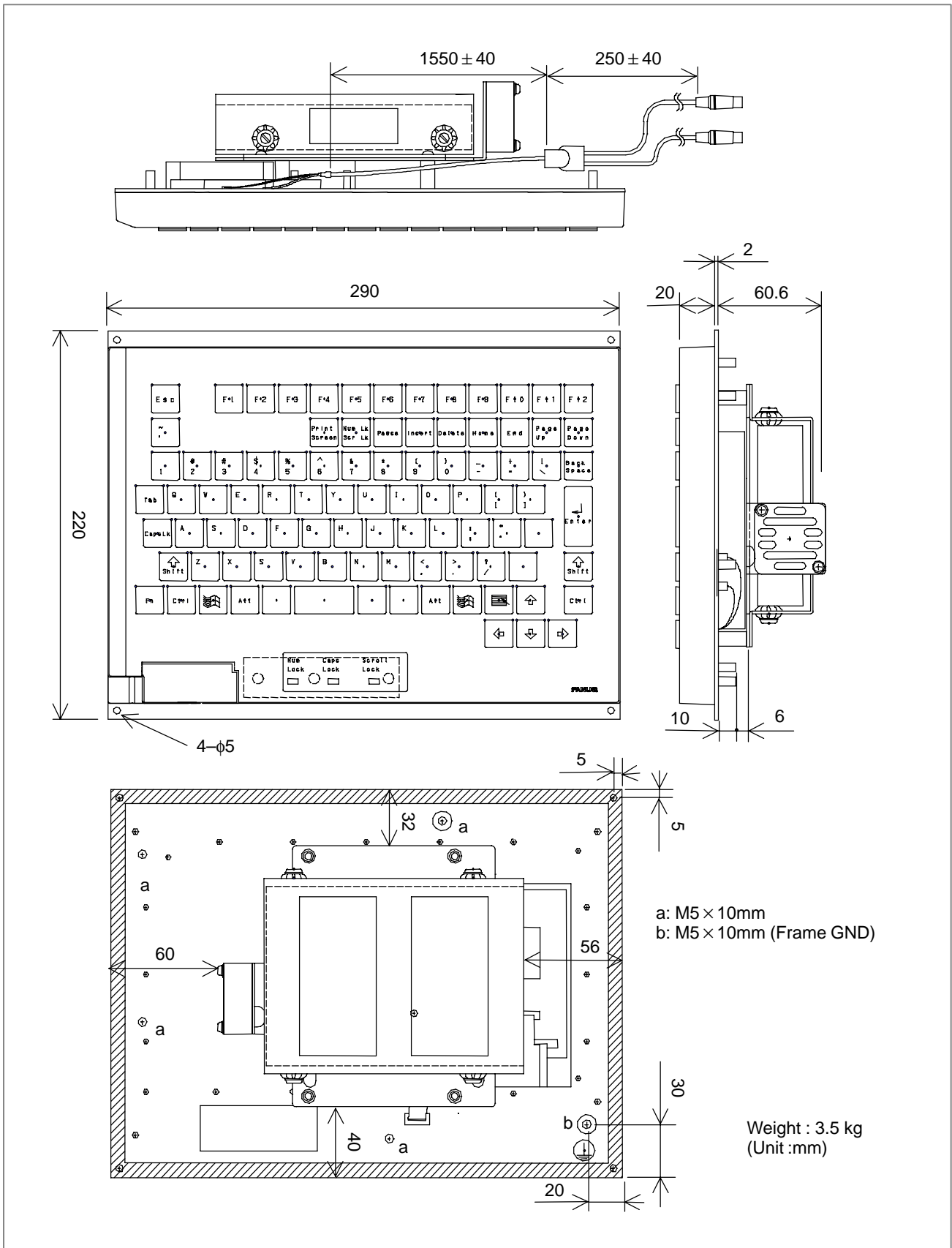

Fig. U17 (a) FA Full Keyboard 10.4" LCD Type (Specification: A02B-0236-C131#JC,A02B-0236-C131#EC)

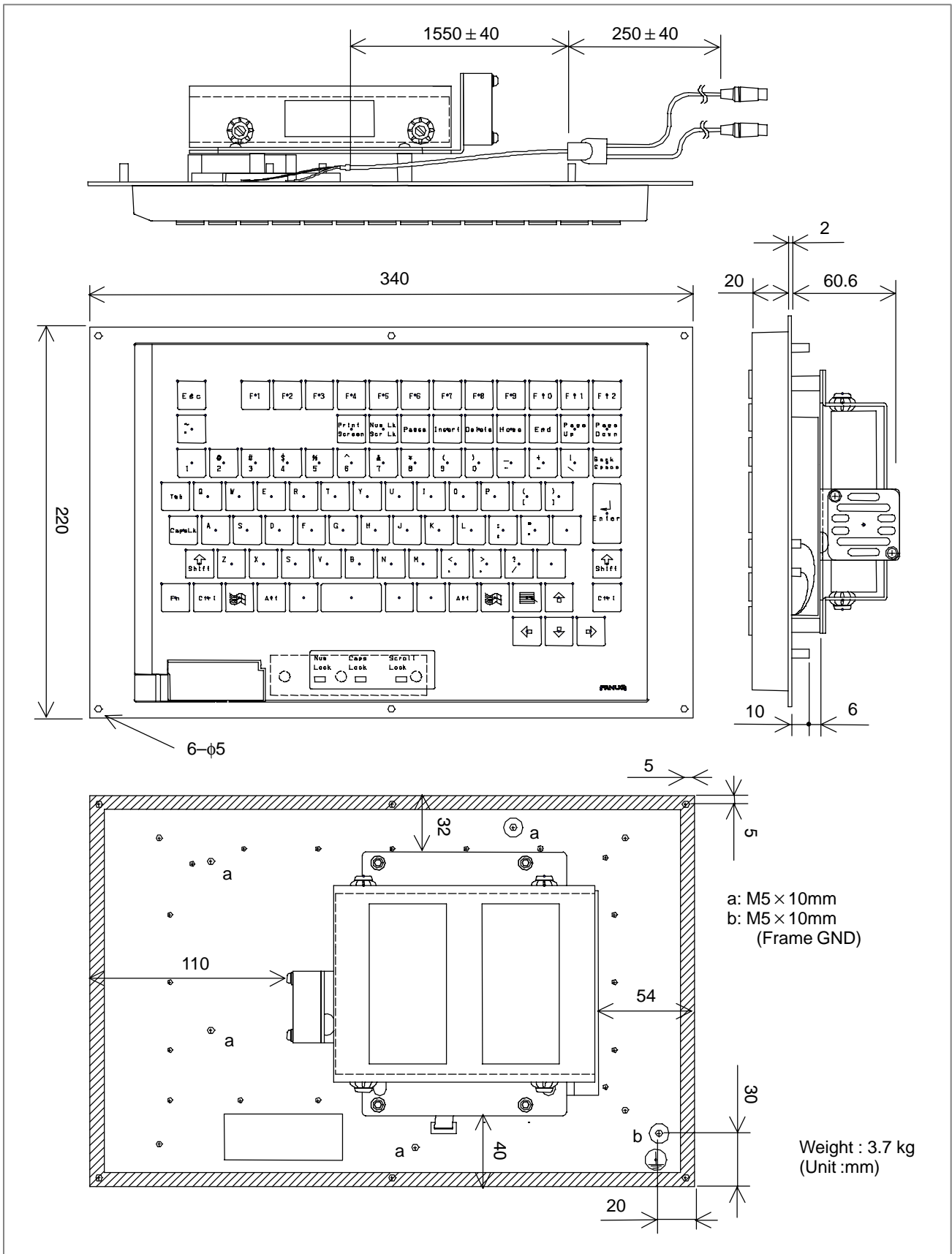

Fig. U17 (b) FA Full Keyboard 12.1" LCD Type (Specification: A02B-0236-C132#JC,A02B-0236-C132#EC)

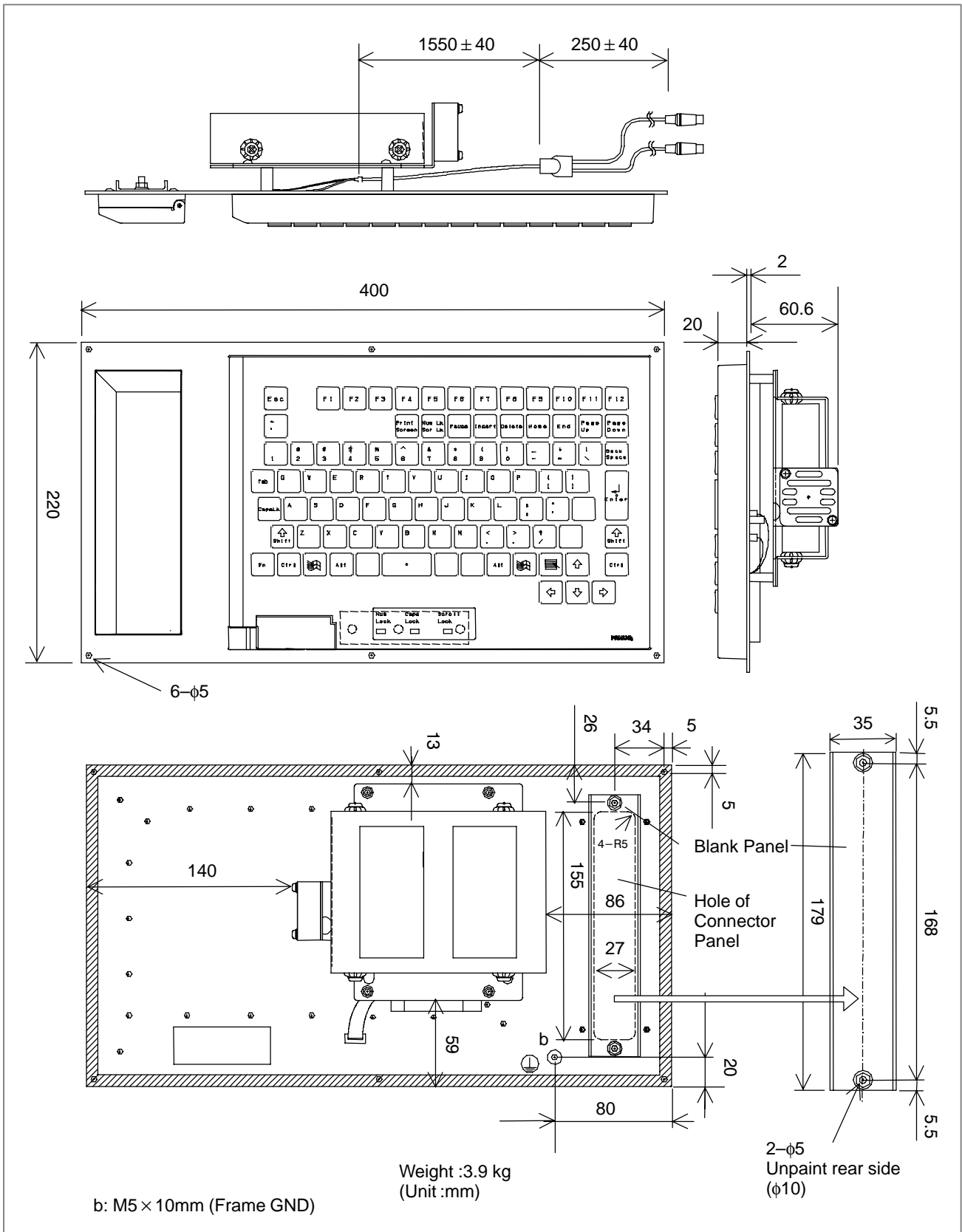

Fig. U17 (c) FA Full Keyboard 15.0" LCD Type (Specification: A08B-0082-C150#JC, A08B-0082-C150#EC)

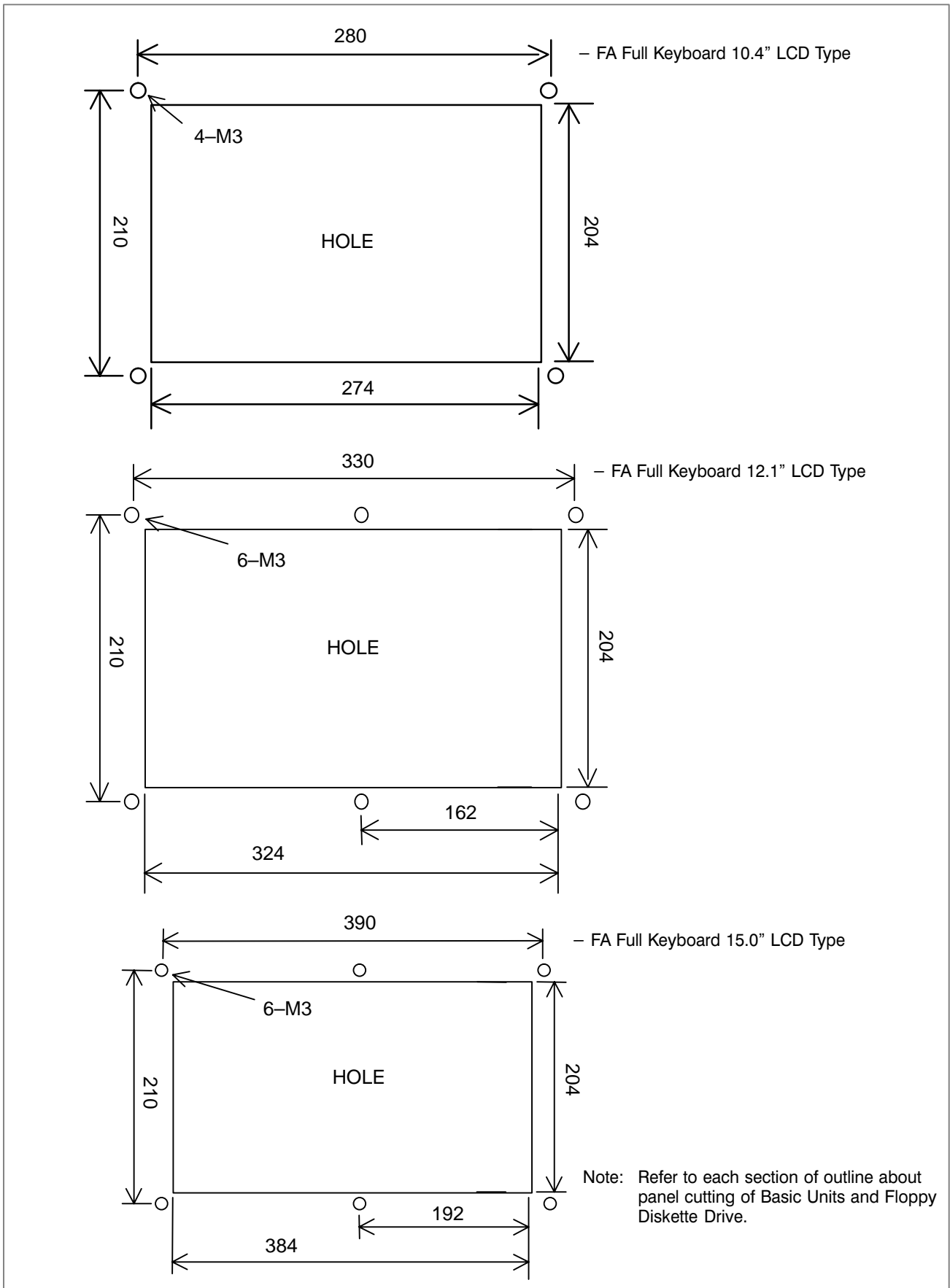
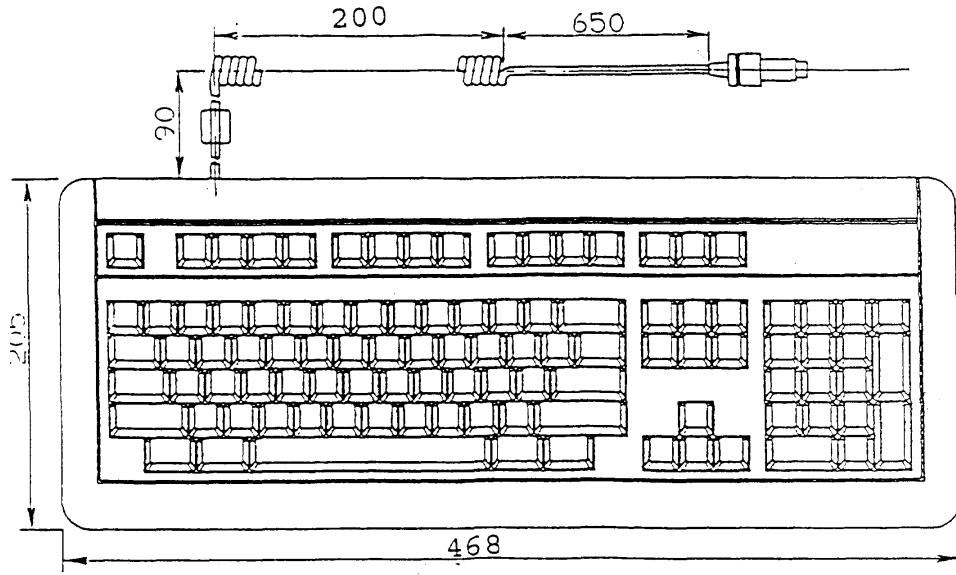
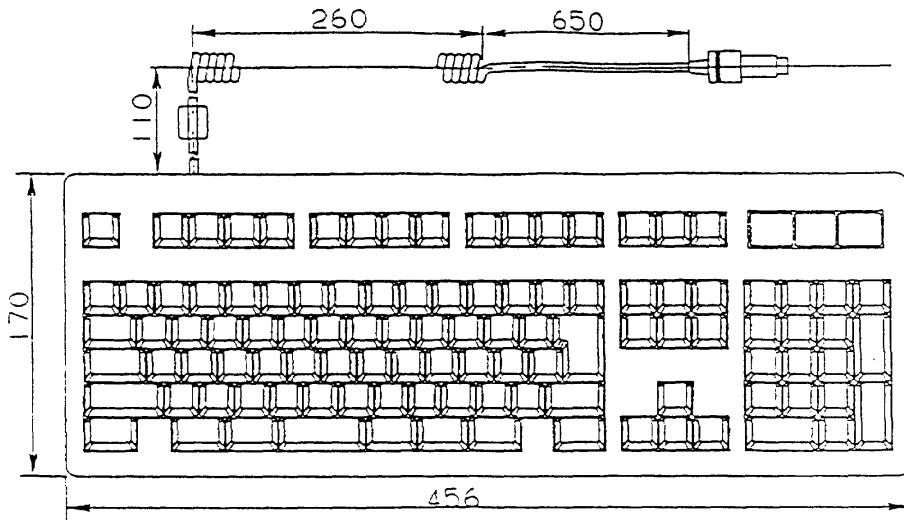

Fig. U17 (d) Panel Cutting



Full Keyboard 101 key (A86L-0001-0210)

(Unit : mm)



Full Keyboard 106key (A86L-0001-0211)

(Unit : mm)

Note: These units can be used only during application development and maintenance ,and this is not dust proof. .Ambient temperature during operation is 0°C-40°C.

Fig. U18 Full Keyboard 101/106key

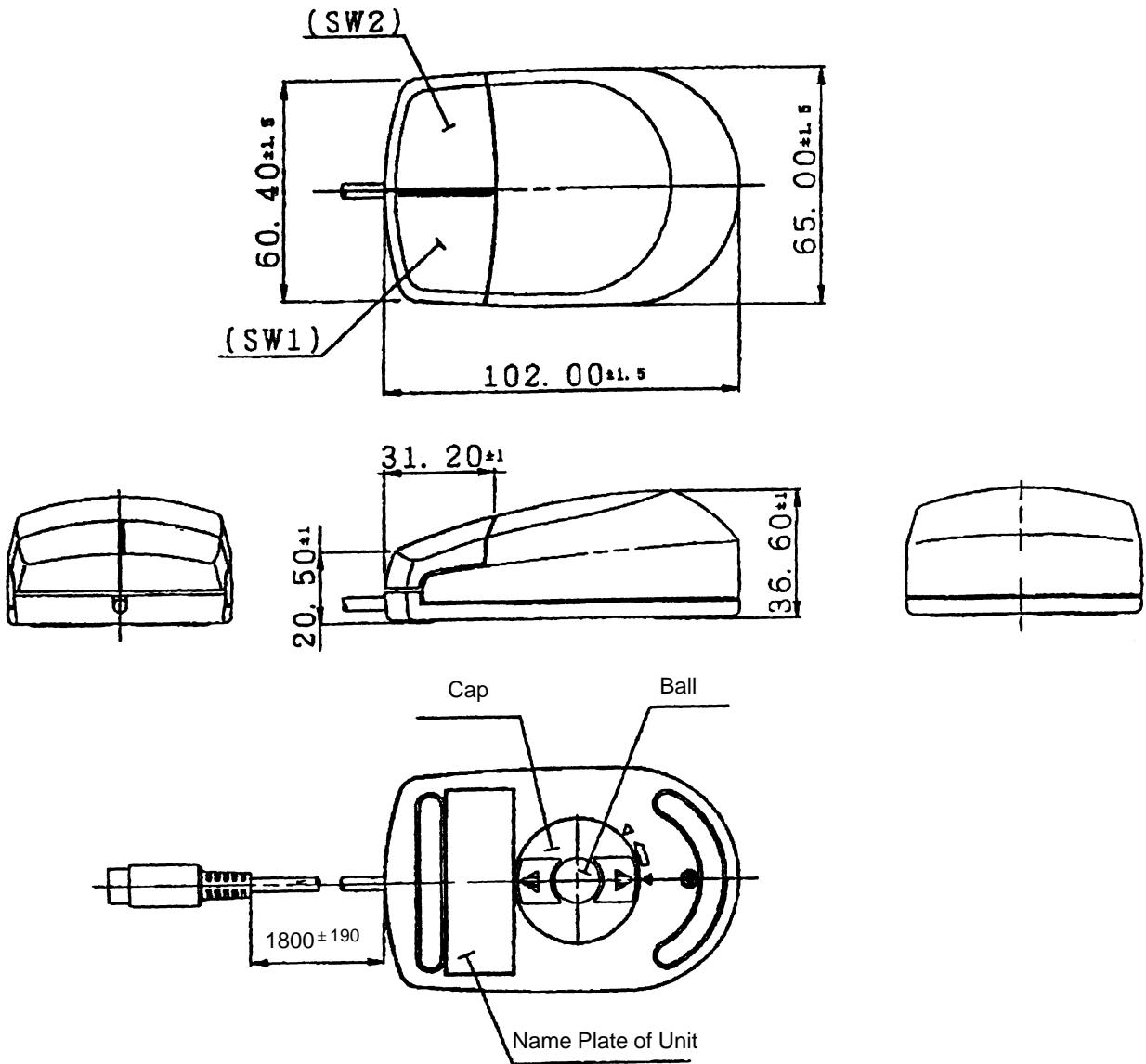

(Unit : mm)

Note: This unit can be used only during application development and maintenance ,and this is not dust proof. .Ambient temperature during operation is 0°C - 40°C .

Fig. U19 Mouse (Specification: A86L-0001-0212)

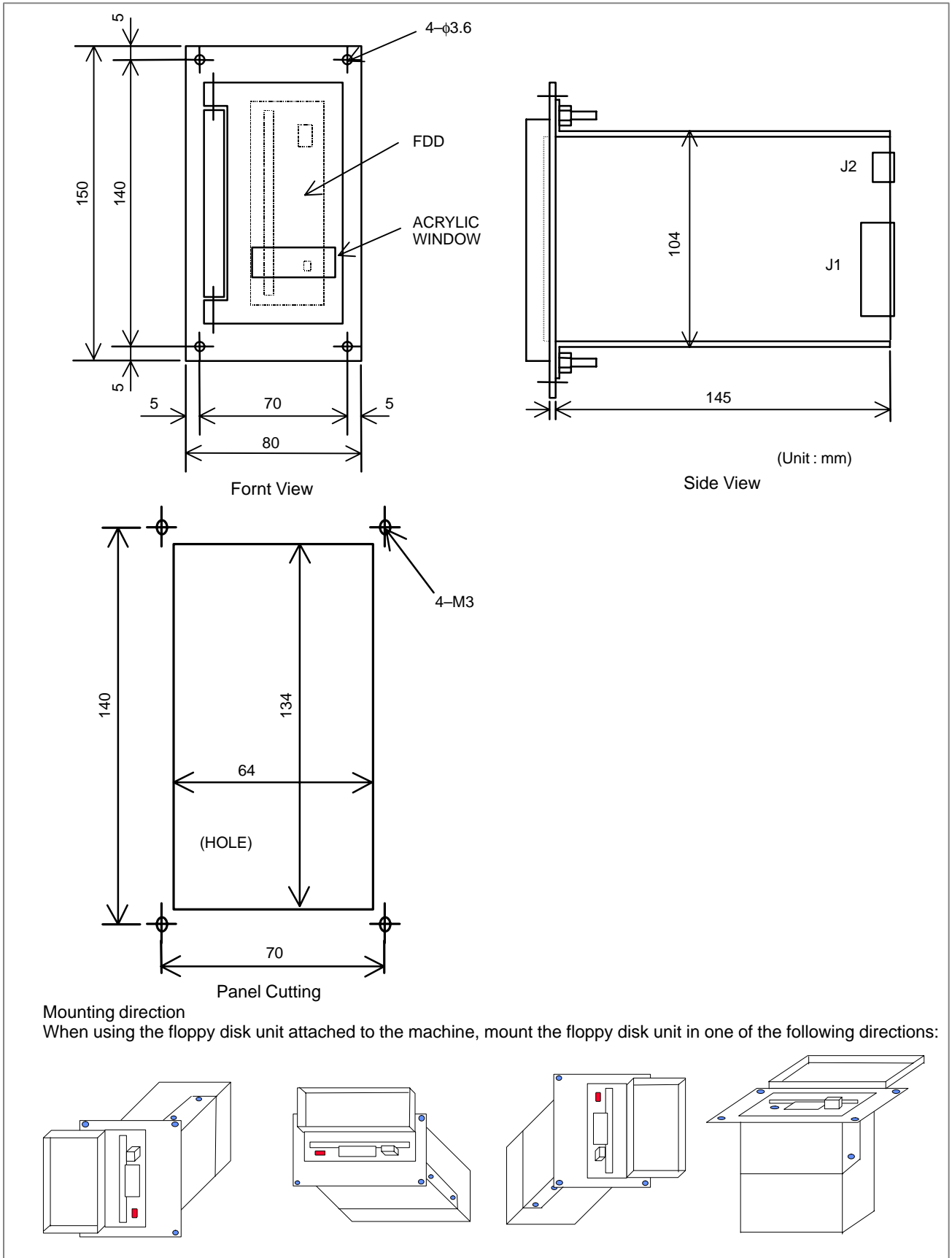

Fig. U20 Floppy disk unit
Specification No.: A20B-0207-C008

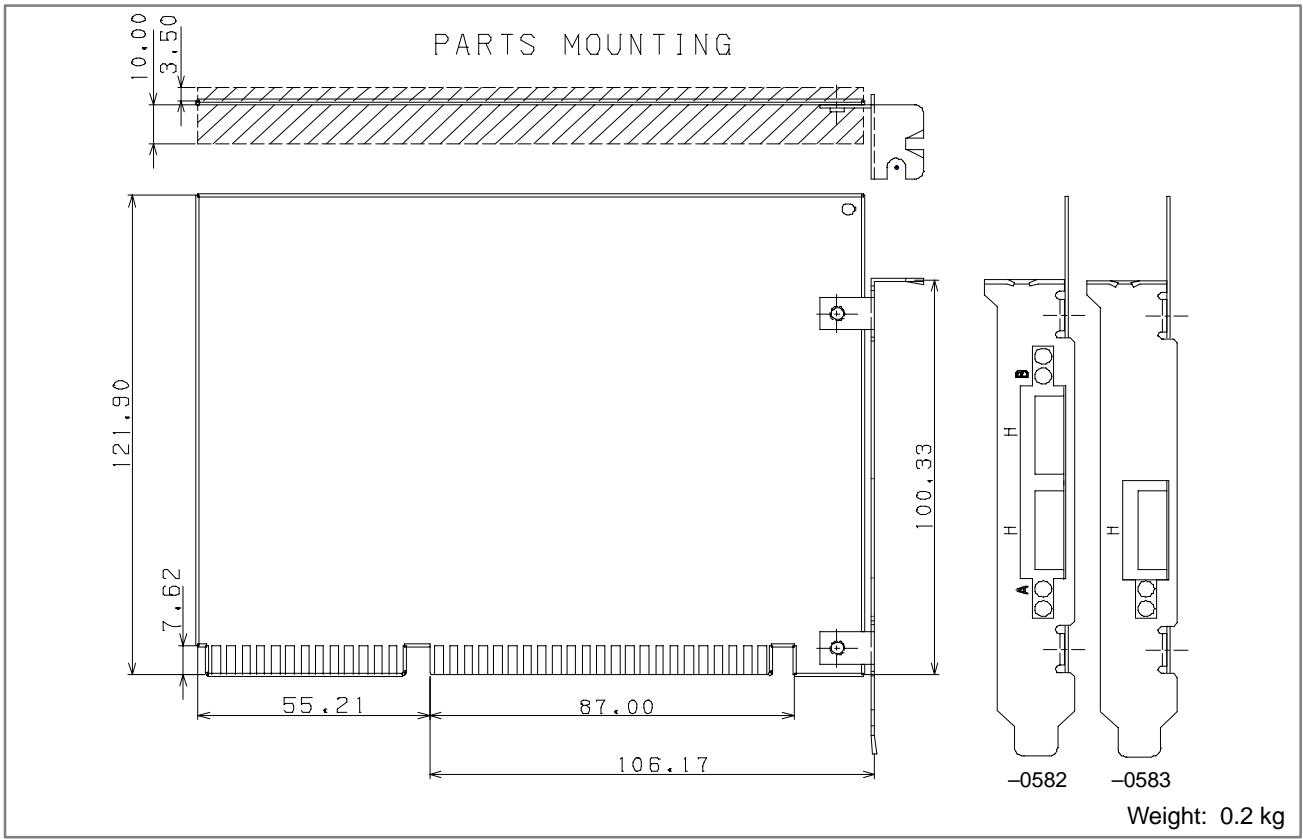

Fig. U21 (a) High-speed serial bus interface board type 2 (PC) (ISA bus version)
Specification No.: A20B-8001-0583 (1 CH)
A20B-8001-0582 (2 CH)

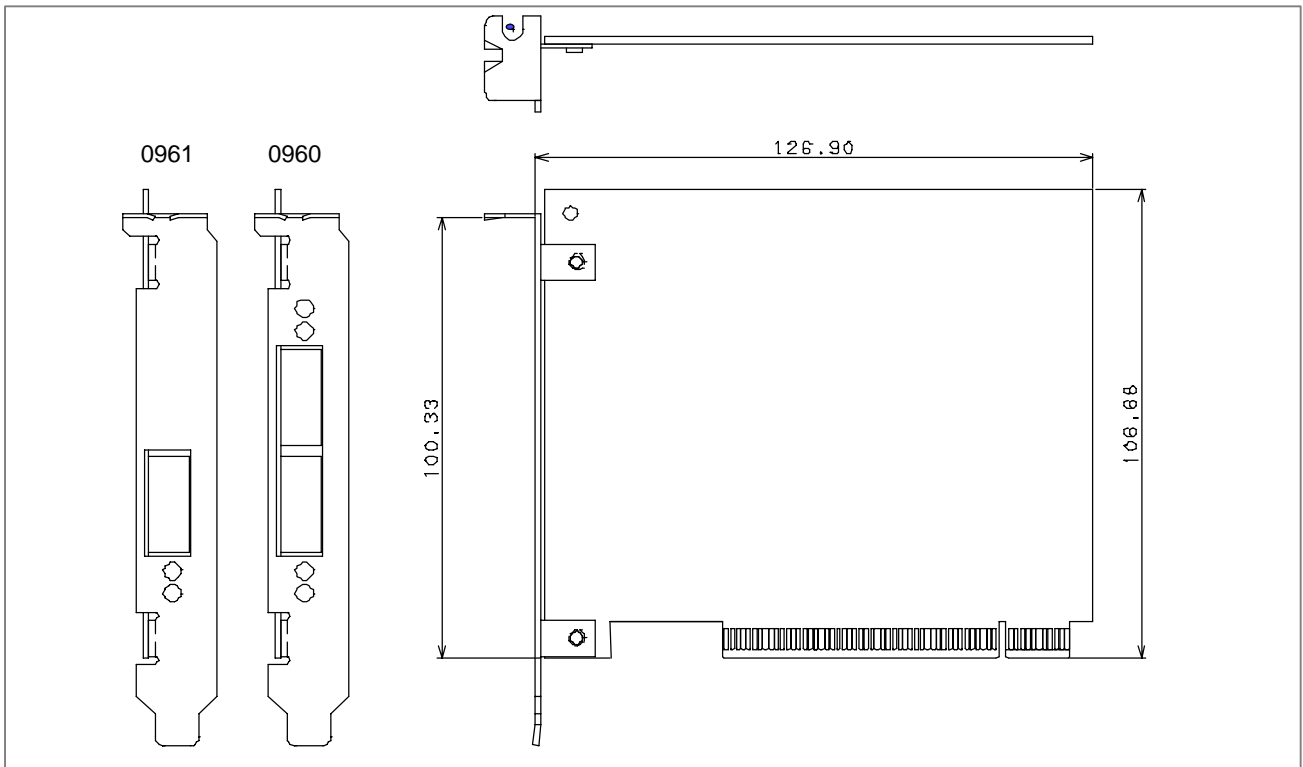

Fig. U21 (b) Interface Board for Personal Computer (PCI bus version)
Specification No.: A20B-8001-0960 (2 CH)
A20B-8001-0961 (1 CH)

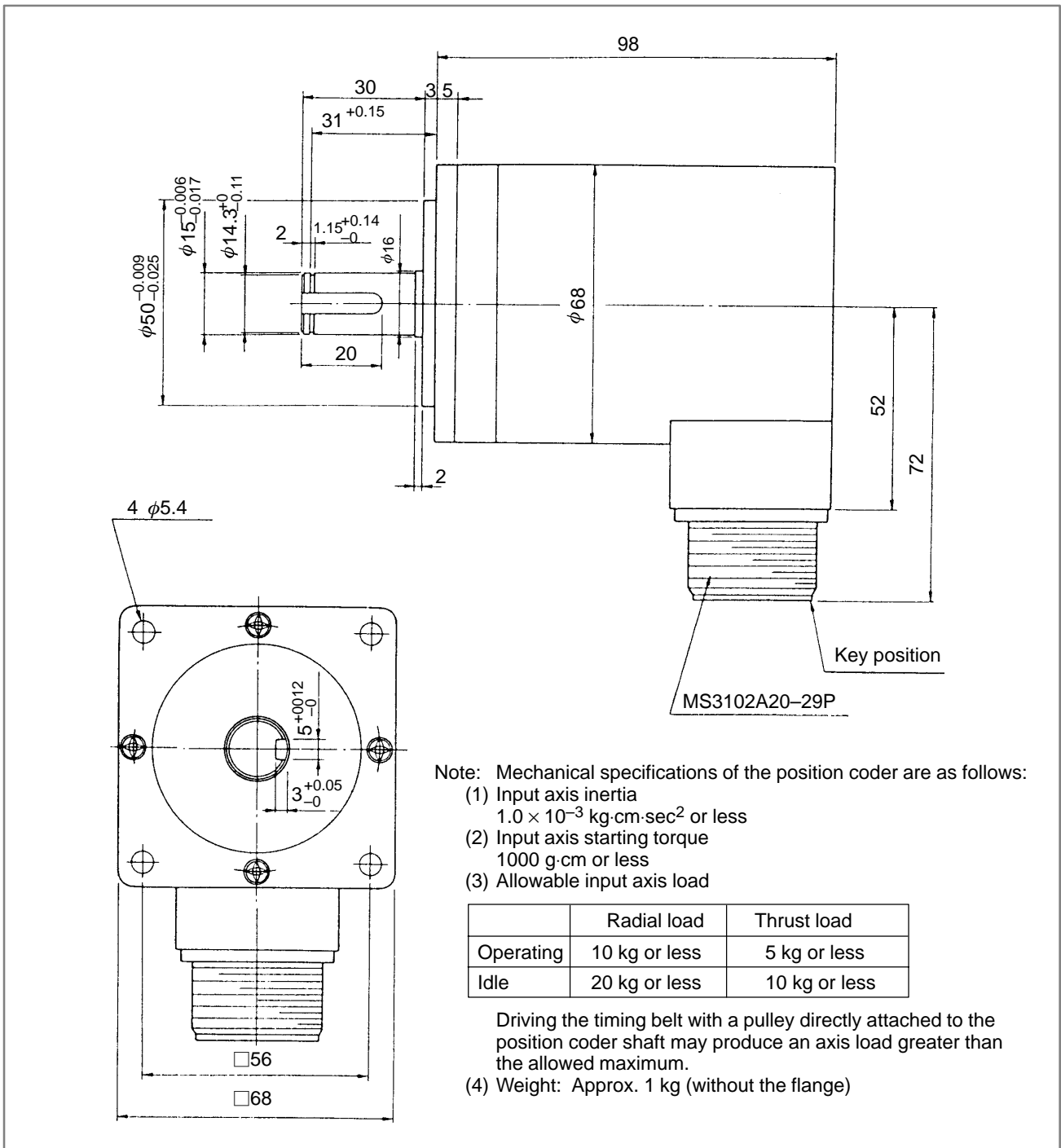

Fig. U22 (a) External dimensions of position coder
Specification No.: A86L-0027-0001#102 (Max. 4000 min⁻¹)
A86L-0027-0001#002 (Max. 6000 min⁻¹)

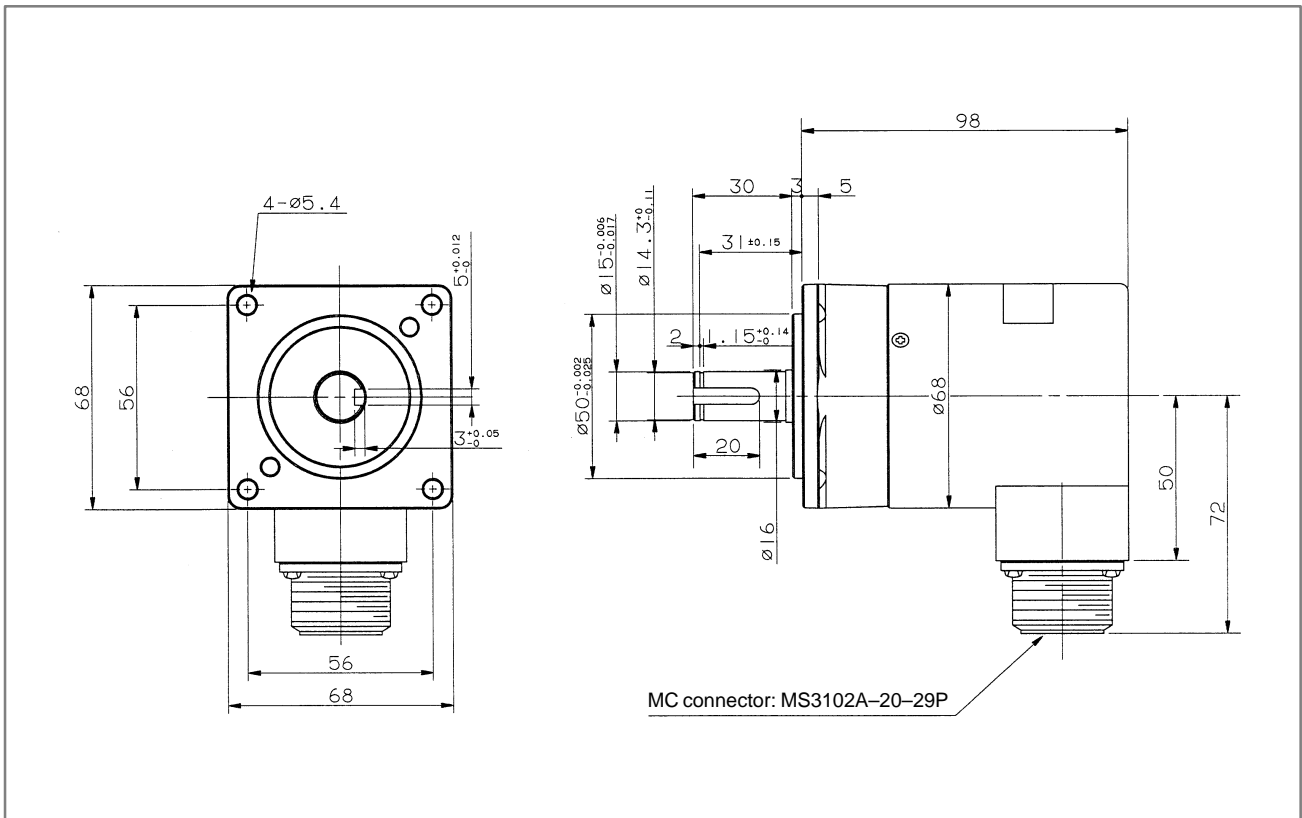

Fig. U22 (b) α position coder
Specification No.: A860-0309-T302 (10000 min⁻¹ maximum)

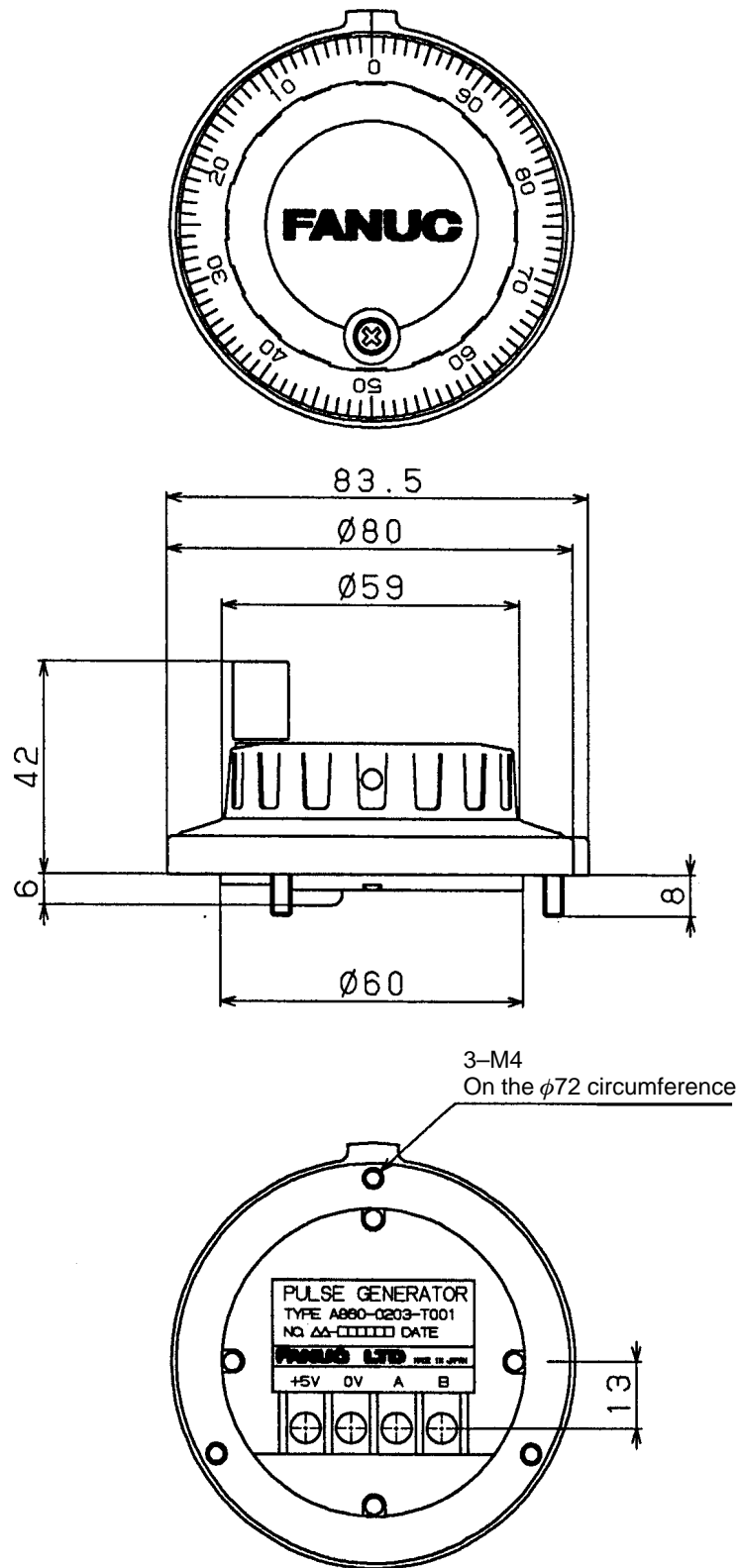

Fig. U23 External dimensions of manual pulse generator
Specification No.: A860-0203-T001

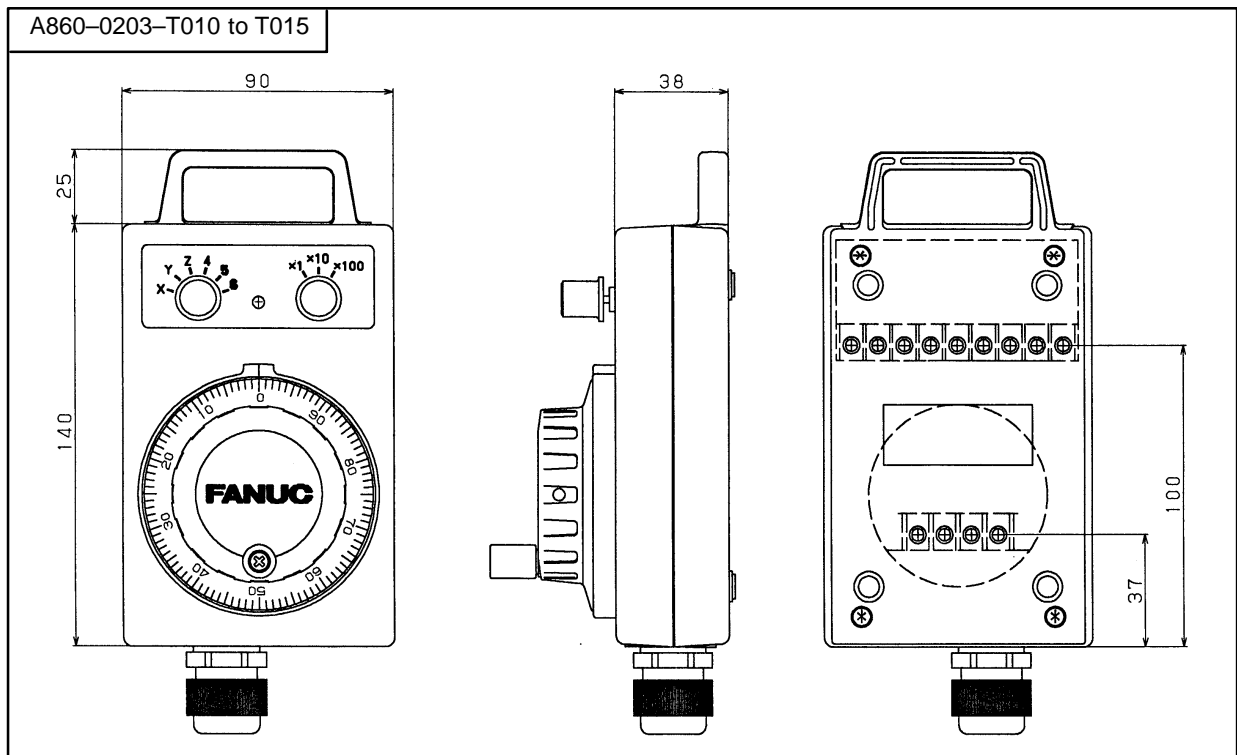

Fig. U24 External dimensions of pendant-type manual pulse generator
Specification No.: A860-0203-T010 to T015

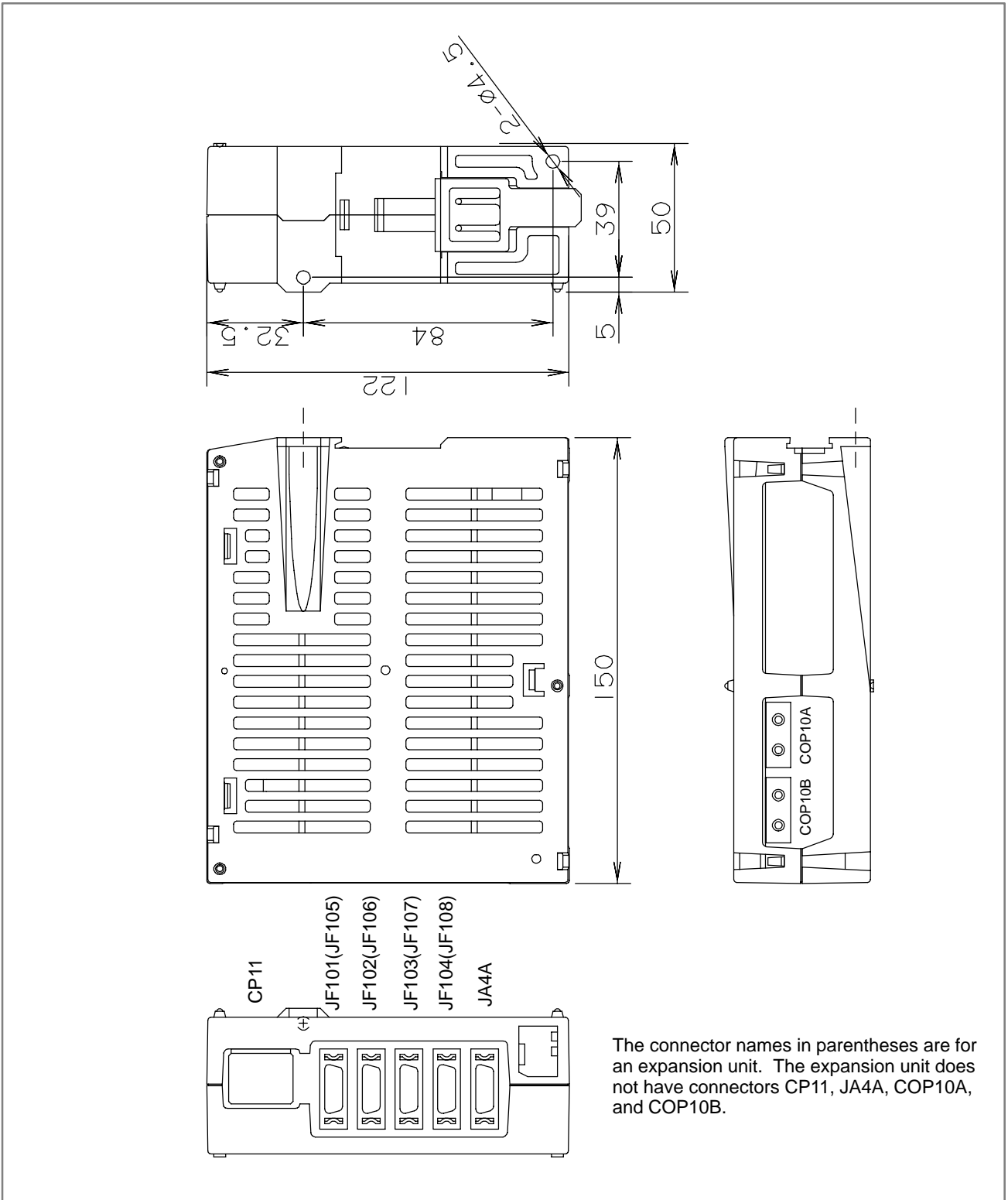

Fig. U25 External dimensions of separate detector interface unit

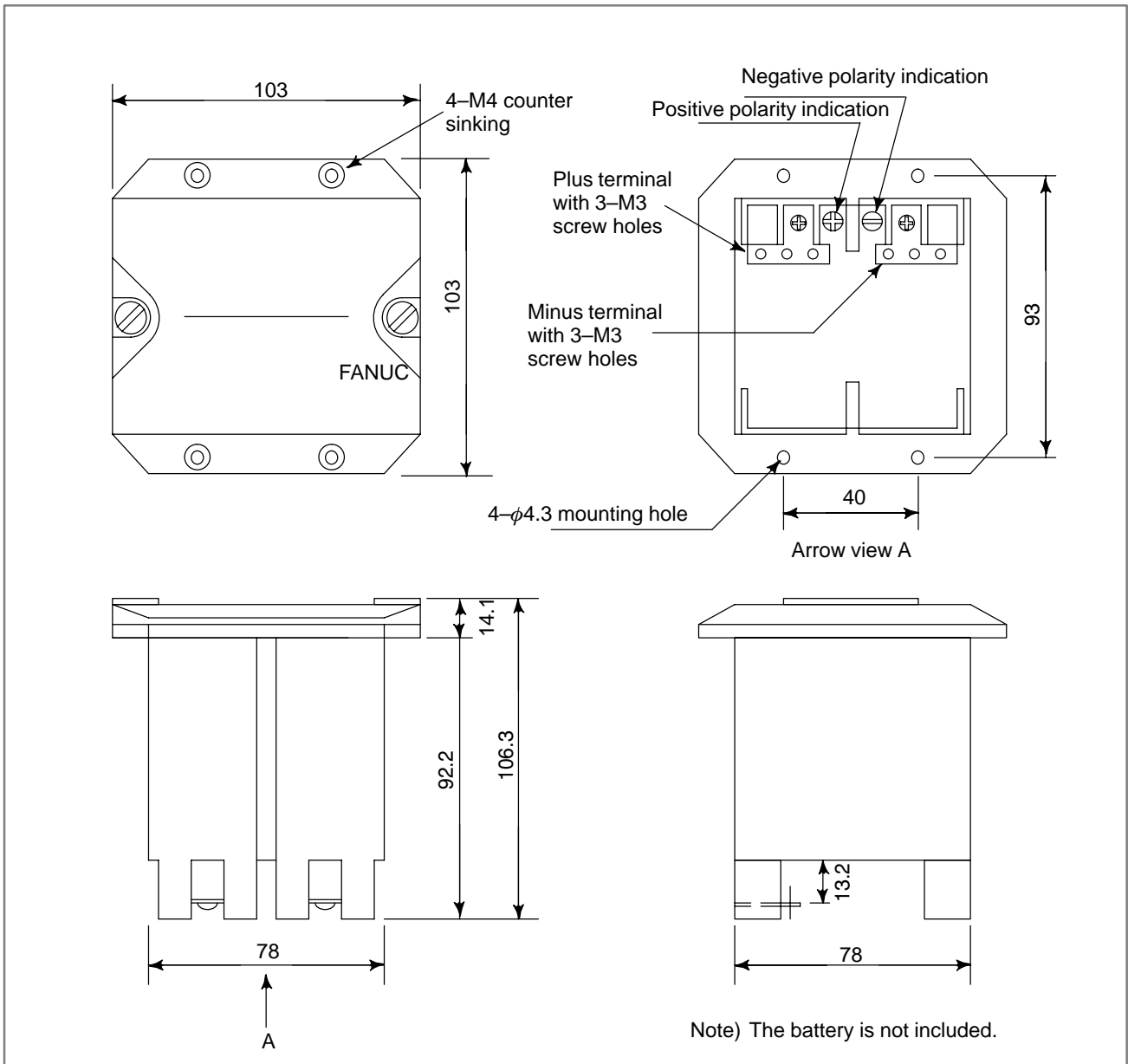

Fig. U26 External dimensions of ABS battery case for separate detector
Specification No.: A06B-6050-K060

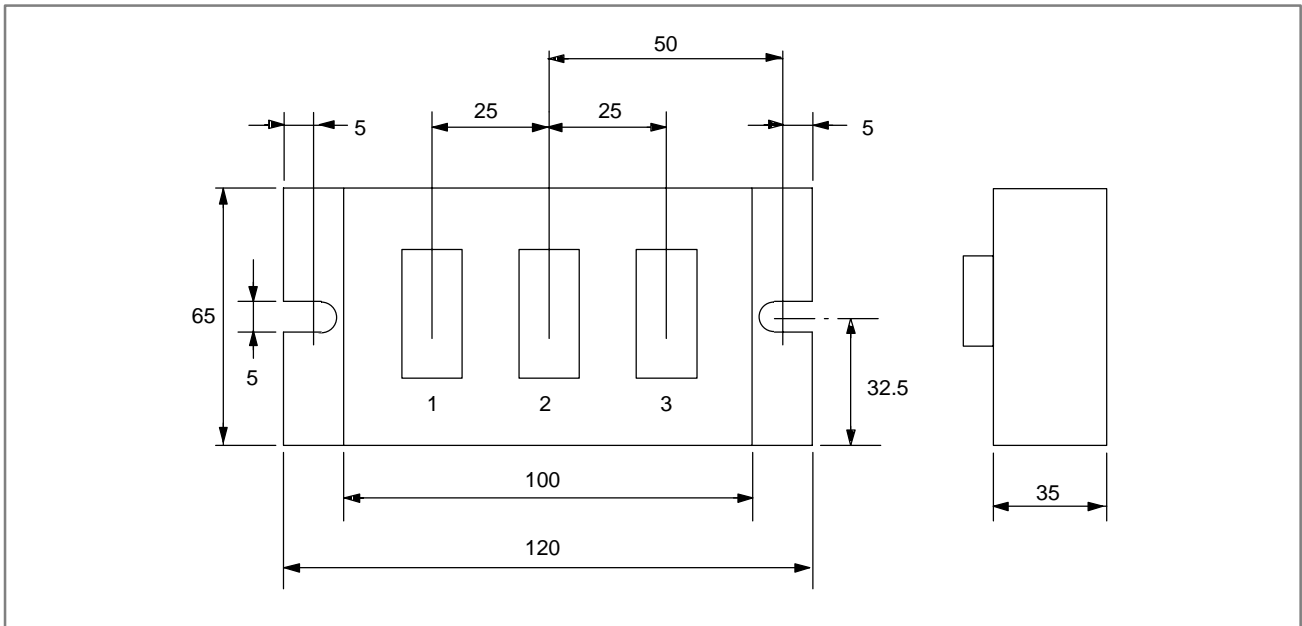

Fig. U27 External dimensions of tap

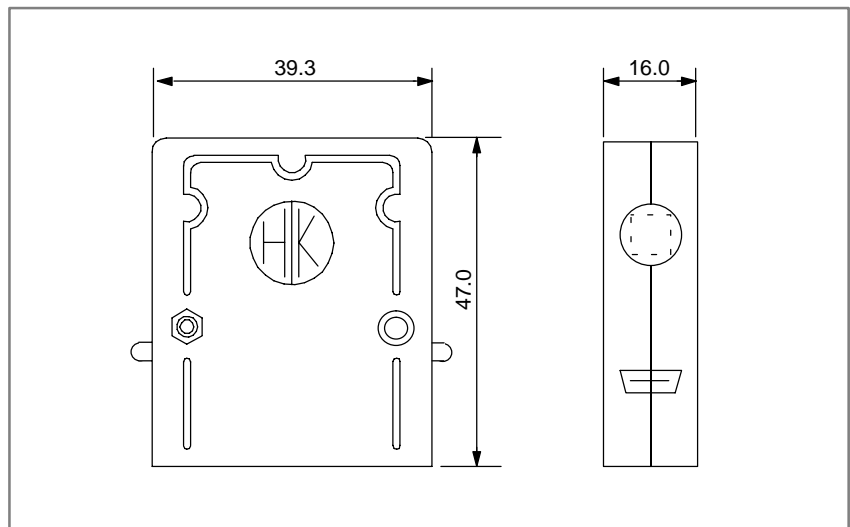

Fig. U28 External dimensions of terminal resistance unit

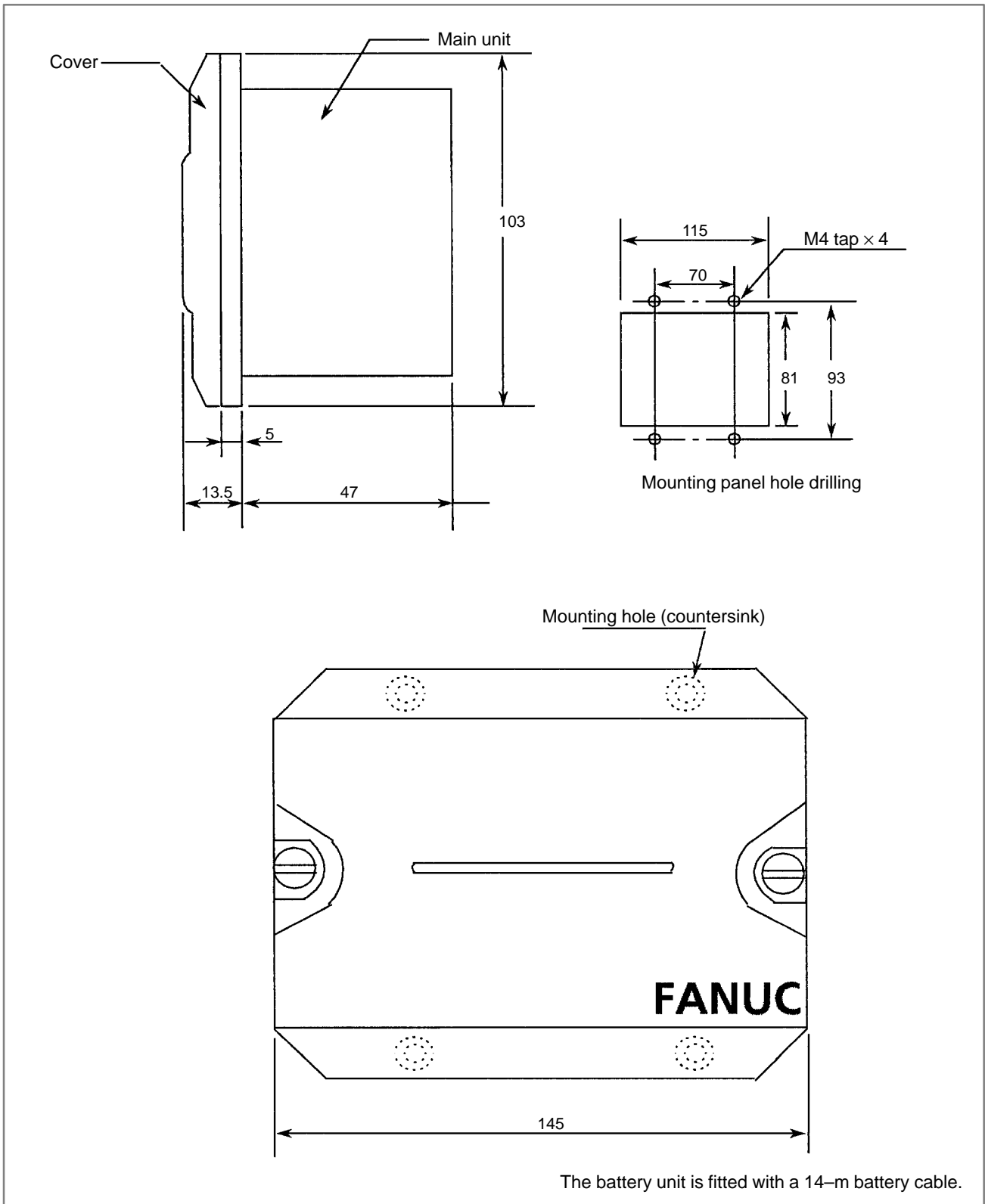

Fig. U29 External dimensions of external CNC battery unit

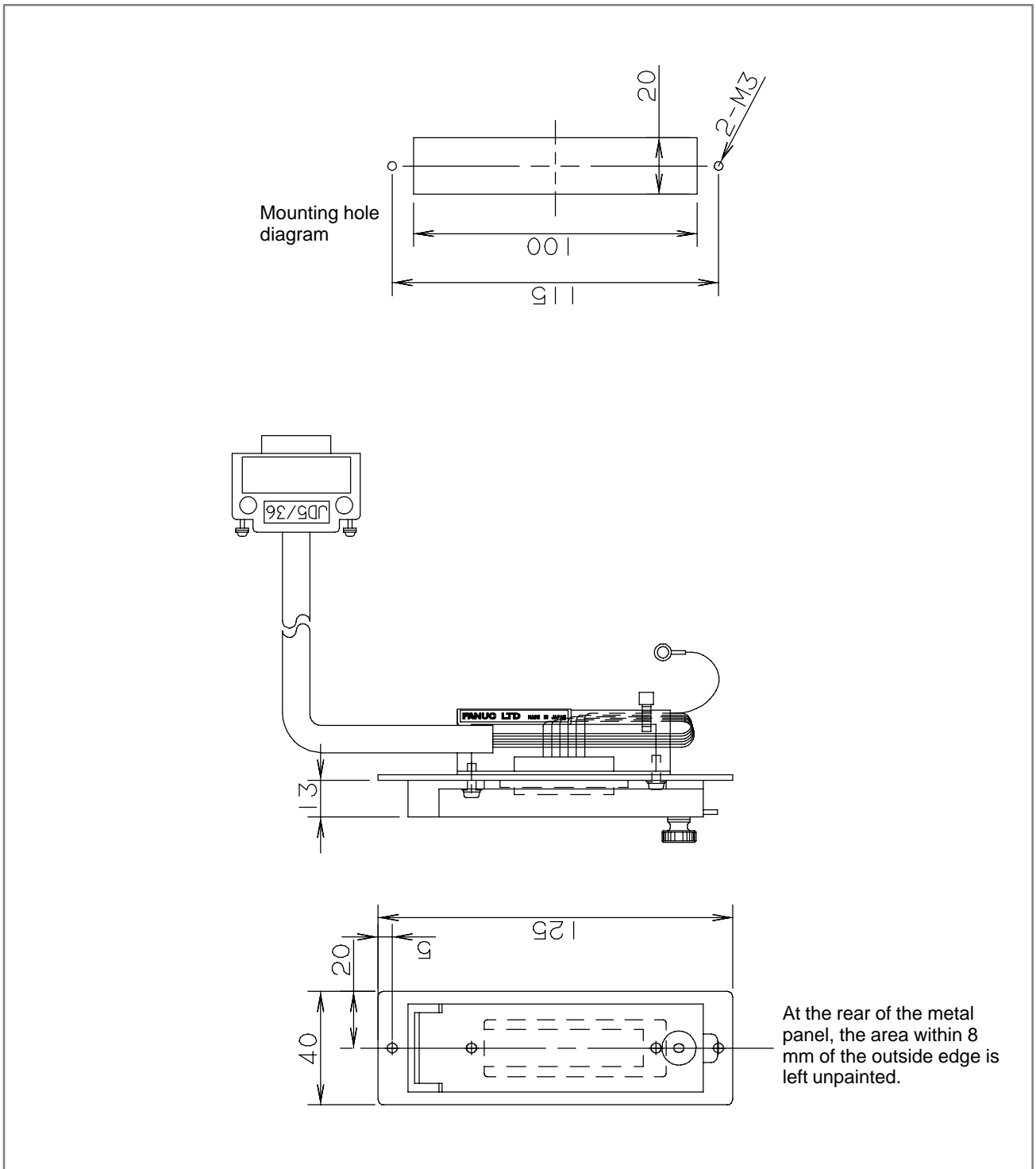
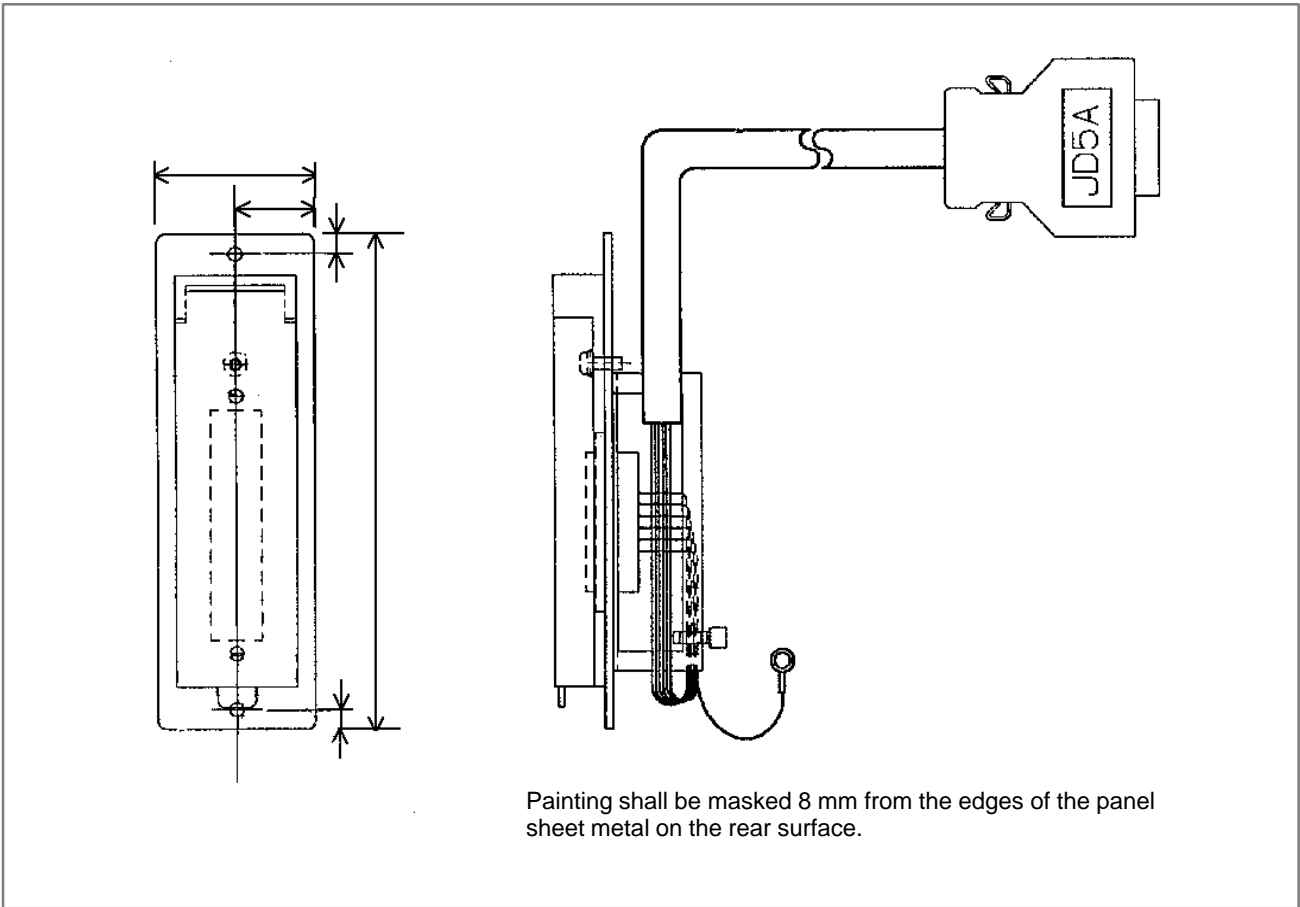

Fig. U30 External dimensions of punch panel (narrow type)



The following is the panel cut layout drawing of this punch panel.

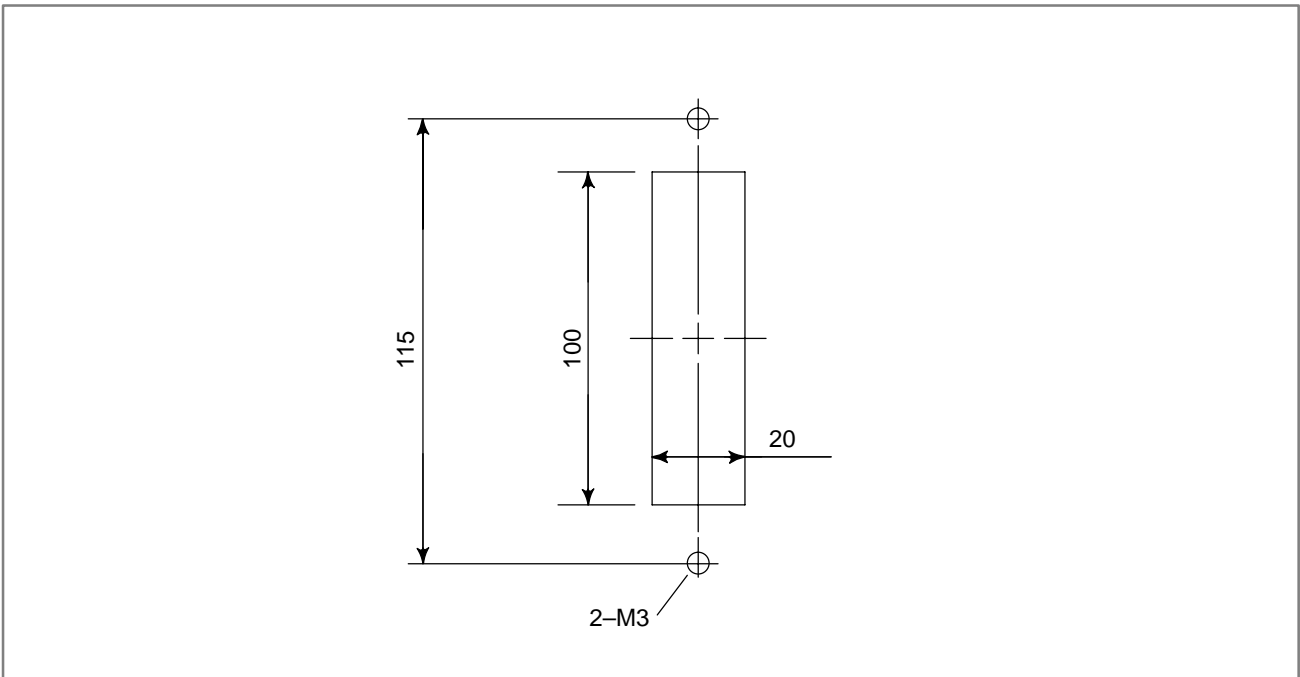

Fig. U31 Punch Panel (Narrow Type)
Specification No.: A02B-0120-C191 (cable length 1 m)
A02B-0120-C192 (cable length 2 m)
A02B-0120-C193 (cable length 5 m)

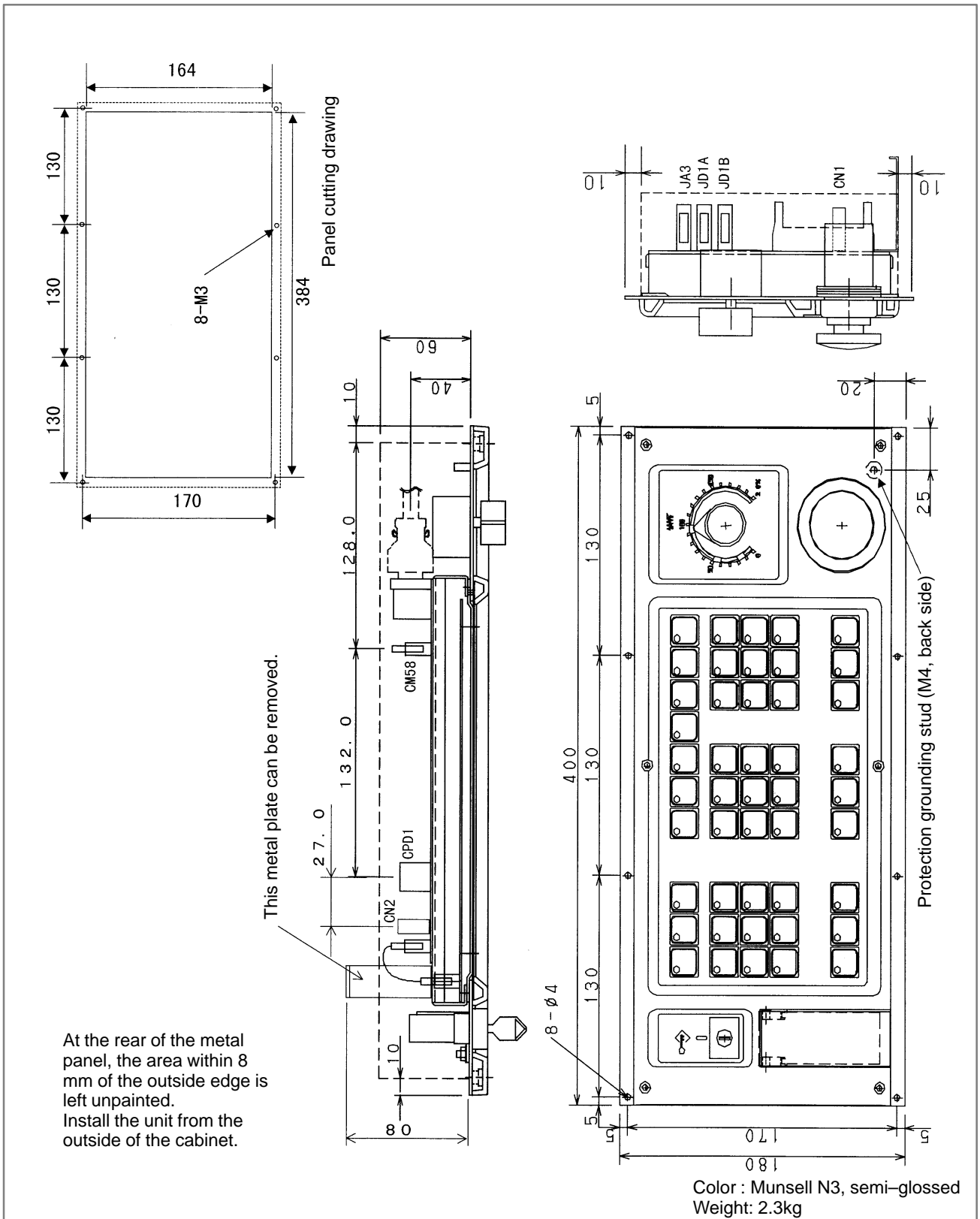

Fig. U32 Distribution I/O small machine operator's panel

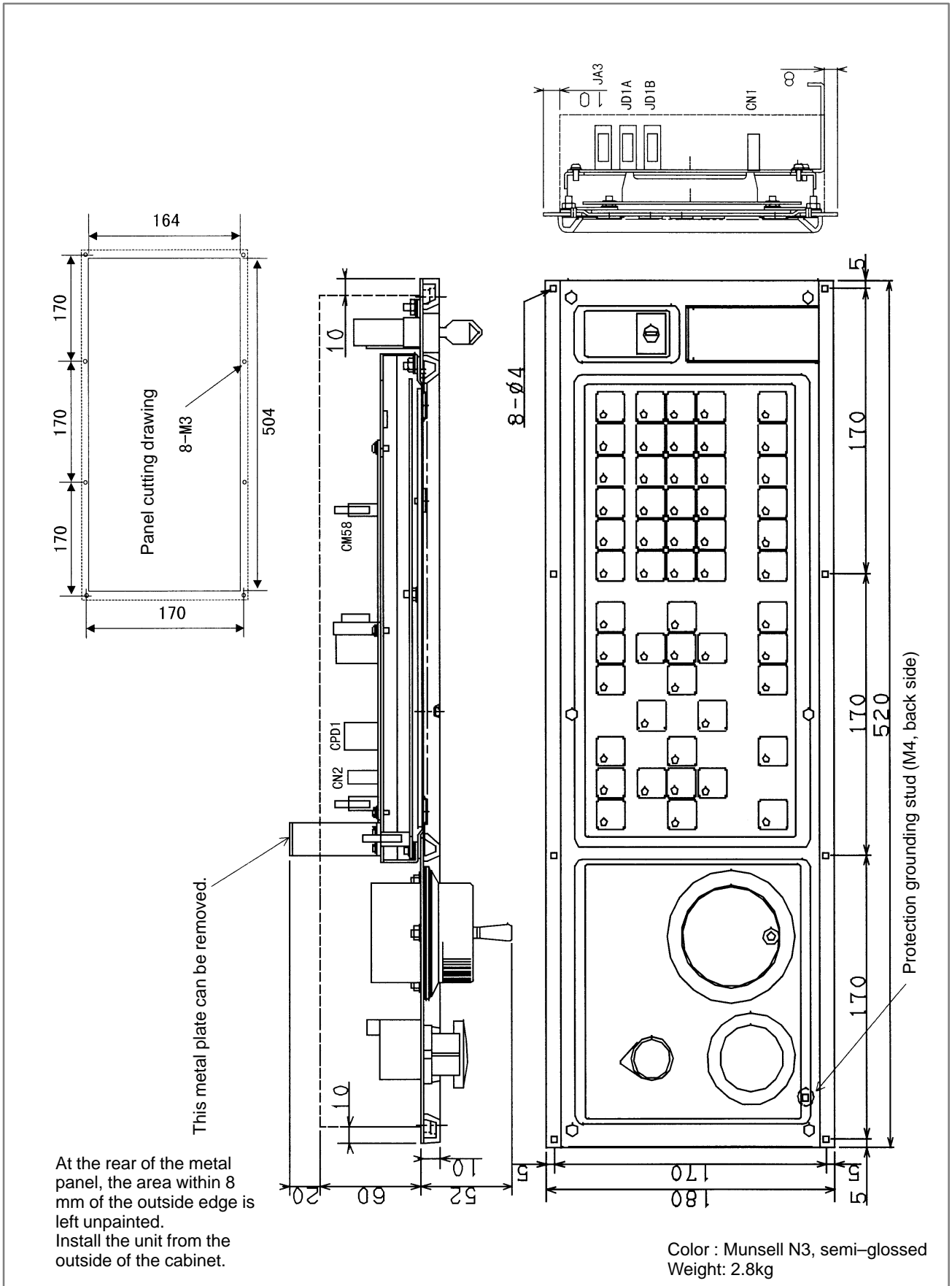
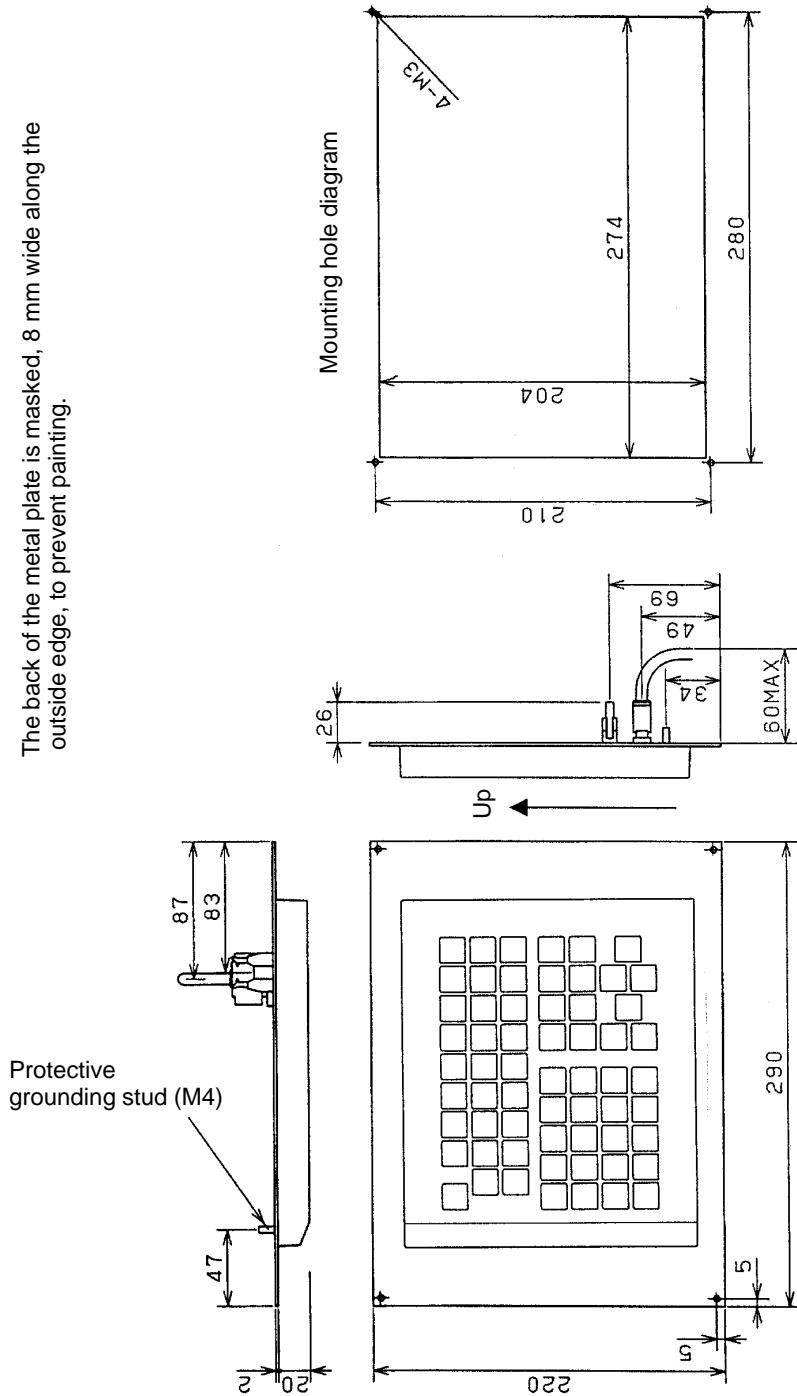

Fig. U33 Distribution I/O standard machine operator's panel

The back of the metal plate is masked, 8 mm wide along the outside edge, to prevent painting.



Weight: 2.0kg

Fig. U34 61-key MDI unit (vertical type)

The back of the metal plate is masked, 8 mm wide along the outside edge, to prevent painting.

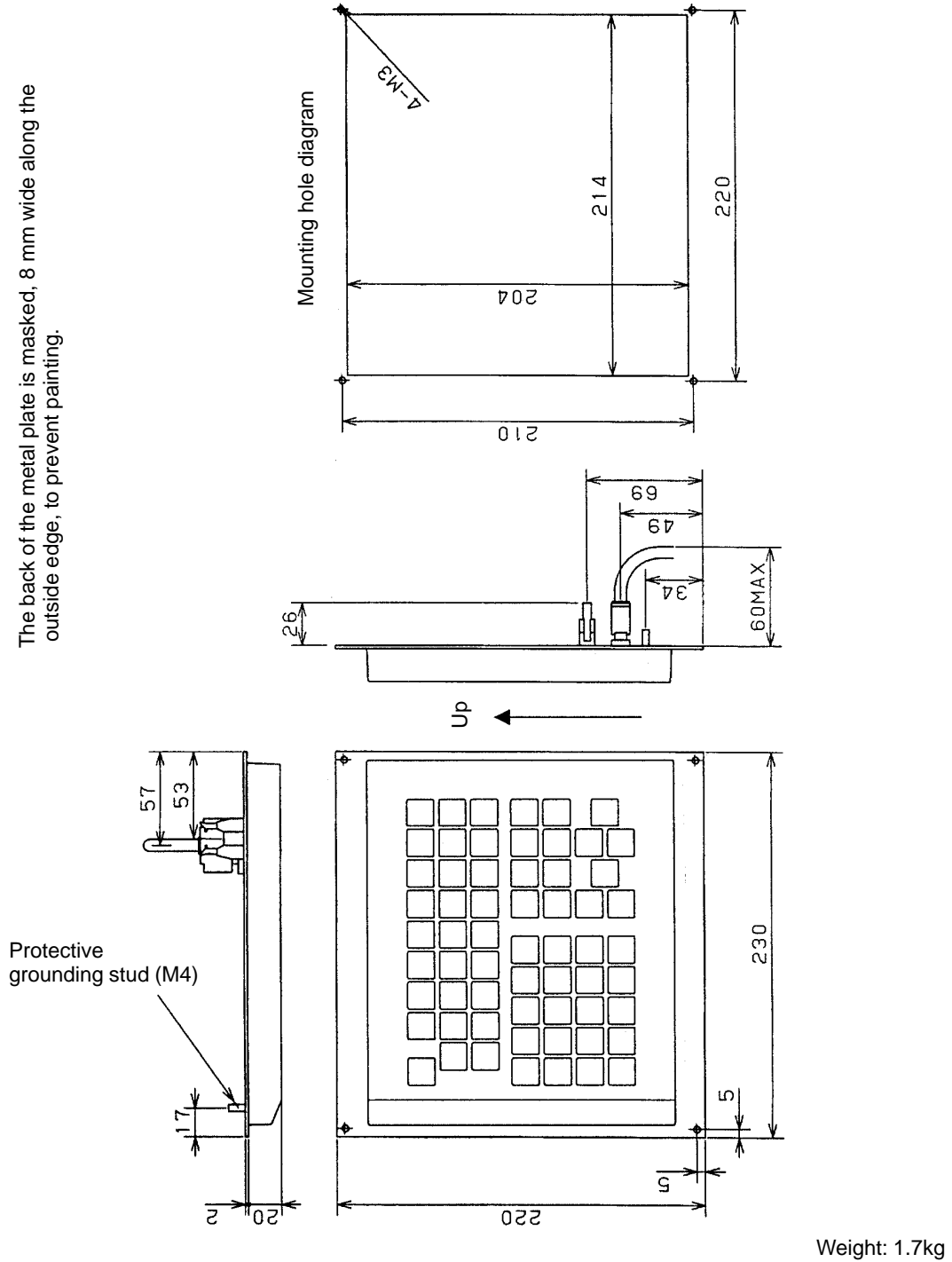

Fig. U35 61-key MDI unit (horizontal type)

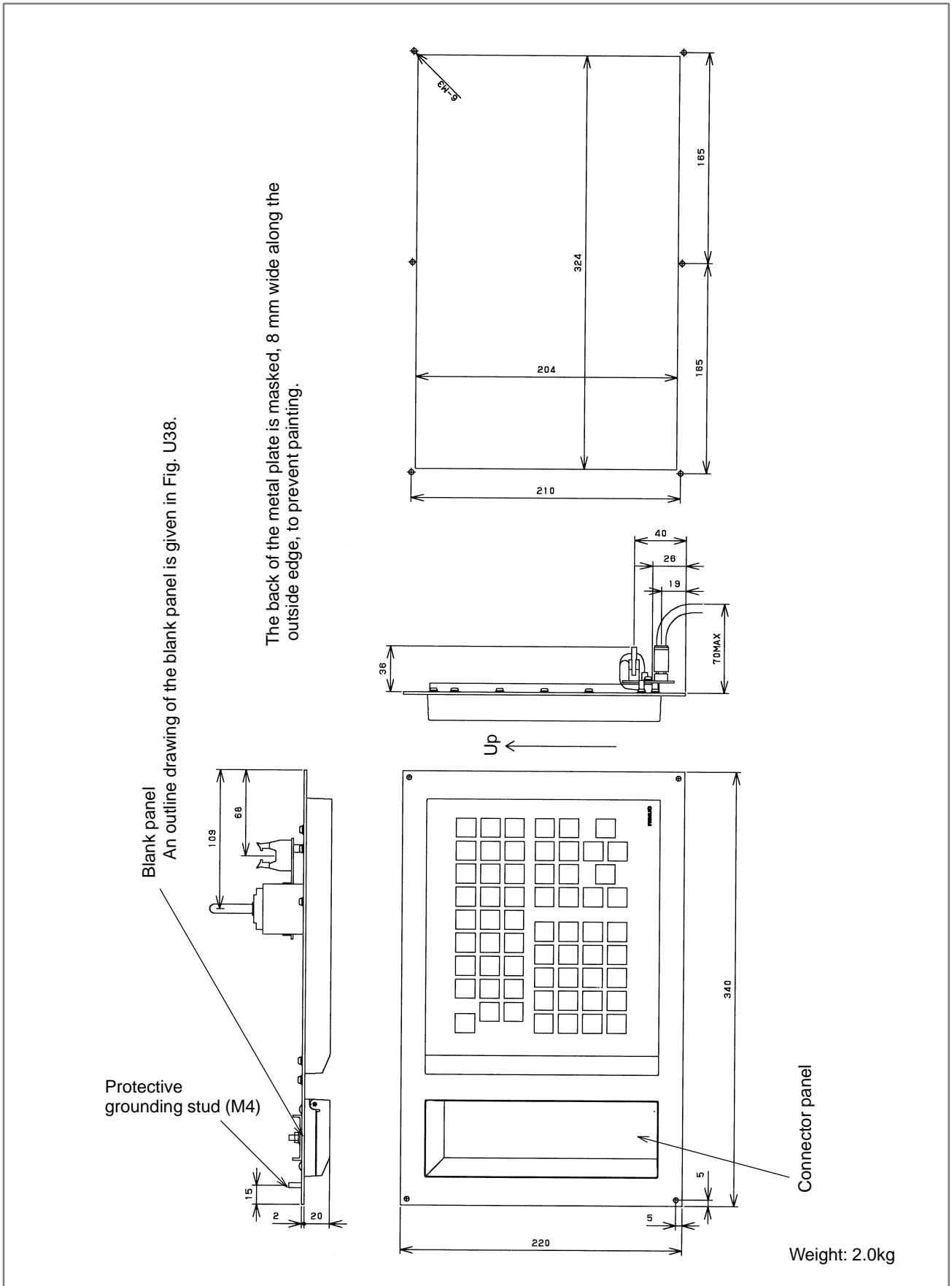

Fig. U36 61-key MDI unit (vertical type)

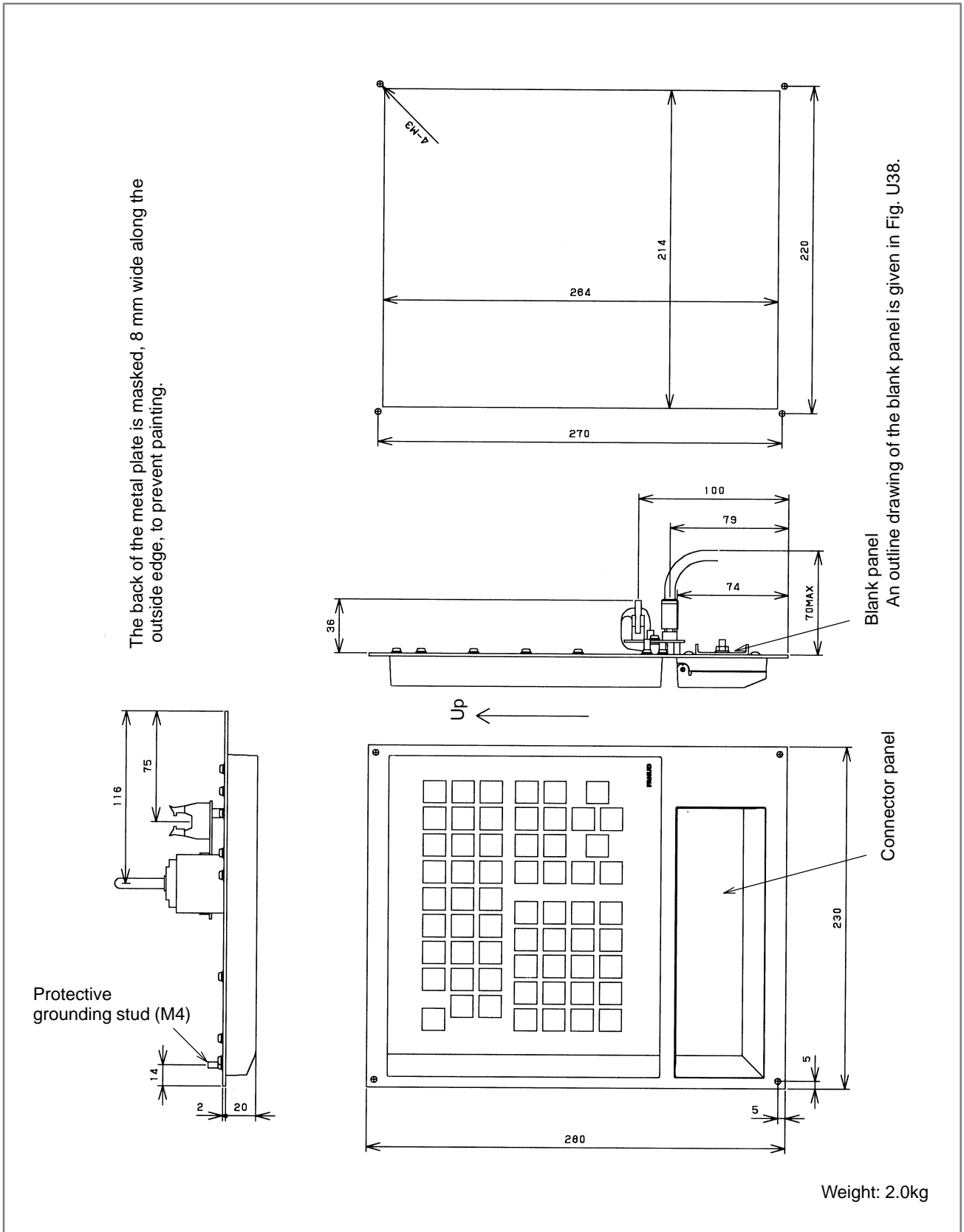

Fig. U37 61-key MDI unit (horizontal type)

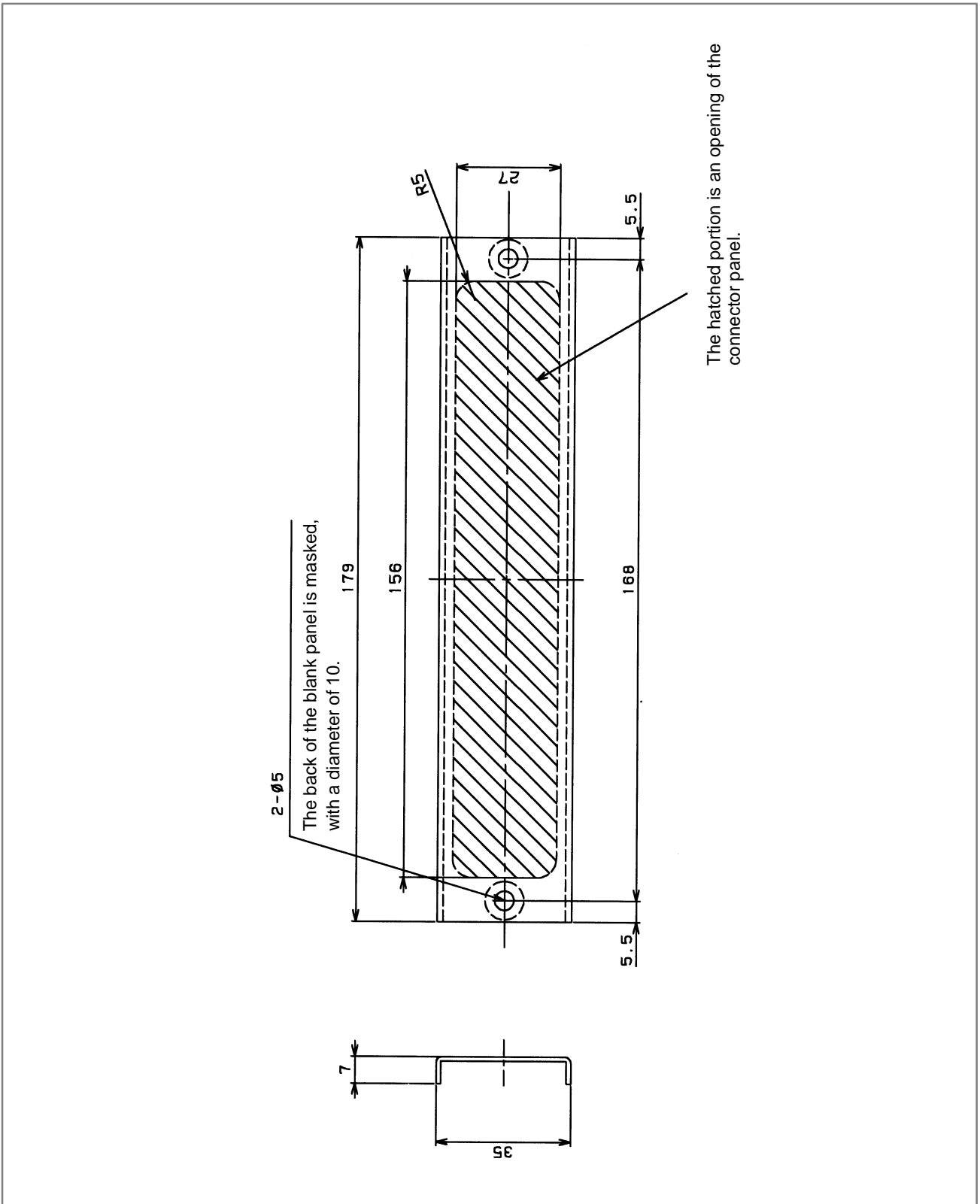

Fig. U38 Blank panel

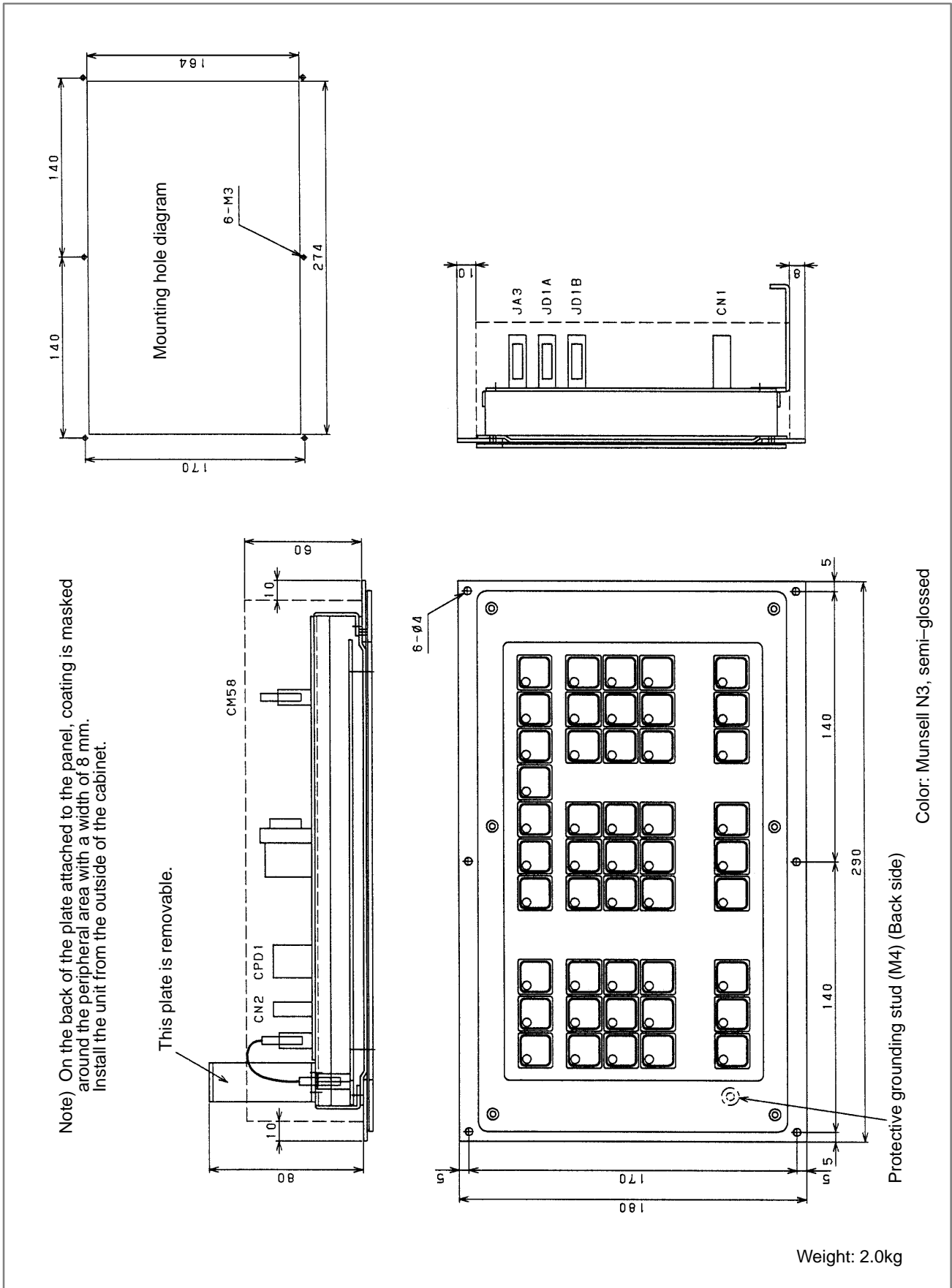

Fig. U39 Distributed I/O machine operator's panel (290 mm wide)

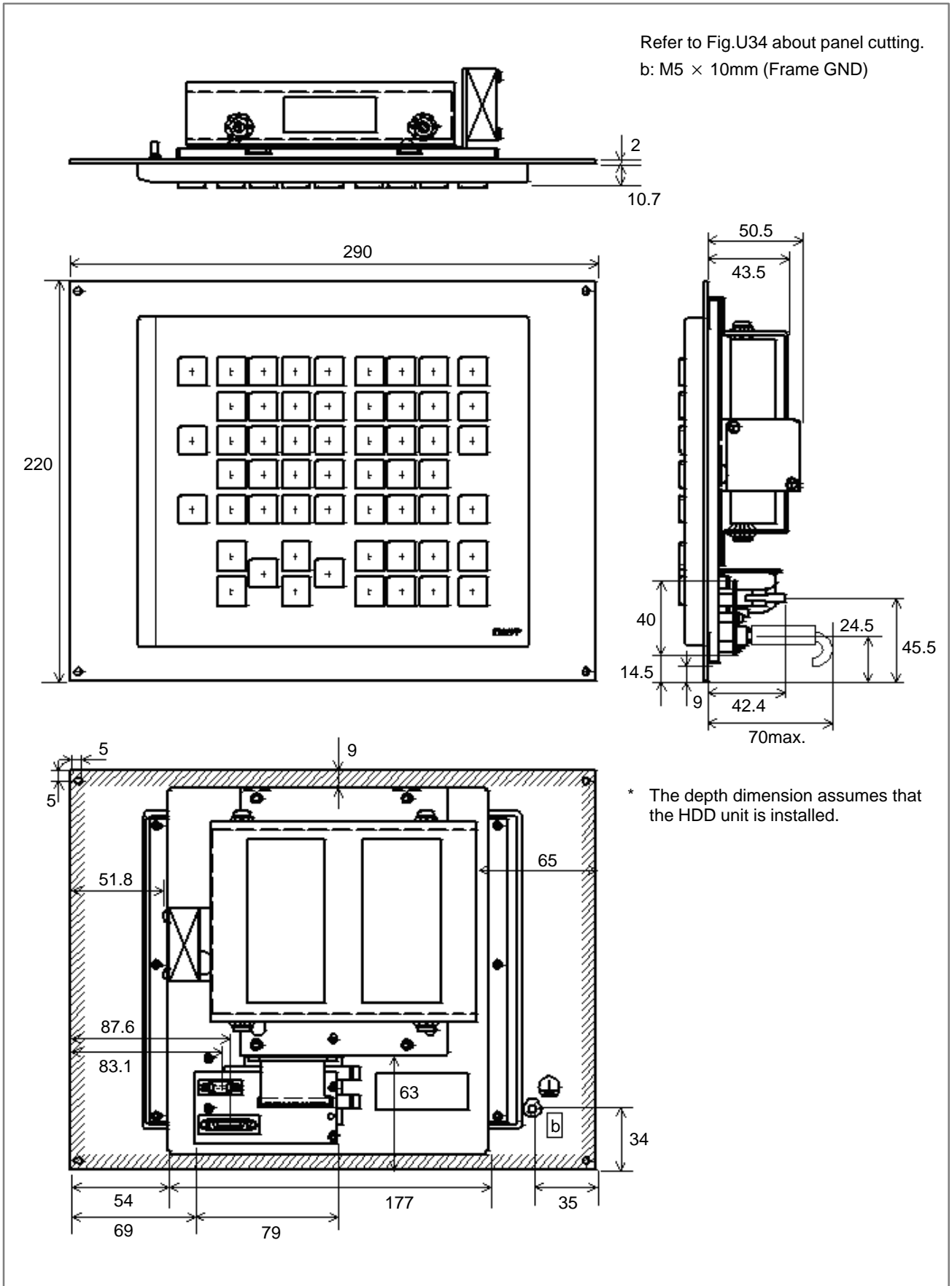

Fig. U40(a) Stand-alone type standard MDI unit for 160i/180i/210i (10.4" LCD, vertical type)

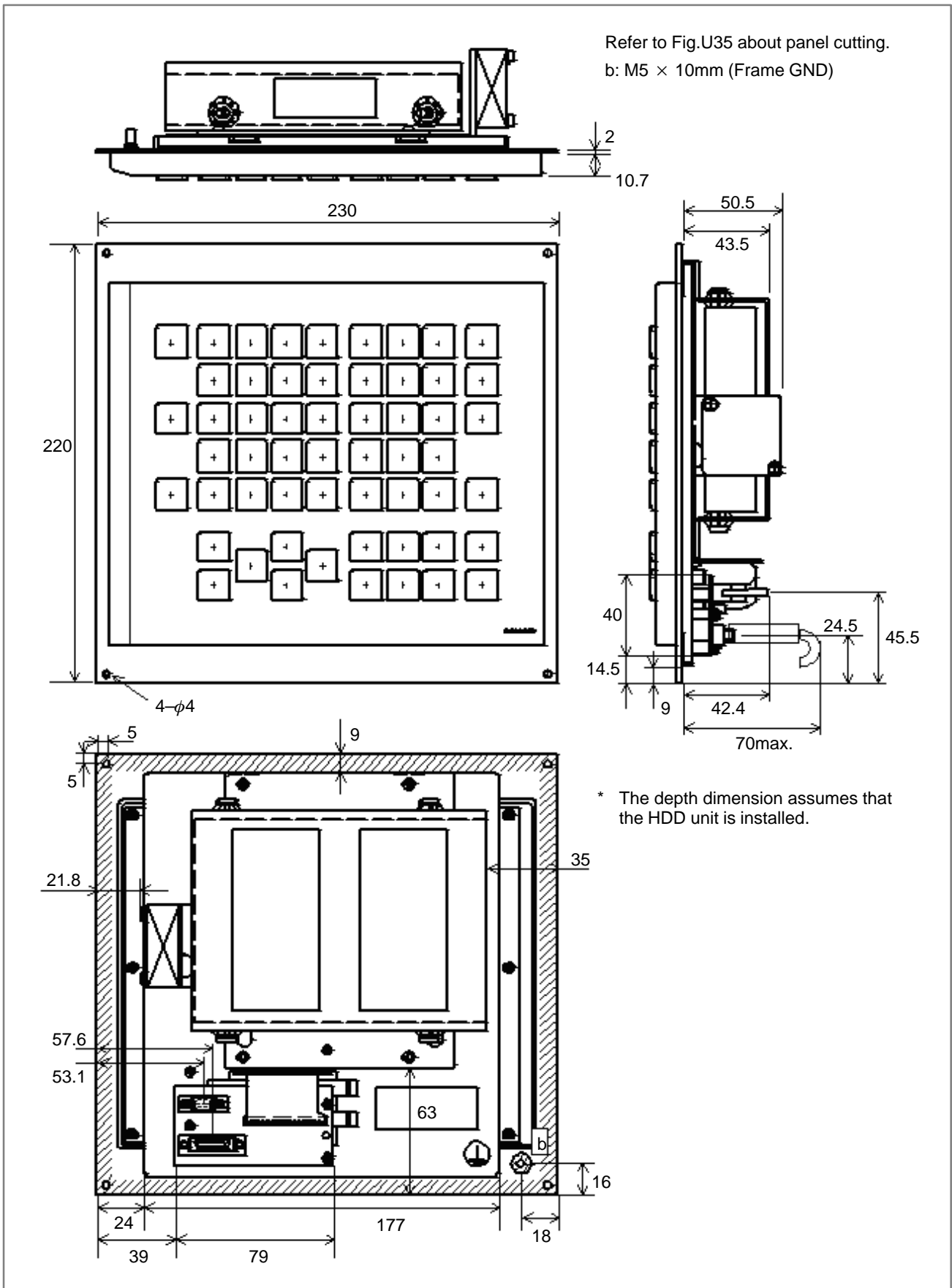

Fig. U40(b) Stand-alone type standard MDI unit for 160i/180i/210i (10.4" LCD, horizontal type)

[Symbols]

α i Servo Information Screen, 394
 α i Spindle Information Screen, 395

[Numbers]

1-block Plural M Command, 135
 160i/180i/210i, 448
 160is/180is/210is, 450
 2nd, 3rd and 4th Reference Position Return (G30), 97
 3-dimensional Circular Interpolation (G02.4 and G03.4), 75
 7.2"/8.4" LCD-mounted Type CNC Control Unit, 345
 9.5"/10.4" LCD-mounted Type CNC Control Unit, 346

[A]

Abnormal Load Detection, 437
 Absolute and Incremental Programming (G90, G91), 115
 Acceleration/Deceleration and Automatic Phase Synchronization, 309
 Acceleration/Deceleration Before Interpolation by Pre-reading Multiple Blocks, 280
 Acceleration/Deceleration Type, 308
 Accuracy Compensation Function, 225
 Activation of Automatic Operation, 333
 Actual Spindle Speed Output (T series), 121
 Addition of Tool Pairs for Tool Life Management <512 Pairs (M series) / 128 Pairs (T series)>, 132
 Additional Optional Block Skip, 144
 Additional Workpiece Coordinate Systems (M series), 110
 Adifference Among Pitch Error Compensation, Inclination Compensation, and Straightness Compensation, 231
 Advanced Preview Control (G08), 275
 AI Advanced Preview Control (for the 21i-M Only) (G05.1) (M series), 285
 AI Contour Control (G05.1) (M series), 282
 AI High-precision Contour Control AI Nano High-precision Contour Control, 283
 AI Nano Contour Control (G05.1), 285
 Alarm Signal, 440
 All Axes Interlock, 436

All-axes Machine Lock, 342
 Angular Axis Control, 299
 Applicable Machines, 461, 468
 Arbitrary Angular Axis Control, 299
 Automatic Acceleration/Deceleration, 85
 Automatic Coordinate System Setting, 105
 Automatic Corner Deceleration, 273
 Automatic Corner Override (G62) (M series), 91
 Automatic Operation, 330
 Automatic Operation Signal, 440
 Automatic Operation Start Signal, 440
 Automatic Operation Stop, 334
 Automatic Reference Position Return (G28, G29) (M series), 96
 Automatic Tool Offset (G37, G36) (T series), 246
 Automatic Velocity Control Function, 281
 Auxiliary Function Lock, 342
 Axes Control, 289
 Axis Control by PMC, 37
 Axis Control with PMC, 298
 Axis Move Direction Signal, 441
 Axis Names, 38
 Axis Recomposition (T series), 321

[B]

B-axis Control (T series), 299
 Background Drawing (M series), 367
 Background Editing, 397
 Backlash Compensation, 233
 Backlash Compensation Specific to Rapid Traverse and Cutting Feed, 233
 Balance Cut (G68, G69) (T series), 320
 Basic Addresses and Command Value Range, 142
 Bell-shaped Acceleration/Deceleration After Cutting Feed Interpolation, 88
 Bi-directional Pitch Error Compensation, 226
 Block Start Interlock, 436
 Buffer Register, 333
 Butt-type Reference Position Setting, 99

[C]

C Language Executer Function, 264
 Canceling Alarm 101, 523

-
- Canned Cycles (G73, G74, G76, G80–G89, G98, G99) (M series), 146
 - Canned Cycles for Cylindrical Grinding (T series), 183
 - Canned Cycles for Drilling (G80–G89) (T series), 174
 - Canned Cycles for Turning (T series), 159
 - Chamfering and Corner R (T series), 175
 - Changing of Tool Offset Amount (Programmable Data Input) (G10), 213
 - Chopping Function (G80, G81.1) (M series), 301
 - Chuck/Tail Stock Barrier (T series), 433
 - Circular Interpolation (G02, G03), 54
 - Circular Threading (G35, G36) (T series), 79
 - Clearing All Memory Data, 523
 - Clearing the Screen, 379
 - Clock Function, 357
 - Color Setting Screen, 381
 - Constant Surface Speed Control, 121
 - Constant Surface Speed Control Signal, 441
 - Continuous Feed Plane Grinding Cycle (G78), 190
 - Continuous High-speed Skip Function (G31, P90) (M series), 244
 - Continuous Thread Cutting (T series), 79
 - Contrast Adjustment Screen, 382
 - Control Axis Detach, 290
 - Control-in/Control-out, 144
 - Controlled Axes, 34
 - Conversational Automatic Programming Function for Lathes, 460
 - Conversational Automatic Programming Function for Machining Centers, 482
 - Conversational Programming of Figures (Only at 1-path Control), 399
 - Coordinate System Conversion, 236
 - Coordinate System Rotation (G68, G69) – (M series) (G68.1, G69.1) – (T series), 237
 - Coordinate Systems, 101
 - Coordinate Value and Dimension, 114
 - Copying a Program Between Two Paths, 323
 - Corner Circular Interpolation Function (G39) (M series), 208
 - Corner Circular Interpolation Function (G39) (T series), 203
 - Count Input of Tool Offset Values (T series), 253
 - Counter Input in a Workpiece Coordinate System, 107
 - Cs Contour Control, 37, 125
 - Custom Macro, 254, 255
 - Cutter Compensation (M series), 206
 - Cutter Compensation B (G40–42), 206
 - Cutter Compensation C (G40–G42), 206
 - Cutting Block Start Interlock, 436
 - Cutting Cycle A (G77) (with G Code System A: G90), 159
 - Cutting Feed Rate, 82
 - Cutting Feed Rate Clamp, 82
 - Cutting Mode (G64) (M series), 91
 - Cycle Start, 333
 - Cylindrical Interpolation (G07.1), 60
 - Cylindrical Interpolation Cutting Point Compensation (G07.1) (M series), 62
-
- [D]**
- Data Input/Output, 402
 - Data Input/Output Function Based on the I/O Link and Data Input/Output Function B Based on the I/O Link, 422
 - Data Input/Output Using a Memory Card, 405
 - Data Protection Key, 376
 - Data Server Function, 413
 - Decimal Point Input/Pocket Calculator Type Decimal Point Input, 117
 - DI Status Output Signal, 441
 - Diagnosis Functions, 400
 - Diameter and Radius Programming (T series), 117
 - Direct Drawing Dimensions Programming (T series), 178
 - Direct Input of Tool Compensation Measured Value/ Direct Input of Workpiece Coordinate System Shift Amount (T series), 248
 - Direct Input of Workpiece Zero Point Offset Value Measured, 253
 - Direction Decision Type High-speed Position Switch, 442
 - Directory Display and Punch for a Specified Group, 379
 - Directory Display of Floppy Cassette, 360
 - Display, 354
 - Display Screen, 479, 493
 - Displaying and Setting Data, 353
 - Displaying Operation History, 376
 - Distribution End Signal, 440
 - DNC Operation, 331
 - DNC1 Control, 407
 - DNC1/Ethernet Function, 411

DNC1/Ethernet function, 418
 DNC2 Control (Only at 1-path Control), 408
 Dry Run, 342
 Dwell (G04), 92
 Dynamic Graphic Display, 362

[E]

Electric Gear Box Automatic Phase Synchronization (M series), 308
 Electric Gear Box Two Pair (M series), 306
 Embedded Ethernet and PCMCIA Ethernet, 415
 Embedded Ethernet Function, 415
 Embedded Macros, 265
 Embedded Milling Macro (M series), 267
 Emergency Stop, 426
 Equal lead thread cutting (G33) (with G code system A: G32), 77
 Error Detection (T series), 90
 Ethernet Function (Option Board), 409
 Exact Stop (G09) (M series), 91
 Exact Stop Mode (G61) (M series), 91
 Execution of Automatic Operation, 333
 Expanded External Workpiece Number Search, 332
 Expanded Part Program Editing, 398
 Explanation of the Function Keys, 351
 Explanation of the Keyboard, 350
 Explanation of the Soft Keys, 352
 Exponential Function Interpolation (G02.3, G03.3) (M series), 67
 Extended Tool Life Management (M series), 132
 External Alarm Message, 445
 External Control of I/O Device, 398
 External Data Input, 443
 External Deceleration, 437
 External Dimensions of Each Unit, 549
 External Machine Zero Point Shift, 444
 External Memory and Sub Program Calling Function, 141
 External Operation Function (G81) (M series), 158
 External Operator's Message, 445
 External Program Input, 404
 External Program Number Search, 444
 External Tool Compensation, 444

External Touch Panel Interface, 380
 External Workpiece Coordinate System Shift, 444
 External Workpiece Number Search, 332
 Externally Setting the Stroke Limit, 432

[F]

FACTOLINK Function, 412
 FACTOLINK function, 416
 FACTOLINK Parameter Setting Screen, 383
 FANUC Floppy Cassette, 404
 FANUC Handy File, 404
 FANUC Program File Mate, 404
 FANUC Servo Motor β Series I/O Link Option Manual Handle Interface (Peripheral Equipment Control), 456
 Feed Functions, 80
 Feed Hold, 334
 Feed Hold Signal, 440
 Feed Rate Override, 84
 Feed Stop, 293
 Feedrate Clamp by Circular Radius (M series), 274
 Field Networks, 424
 Figure Copying (G72.1, G72.2) (M series), 195
 Fine Torque Sensing, 437
 Finishing Cycle (G70), 169
 Flexible Synchronization Control Function (M series), 312
 Floating Reference Position Return (G30.1), 98
 FOCAS1/Ethernet Function, 410
 FOCAS1/Ethernet function, 417
 FOCAS1/Ethernet Parameter Setting Screen, 386
 Follow up Function, 290
 Foreground Editing, 397
 FTP file transfer function, 420
 FTP File Transfer Parameter Setting Screen, 390
 Function Keys and Soft Keys, 521
 Functional differences between the embedded Ethernet function and the Ethernet function based on the option board, 420
 Functions and Tape Format List, 534
 Functions for High Speed Cutting, 270
 Functions Specific to 2-path Control, 315
 Functions to Simplify Programming, 145

[G]

General-purpose Retraction, 314

Graphic Display Function, 361
 Grinding wheel wear Compensation (G40, G41) (M series), 217
 Grinding-wheel wear Compensation by Continuous Dressing (M series), 215
 Grooving in X-axis (G75), 171
 Guidance Programming Function, 516

[H]

Handle Feed in the Same Mode as for Jog Feed, 326
 Helical Interpolation (G02, G03), 56
 Helical Interpolation B (G02, G03) (M series), 57
 Help Function, 374
 High-precision Contour Control (Only at One-Path Control) (M series), 280
 High-Speed Cycle Machining (Only at 1-path Control), 271
 High-speed Cycle Machining (only at one-path), 271
 High-Speed Cycle Machining Skip Function, 272
 High-speed Linear Interpolation (G05), 282
 High-speed M/S/T/B Interface, 136
 High-speed Position Switch, 442
 High-speed Remote Buffer A (G05) (Only at 1-path Control), 278
 High-speed Remote Buffer B (G05) (Only at 1-path Control) (M series), 279
 High-speed Serial Bus (HSSB), 453
 High-speed Skip Signal Input, 244
 Hob, 302
 Hobbing Function (G80.4, G81.4) (T series), 303
 Hobbing Machine Function (G80, G81) (M series), 302
 Hypothetical Axis Interpolation (G07), 70

[I]

ID Information Screen, 394
 In-position Signal, 440
 Inch Input Signal, 441
 Inch/Metric Conversion (G20, G21), 117
 Inclination Compensation, 228
 Increased Custom Macro Common Variables, 261
 Increment System, 39
 Incremental Feed, 325
 Index Table Indexing (M series), 182

Infeed Control (M series), 194
 Input Unit (10 Times), 40
 Input/Output Devices, 404
 Interface with the Power Mate CNC, 455
 Interlock, 436
 Interlock for Each Axis Direction, 436
 Interlock per Axis, 436
 Intermittent Feed Plane Grinding Cycle (G79), 192
 Interpolated Straightness Compensation, 235
 Interpolation Functions, 50
 Interpolation Type Pitch Error Compensation, 227
 Interruption Type Custom Macro, 261
 Inverse Time Feed (G93) (M series), 83
 Involute Interpolation (G02.2, G03.2) (M series), 65
 Involute Interpolation Automatic Feedrate Control Function (M series), 66

[J]

Jog Feed, 325
 Jog Override, 84

[K]

Key Input from PMC (External Key Input), 446

[L]

Label Skip, 144
 Language Selection, 357
 Leading Edge Offset, 222
 Linear Acceleration/Deceleration After Cutting Feed Interpolation, 87
 Linear Acceleration/Deceleration Before Cutting Feed Interpolation, 89
 Linear Axis and Rotation Axis, 118
 Linear Copy (G72.2), 197
 Linear Interpolation (G01), 53
 Linear Interpolation G28, G30, and G53, 100
 Linear Scale Expansion Function with Absolute Addressing Reference Marks, 100
 Linear Scale with Absolute Addressing Reference Marks, 100
 List of Functions, 416
 List of Specifications, 8, 500
 List of Tape Code, 546

Loader Controlled Axes, 38
 Local Coordinate System (G52), 108
 Look-Ahead Bell-Shaped Acceleration/Deceleration Before Interpolation Time Constant Change Function (M series), 286

[M]

M Code Group Check Function, 137
 M series, 46, 531, 540
 Machine Controlled Axes, 36
 Machine Coordinate System (G53), 102
 Machine Lock on Each Axis, 342
 Machining Guidance Function, 512
 Machining Time Stamp Function, 376
 Macro Executer Function, 263
 Main Program, 139
 Maintenance Information Screen, 381
 Manual Absolute On/Off, 326
 Manual Guide, 475, 491
 Manual Handle Feed, 520
 Manual Handle Feed (1st), 325
 Manual Handle Feed (2nd, 3rd) (T series: 2nd), 325
 Manual Handle Interruption, 337
 Manual Handle Retrace (T series), 343
 Manual Interruption During Automatic Operation, 337
 Manual Intervention and Return, 336
 Manual Linear/Circular Interpolation (Only at 1-path Control), 328
 Manual Numeric Command, 329
 Manual Operation, 324
 Manual Per-rotation Feed (T series), 326
 Manual Reference Position Return, 95
 Maximum Stroke, 41
 MDI Operation, 331
 Measurement Cycle (M series), 267
 Measurement Functions, 242
 Mechanical Handle Feed, 290
 Memory Common to Paths, 320
 Memory Operation, 331
 Mirror Image, 290
 Mirror Image for Double Turrets (G68, G69) (T series), 181
 Miscellaneous Functions, 134, 135
 Move Signal, 440

Multi-spindle Control, 126
 Multi-step Skip Function (G31 P1-G31 P4), 244
 Multiple Repetitive Cycles for Turning (G70-G76) (T series), 163
 Multiple-thread cutting (G33) (T series), 78

[N]

NC Functions of 20i, 519
 NC Ready Signal, 440
 Normal Direction Control (G40.1,G41.1,G42.1) (M series), 294
 Number of Basic Controlled Axes, 36
 Number of Basic Simultaneously Controlled Axes, 36
 Number of Controlled Axes Expanded (All), 36
 Number of Controlled Paths, 36
 Number of Registered Programs, 398
 Number of Simultaneously Controlled Axes Expanded (All), 37
 Number of the All Controlled Axes, 35
 Number of Tool Offsets, 212
 Number of Tool Offsets (M series), 212
 Number of Tool Offsets (T series), 212
 Nurbs Interpolation (G06.2), 73

[O]

One-digit F Code Feed (M series), 83
 One-touch Macro Call, 444
 Operation, 478, 492
 Operation Mode, 331
 Optimum Torque Acceleration/Deceleration, 288
 Optional Angle Chamfering/Corner Rounding (M series), 177
 Optional Block Skip, 144
 Oscillation Direct Gauge Grinding Cycle (G74) , 185
 Oscillation Grinding Cycle (G73) , 185
 Other Optional Functions, 488
 Other Rigid Tapping Functions (M series), 157
 Outline of Conversational Automatic Programming, 459
 Outline of Hand CNC (Series 20i), 499
 Outline of the Conversational Automatic Programming Function, 462, 469, 485
 Outline of the Macro Library, 483
 Override, 84
 Override Cancel, 84

Overtravel, 428

Overtravel Functions, 428

[P]

Part Program Storage and Editing, 396
 Part Program Storage Length, 398
 Password Function, 399
 Pattern Data Input, 262
 Pattern Repeating (G73), 168
 Peck Drilling in Z-axis (G74), 170
 Per Minute Feed (G94) (G98 for G-code System A), 82
 Per Revolution Feed (G95) (G99 for G-code System A), 83
 Periodic Maintenance Screen, 380
 Personal Computer Function, 447
 Plane Selection (G17, G18, G19), 113
 Play Back, 398
 Plunge Direct Grinding Cycle (G77), 189
 Plunge Grinding Cycle (G75), 187
 Polar Coordinate Command (G15, G16) (M series), 116
 Polar Coordinate Interpolation (G12.1, G13.1), 58
 Polygonal Turning (G50.2, G51.2) (T series), 296
 Polygonal Turning with Two Spindles (T series), 298
 Position Switch Function, 441
 Positioning (G00), 51
 Positioning by Optimum Acceleration, 92
 Power Mate CNC Manager, 423
 Preparatory Functions, 42
 Program Configuration, 138
 Program End (M02, M30), 334
 Program Name, 139
 Program Number, 139
 Program Number Search, 332
 Program Restart, 335
 Program Stop (M00, M01), 334
 Program Test Functions, 341
 Programmable Mirror Image (G50.1, G51.1) (M series), 180
 Programmable Parameter Entry (G10, G11), 234

[R]

Range of Command Value, 527
 Rapid Traverse, 81
 Rapid Traverse Bell-shaped Acceleration/Deceleration, 86
 Rapid Traverse Block Overlap, 93
 Rapid Traverse Override, 84
 Rapid Traversing Signal, 441
 Reader/Punch Interfaces, 403
 Reference Position, 94
 Reference Position Return Check (G27), 97
 Reference Position Shift, 99
 Remote Buffer, 276
 Remote Buffer (Only at 1-path Control), 276
 Remote Diagnosis, 377
 Reset, 334
 Reset Signal, 440
 Restart of Automatic Operation, 335
 Retrace Function (M series), 339
 Rewind, 332
 Rewinding Signal, 440
 Rigid Tapping, 152
 Rigid Tapping Bell-shaped Acceleration/Deceleration (M series), 156
 Rigid Tapping by Manual Handle Feed (M series), 328
 Rigid Tapping Return (M series), 340
 Rigid Tapping Return by Specifying G30, 340
 Rotary Axis Control, 118
 Rotary Table Dynamic Fixture Offset, 224
 Rotation Area Interference Check, 435
 Rotation Axis Roll-over Function, 118
 Rotation Copy (G72.1), 196
 Run Time & Parts Number Display, 357

[S]

S Code Output, 120
 Safety Functions, 425
 Scaling (G50, G51) (M series), 239
 Scheduling Function, 338
 Screen Hard Copy, 406
 Screens for Servo Data and Spindle Data, 369
 Second Feed Rate Override, 84
 Second Miscellaneous Functions, 135

-
- Selection of Execution Programs, 332
 - Self Diagnosis Functions, 401
 - Sequence Number, 141
 - Sequence Number Comparison and Stop, 334
 - Sequence Number Search, 332
 - Serial Spindle Advanced Control, 128
 - Series 15 Tape Format, 269
 - Series 15 Tape Format/Series 10/11 Tape Format, 268
 - Series-10/11 Tape Format, 269
 - Servo Adjustment Screen, 369
 - Servo Off, 290
 - Servo Ready Signal, 440
 - Servo Setting Screen, 369
 - Servo Waveform Function, 368
 - Servo/Spindle Motor Speed Detection, 438
 - Setting a Workpiece Coordinate System (Using G54 to G59), 106
 - Setting a Workpiece Coordinate System (Using G92) (with G Code System A: G50), 103
 - Setting and Display Unit, 344, 345
 - Setting the Embedded Ethernet Function, 383
 - Setting the Reference Position without Dogs, 95
 - Simple Electric Gear Box (G80, G81) (M series), 304
 - Simple Spindle Synchronous Control, 127
 - Simple Synchronous Control, 291
 - Simultaneous Input and Output Operations (Only at 1-path Control) (M series), 339
 - Single Block, 342
 - Single Direction Positioning (G60) (M series), 52
 - Skip Function (G31), 243
 - Skip Function for EGB Axis, 305
 - Smooth Interpolation (G05.1) (Only at 1-Path Control) (M series), 69
 - Software Operator's Panel, 358
 - Special Key Operations, 523
 - Spindle Adjustment Screen, 370
 - Spindle Electric Gear Box (M series), 310
 - Spindle Functions, 119
 - Spindle Monitor Screen, 371
 - Spindle Orientation, 127
 - Spindle Output Control by the PMC, 120
 - Spindle Output Switching, 127
 - Spindle Override, 121
 - Spindle Position Data Display, 128
 - Spindle Positioning (T series), 122
 - Spindle Setting Screen, 370
 - Spindle Speed Analog Output (S Analog Output), 120
 - Spindle Speed Fluctuation Detection (G25, G26), 123
 - Spindle Speed Serial Output (S Serial Output), 120
 - Spindle Synchronization Control, 127
 - Spiral Interpolation, Conical Interpolation (M series), 71
 - Stand-alone Type Small MDI Unit, 347
 - Stand-alone Type Standard MDI Unit (Horizontal Type), 348
 - Stand-alone Type Standard MDI Unit (Vertical Type), 349
 - Start Lock, 436
 - Status Output, 439
 - Stock Removal in Facing (G72), 167
 - Stock Removal in Turning (G71), 163
 - Stored Pitch Error Compensation, 226
 - Stored Stroke Check 1, 428
 - Stored Stroke Check 2 (G22, G23) (M series), 429
 - Stored Stroke Checks 2 and 3 (G22, G23) (T series), 430
 - Stored Stroke Checks 3 (M series), 429
 - Straightness Compensation, 228
 - Stroke Limit Check Before Movement, 431
 - Sub Program, 140
 - Substitution of the Number of Required Parts and Number of Machined Parts, 445
 - Super CAPi M, 483
 - Super Capi T, 468
 - Supported Machine Tools, 477
 - Surface Grinding Canned Cycle (M series), 186
 - Symbol Capi T, 461
 - Synchronization Control (Only at 1-path Control) (T series), 292
 - System Configuration Display Function, 372
 - System in Which a commercially Available Personal Computer and the CNC are Connected Via the High-Speed Serial BUs, 454
-
- [T]**
- T Code Output, 130
 - T series, 43, 528, 535
 - Tandem Control, 300
 - Tangential Speed Constant Control, 82
 - Tape Codes, 141
 - Tape Format, 144

Tape Horizontal (TH) Parity Check and Tape Vertical (TV) Parity Check, 144

Tapping Mode (G63) (M series), 91

Tapping Signal, 441

Temporary Absolute Coordinate Setting, 313

The Stop Position Setting with the Manual Feed (T series), 329

Thread cutting, 76

Thread Cutting Cycle (G76), 172

Thread Cutting Cycle (G78) (with G Code System A: G92), 160

Thread Cutting Cycle Retract (T series), 334

Thread Cutting Signal, 441

Three-dimensional Coordinate Conversion (G68, G69) (M series), 241

Three-dimensional Cutter Compensation, 221

Three-dimensional Rigid Tapping, 157

Three-dimensional Tool Compensation (G40, G41) (M series), 216

Three-spindle Serial/Four Output, 127

Tool Axis Direction Handle Feed, 327

Tool Axis Direction Handle Feed and Tool Axis Direction Handle Feed B, 327

Tool Axis Direction Tool Length Compensation, 218

Tool Axis Normal Direction Handle Feed, 327

Tool Center Point Control, 223

Tool Compensation Function, 198

Tool Compensation Memory, 209

Tool Compensation Memory (M series), 209

Tool Compensation Value Measured Value Direct Input B, 249

Tool Functions, 129

Tool Geometry Compensation and Tool Wear Compensation, 200

Tool Length Automatic Measurement (G37) (M series), 245

Tool length Compensation (G43, G44, G49) (M series), 204

Tool Length Measurement (M series), 247

Tool Length/Workpiece Origin Measurement B (M series), 253

Tool Life Management, 131

Tool Life Management B (M series), 133

Tool Nose Radius Compensation (G40, G41, G42) (T series), 201

Tool Offset (G45, G46, G47, G48) (M series), 205

Tool Offset (T Code), 199

Tool Offset (T series), 199

Tool Offset Amount Memory (T series), 210

Tool Post Interference Check (T series), 319

Tool Retract & Recover, 335

Tool Side Compensation, 221

Torque Limit Skip (G31 P99, G31 P98), 244

Touch Panel, 380

Traverse Direct Gauge Grinding Cycle (G72), 184

Traverse Grinding Cycle (G71), 184

Turning Cycle in Facing (G79) (with G Code System A: G94), 162

[V]

Variable lead thread cutting (G34) (T series), 78

[W]

Waiting Function, 318

Workpiece Coordinate System, 103

Workpiece Coordinate System Preset (G92.1), 111

Workpiece Coordinate System Shift (T series), 112

Workpiece Origin Offset Value Change (Programmable Data Input) (G10), 109

[Y]

Y Axis Offset, 200

Revision Record

FANUC Series 16i/160i/160is/18i/180i/180is/21i/210i/210is/20i--MODEL B DESCRIPTIONS (B--63522EN)

03	Sep., 2004	<ul style="list-style-type: none"> • Addition of Series 20i--TB/FB • Modifications have been made, including updating of the function list. 							
02	Oct., 2001	<p>Addition of following models:</p> <ul style="list-style-type: none"> • Series 160i/180i/210i--TB/MB • Series 18i/180i/180is--MB5 <p>Addition of following functions:</p> <ul style="list-style-type: none"> • Interpolated straightness compensation • Look-ahead bell-shaped acceleration/deceleration before interpolation time constant change function • Optimum torque acceleration/deceleration • Rotation area interference check • ID information screen <p>Modifying of descriptions of following items:</p> <ul style="list-style-type: none"> • List of specifications • Setting the embedded Ethernet function • Embedded Ethernet function • Personal computer function <p>Appendices D to G have been organized into APPENDIX D, "OUTLINE DRAWINGS OF UNITS."</p>							
01	Apr., 2001	_____							
Edition	Date	Contents	Edition	Date	Contents	Edition	Date	Contents	

